

**SCHWINN**

A World of Daily Innovation

# Program Magazynowy 2021

Stock Program 2021

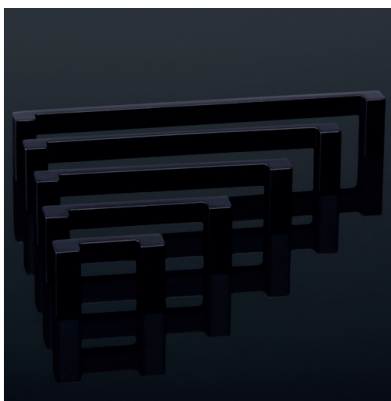

# Zawartość

## Contents

Aluminium / Aluminium 5 - 8

Metal / Metal 9 - 32

Dla dzieci / For children 33 - 38

Specjalne / Specials 39 - 48

# Aluminium





3857 **BIS**





3857 **IN**



3857 **IN**



3857 **IN**

Art. Nr / Art.-No.	Wykonanie / Finish				+...+
1 3857	<b>IN</b> <b>BIS</b>	136	20	32	128
		168	20	32	160
		200	20	32	192
		232	20	32	224
		264	20	32	256
		328	20	32	320
		424	20	32	416
		520	20	32	512
		628	20	32	608









3748 



3748 



3748 

Art. Nr / Art.-No.	Wykonanie / Finish				+...+
		146	11	37	-
		196	11	37	-
		246	11	37	-
		296	11	37	-
		346	11	37	-
		396	11	37	-
2	3748 	446	11	37	-
		496	11	37	-
		596	11	37	-
		696	11	37	-
		896	11	37	-
		996	11	37	-
		1096	11	37	-
		1196	11	37	-



4394 

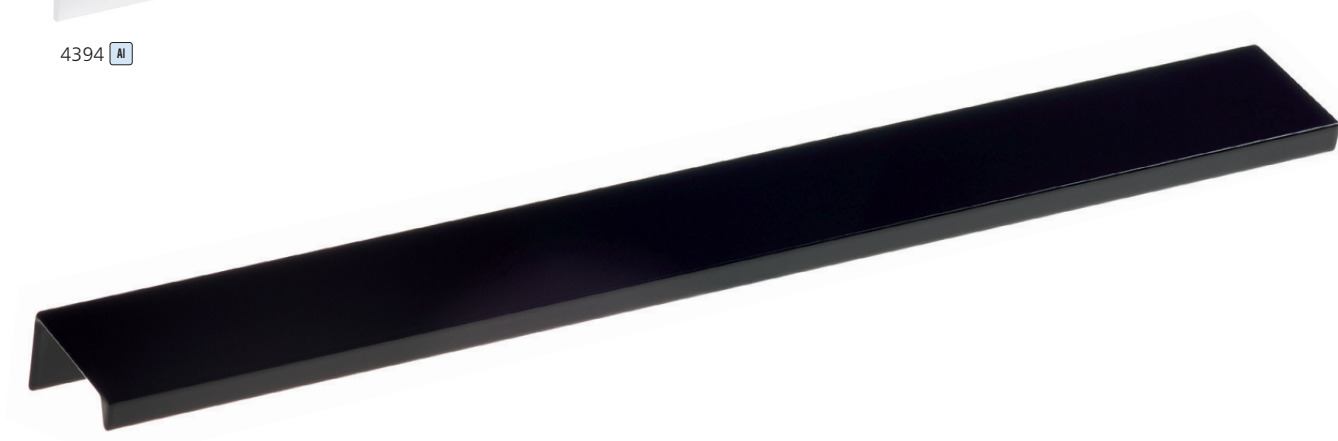



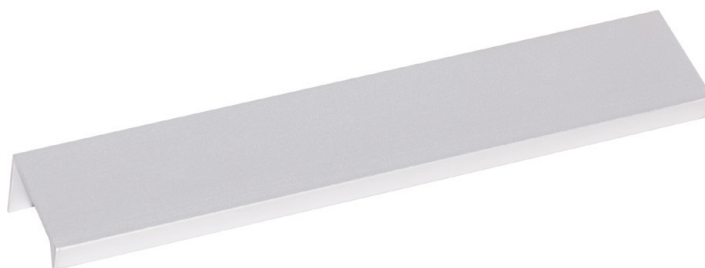

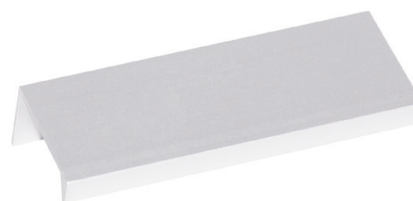
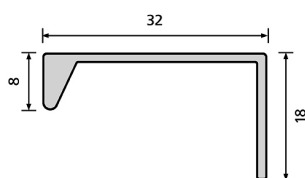

4394 



4394 



4394 

Art. Nr / Art.-No.	Wykonanie / Finish				
3 4394	  	52	18	32	32
		84	18	32	64
		116	18	32	96
		148	18	32	128
		180	18	32	160
		212	18	32	192
		276	18	32	256
		340	18	32	320

# Metal







2389 **St**



2389 **BIP**











2389 **WhP**



2389 **CrM**



2389 **Cr**

Art. Nr / Art.-No.	Wykonanie / Finish				+...+
4 2389	    	104	18	30	96
		135	20	30	128
		168	20	30	160
		200	20	30	192
		264	20	30	256
		330	20	30	320
		392	20	30	384
		488	20	30	480





2576 **BIP**



2576 **WhP**



2576 **Cr**



2576 **GM**



2576 **NiM**

Art. Nr / Art.-No.	Wykonanie / Finish				
5 2576		113	8	27	96
		150	8	27	128
		186	9	27	160
		222	9	28	192
		290	9	28	256
		359	9	28	320
		518	9	28	480



Z003 **WhP**





Z003 **BIS**



Z011 **Cr**



Z011 **BIP**

Art. Nr / Art.-No.	Wykonanie / Finish				+...+
6 Z003	<b>BIS</b> <b>WhP</b>	80	80	22	64
7 Z011	<b>Cr</b> <b>BIP</b>	249	10	29	160/224



2516 **Cr**



2516 **NIM**



2516 **St**



2516 **WhP**



2516 **Cr**



2516 **BIP**

Art. Nr / Art.-No.	Wykonanie / Finish				
8 2516	<b>Cr</b>	136	10	28	128
	<b>St</b>	200	10	28	192
	<b>BIP</b>	328	10	29	320



Z077  Cr

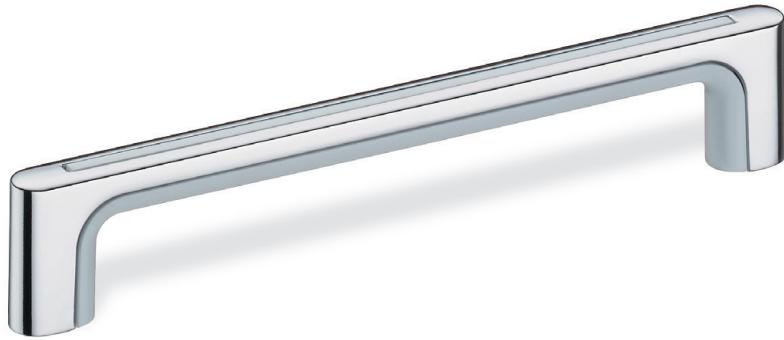

Z077  Cr



Z077  Cr



Z077  Cr

Art. Nr / Art.-No.	Wykonanie / Finish				t...+
9 Z077	<input checked="" type="checkbox"/> Cr <input type="checkbox"/> Cr	108	12	32	96
		172	12	32	160
		236	12	32	224





Z040 

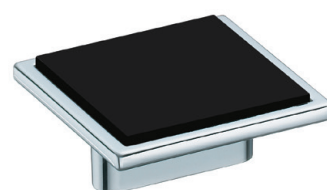







Z030 



Z324 



Z324 

	Art. Nr / Art.-No.	Wykonanie / Finish				t+...+
10	Z040		184	25	27	160
11	Z030		58	58	23	32
12	Z324	 	246	18	36	192



Z008 **Cr**







Z008 **Cr**



Z008 **BIM**



Z008 **BIM**

Art. Nr / Art.-No.	Wykonanie / Finish				
13 Z008	<b>Cr</b>	107	21	26	96
	<b>BIM</b>	267	25	26	256



2084 **GM**



2084 **BIM**



Z010 **CrM**



Z010 **Cr**



Z010 **BIS**



Z010 **WhP**



Z072 **Cr**

Art. Nr / Art.-No.	Wykonanie / Finish				∅	+...+
14 2084	<b>BIM</b> <b>GM</b>	230	8	30	192	
15 Z072	<b>Cr</b> <b>St</b>			27	106	96
16 Z010	<b>CrM</b> <b>Cr</b> <b>BIS</b> <b>WhP</b>	74	37	19		64



Z245 Cr







Z245 St



2225 WHP





2225 BIS

	Art. Nr / Art.-No.	Wykonanie / Finish				
17	Z245	Cr St	80	46	20	64
18	2225	BIS WHP	182	30	25	128

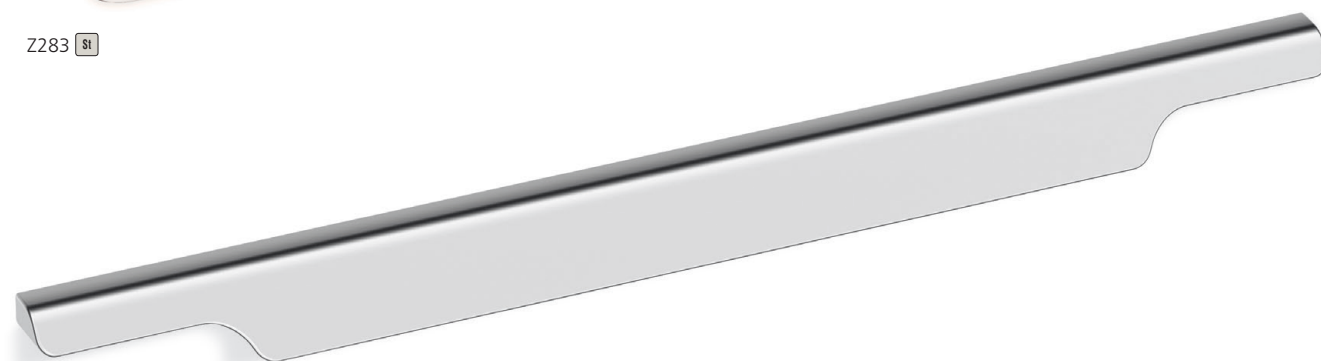

Z283 CrZ283 StZ087 Cr

	Art. Nr / Art.-No.	Wykonanie / Finish				+...+
19	Z283	<span>Cr</span> <span>St</span>	180	25	19	160
			340	25	19	320
20	Z087	<span>Cr</span>	380	24	22	320+352



Z273 BIM







Z273 WhP



2891 BIS



2891 BIS

Art. Nr / Art.-No.	Wykonanie / Finish				
21 Z273	BIM WhP	174	14	31	160
		42	9	20	32
		75	9	20	64
22 2891	BIS	107	9	20	96
		140	9	20	128
		202	9	20	192



2930 **Cr**

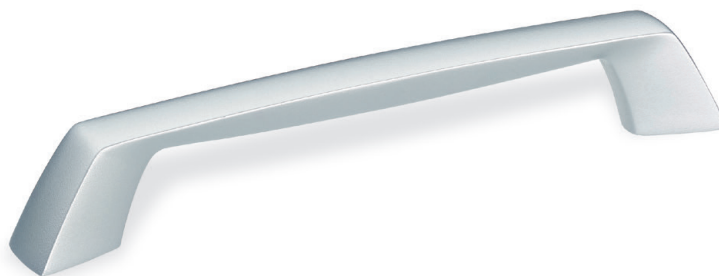

2930 **CrM**



2930 **NiB**



Z162 **BIS**



Z162 **WhP**

Art. Nr / Art.-No.	Wykonanie / Finish				+...+
23 2930	<b>CrM</b> <b>Cr</b> <b>NiB</b>	120	15	30	96
		192	19	32	160
		350	19	32	320
24 Z162	<b>BIS</b> <b>WhP</b> <b>GM</b>	150	22	25	128



Z306 **BIS**



Z306 **BIS**

Art. Nr / Art.-No.	Wykonanie / Finish				
25 Z306	<b>BIS</b>	42	10	28	32
		74	10	29	64
		106	10	30	96
		138	10	30	128
		171	11	30	160





Z299 **GM**



Z299 **BIM**



Z133 **St**



Z133 **BIP**

	Art. Nr / Art.-No.	Wykonanie / Finish				
26	Z299	<b>BIM</b> <b>GM</b>	221	33	32	160
27	Z133	<b>St</b> <b>BIP</b>	178	10	34	160



2342 BIP



2342 MIA



2342 GM



2342 G



2342 Gr



2342 WhP



2342 MIA

Art. Nr / Art.-No.	Wykonanie / Finish				
28 2342		123	18	29	96
		170	25	33	128



Z285 BIP



Z285 NIA



Z303 BIP



Z303 GM

Art. Nr / Art.-No.	Wykonanie / Finish				+...+
29 Z285	BIP NIA MoP	165	16	29	128
30 Z303	BIP WbP GM	198	10	30	128



2022 **BIS**



2022 **WHP**



Z287 **G**



Z287 **WHP**



Z287 **BIP**



Z287 **Gr**

	Art. Nr / Art.-No.	Wykonanie / Finish	□	∅
31	2022	<b>BIS</b> <b>WHP</b>	22	32
32	Z287	<b>BIP</b> <b>WHP</b> <b>G</b> <b>Gr</b>	24	25





2786 **BIP**



2786 **WhP**



2786 **St**



2786 **BIP**



2786 **WhP**



2786 **G**



2786 **GM**



2786 **Gr**



2786 **MoP**



2786 **NIA**



2786 **MIA**

Art. Nr / Art.-No.	Wykonanie / Finish	□	∅
33 2786	St BIP WhP G GM Gr MoP NIA MIA	24	30
	BIP WhP	24	39



Z038 **BIP**



Z038 **MoP**



Z038 **BIP**



Z038 **MoP**



2991 **BIP**



2991 **WhP**



2324 **WhP**



2324 **BIP**

Art. Nr / Art.-No.	Wykonanie / Finish				
34 Z038	<b>BIP</b> <b>MoP</b>	30	30	18	
		38	38	21	
35 2991	<b>BIP</b> <b>WhP</b>	25	25	27	
36 2324	<b>BIP</b> <b>WhP</b>	40	40	27	16

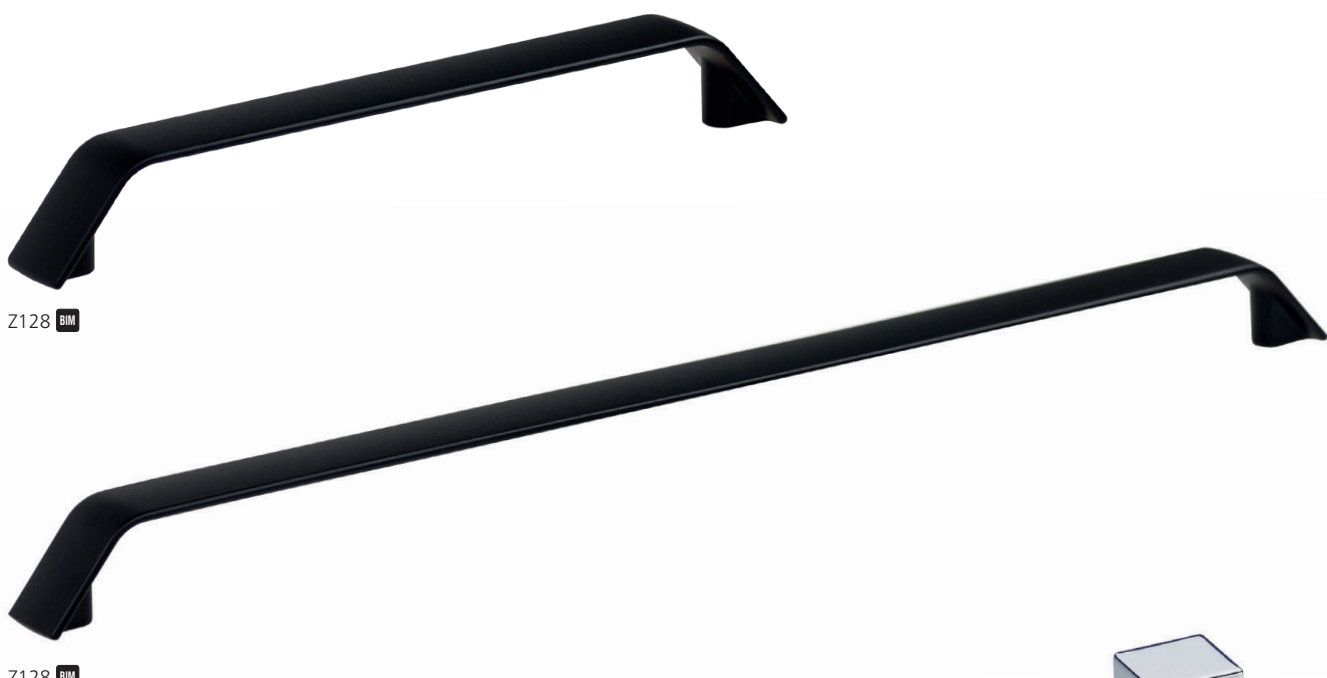

Z128 BIM

Z128 BIM



2810 GM







2810 WhP



2810 BIP



2810 Cr

Art. Nr / Art.-No.	Wykonanie / Finish				
37 Z128	BIM	181	20	24	160
		341	20	25	320
38 2810	Cr BIP WhP GM	20	20	23	



2267 MoP



2366 MoP



2267 NIA



2366 NIA



2267 BIP



2366 BIP

Art. Nr / Art.-No.	Wykonanie / Finish				+...+
39 2366		143	15	30	128
40 2267			15	25	





Z212 **BIP**



Z212 **NIA**



Z212 **MoP**



Z311 **WhP**



Z311 **BIP**



Z311 **NIA**

Art. Nr / Art.-No.	Wykonanie / Finish				
41 Z212	<b>BIP</b> <b>MoP</b> <b>NIA</b>	92	33	23	64
42 Z311	<b>BIP</b> <b>WhP</b> <b>NIA</b>	82,5	22,7	29	64



2232 **BIP**



2232 **BIP**



2232 **MoP**



2232 **MoP**

Art. Nr / Art.-No.	Wykonanie / Finish				
43 2232	<b>BIP</b> <b>MoP</b>	108	15	27	96
		140	15	29	128

Dla dzieci  
For children







K263 **F**



K263 **K**



K263 **B**



K263 **M**



**K** kotka / cat



**F** żaba / frog



**M** myszka / mouse



**B** miś / bear

Art. Nr / Art.-No.	Wykonanie / Finish				
44 K263	<b>K, F, M, B</b>	75	77	26	32



K074 **B**



K074 **P**



K074 **OT**



K074 **H**



Art. Nr / Art.-No.	Wykonanie / Finish			
45 K074	<b>P</b> <b>B</b> <b>OT</b> <b>H</b>	77	73	28





2810 Gr



2810 Ye



2810 Pi



2810 Bl



2810 Re



2786 Ye



2786 Gr



2786 Pi



2786 Bl



2786 Re

Art. Nr / Art.-No.	Wykonanie / Finish				
46 2810	<span>Ye</span> <span>Gr</span> <span>Pi</span> <span>Bl</span> <span>Re</span>	20	20	23	
47 2786				24	30



2342 Ye



2342 Gr



2342 Pi



2342 Bl



2342 Re



Z287 Ye



Z287 Gr



Z287 Pi



Z287 Bl



Z287 Re

	Art. Nr / Art.-No.	Wykonanie / Finish								
48	2342	<span style="background-color: yellow; border: 1px solid black; padding: 0 2px;">Ye</span>	<span style="background-color: green; border: 1px solid black; padding: 0 2px;">Gr</span>	<span style="background-color: pink; border: 1px solid black; padding: 0 2px;">Pi</span>	<span style="background-color: blue; border: 1px solid black; padding: 0 2px;">Bl</span>	<span style="background-color: red; border: 1px solid black; padding: 0 2px;">Re</span>	123	18	29	96
49	Z287							24	25	



2971 **Ye**



2576 **Ye**



2971 **Gr**



2576 **Gr**



2971 **Pi**



2576 **Pi**



2971 **Bl**



2576 **Bl**



2971 **Re**



2576 **Re**

Art. Nr / Art.-No.	Wykonanie / Finish				
50 2576	<b>Ye</b> <b>Gr</b> <b>Pi</b> <b>Bl</b> <b>Re</b>	113	8	27	96
51 2971		150	8	27	128
		16	23	9	45

# Specjalne Specials







2943 CrM

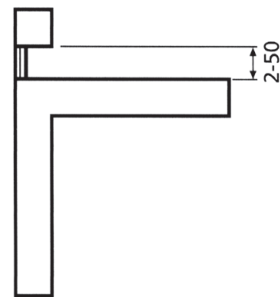
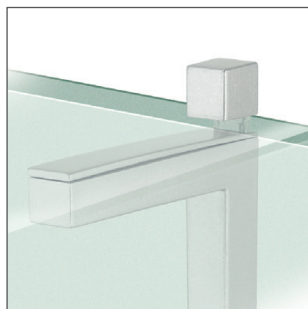

6796/6797 CrL



6796/6797 BIM



6796/6797 WhP

Art. Nr / Art.-No.	Rodzaj / Type	Materiał / Material	Wykonanie / Finish					
52 2943	wspornik / support		CrM Cr	64	100	18	118	
53 6796/6797	przepust kablowy / cable culvert		CrL BIM WhP	87	87	4/26	79/83	





2614 **BIM**



2617 **BIM**



2505 **BIP**



2571 **BIP**



K289 **CrM**

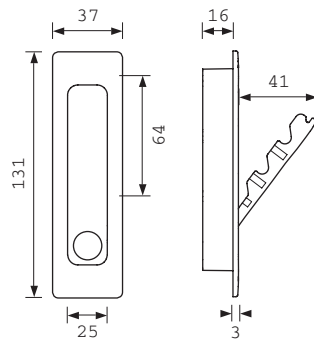

Z093 **Cr**

	Art. Nr / Art.-No.	Materiał / Material	Wykonanie / Finish				
54	2614		<b>BIM</b>	70	105	169	25
55	2617		<b>BIM</b>	70	42	82	25
56	2505		<b>BIP</b>	34	61	131	32
57	2571		<b>BIP</b>	34	61	132	32
58	K289		<b>CrM</b>	37	3/16	131	64
59	Z093		<b>CrM</b> <b>Cr</b>	65	47	73	20



Z278 **WHP**



Z278 **BIP**

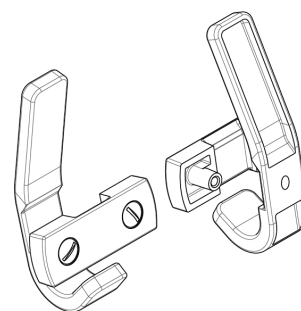

Z2971 **GM**



Z2971 **WHP**



Z2971 **BIP**



Z2971 **Cr**



Z069 **WHP**



Z069 **BIS**

Art. Nr / Art.-No.	Materiał / Material	Wykonanie / Finish				
60 Z278		<b>BIP</b> <b>WHP</b>	55	33/39	89	32
61 Z2971		<b>Cr</b> <b>BIP</b> <b>WHP</b> <b>GM</b>	9	23	45	16
62 Z069		<b>BIS</b> <b>WHP</b>	26	45	29	16



2316 **WhP**



2316 **BIP**



2345 **BIP**



2345 **WhP**



Z234 **WhP**



Z234 **BIP**

Art. Nr / Art.-No.	Materiał / Material	Wykonanie / Finish				+
63	2316	<b>CrM</b> <b>BIP</b> <b>WhP</b> <b>NiM</b>	16	70	123	32
64	2345	<b>BIP</b>	16	52	66	32
65	Z234	<b>BIP</b> <b>WhP</b>	74	53	103	16



2784 **BIS**







2784 **WhP**



2681 **WhP**



2681 **BIS**

Art. Nr / Art.-No.	Materiał / Material	Wykonanie / Finish				
66 2784		<b>BIS</b> <b>WhP</b>	68	82	175	32
67 2681			68	50	75	32



2071 **BIS**



2071 **WhP**



2083 **WhP**



2083 **BIS**

	Art. Nr / Art.-No.	Materiał / Material	Wykonanie / Finish				←...→
68	2071		<b>BIS</b> <b>WhP</b>	24	88	138	32
69	2083		<b>BIS</b> <b>WhP</b>	12	69	68	32





Z046 WhP



Z046 BIP



Z969 WhP













Z969 BIP



Z317 BIS



Z317 WhP

Art. Nr / Art.-No.	Materiał / Material	Wykonanie / Finish				
70	Z046	 	20	40	79	32
71	Z969	 	42	11	45	32
72	Z317	 	17	33	42	32



6435 **Cr**



6435 **BIM**



K042 **BIM**



K042 **CrL**



6601 **CrL**



6601 **BIM**

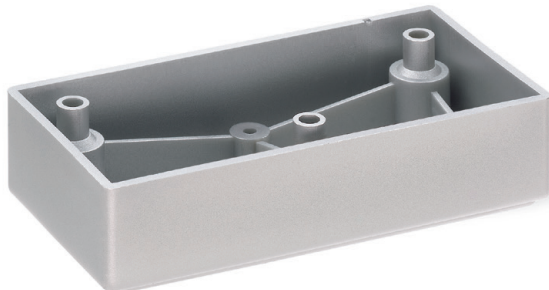

6838 **CrL**

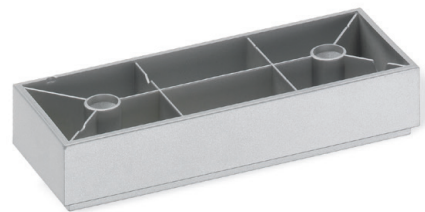

K160 **CrL**







Art. Nr / Art.-No.	Materiał / Material	Wykonanie / Finish				+...+
73 6435		<b>CrL</b> <b>Cr</b> <b>BIM</b>	60	60	25	32
74 K042			56	56	15	32/32
75 6601			56	56	20	2x32
76 K160		<b>CrL</b> <b>BIM</b>	100	40	20	64
77 6838			120	60	30	32/96



K440 



K441 

Art. Nr / Art.-No.	Materiał / Material	Wykonanie / Finish				
78 K440			78	70	120	40/50
79 K441			78	70	120	48/52

# Indeks / Index

Art. nr	
2022.....	26
2071.....	45
2083.....	45
2084.....	17
2225.....	18
2232.....	32
2267.....	30
2316.....	43
2324.....	28
2342.....	24, 37
2345.....	43
2366.....	30
2389.....	10
2505.....	41
2516.....	13
2571.....	41
2576.....	11
2576.....	38
2614.....	41
2617.....	41
2681.....	44
2784.....	44
2786.....	27, 36
2810.....	29, 36
2891.....	20
2930.....	21
2943.....	40
2969.....	46
2971.....	38, 42
2991.....	28
3748.....	7
3857.....	6
4394.....	8
6435.....	47
6601.....	47
6838.....	47
6796/6797.....	40

Art. nr	
K042.....	47
K074.....	35
K160.....	47
K263.....	34
K289.....	41
K440.....	48
K441.....	48
Z003.....	12
Z008.....	16
Z010.....	17
Z011.....	12
Z030.....	15
Z038.....	28
Z040.....	15
Z046.....	46
Z069.....	42
Z072.....	17
Z077.....	14
Z087.....	19
Z093.....	41
Z128.....	29
Z133.....	23
Z162.....	21
Z212.....	31
Z234.....	43
Z245.....	18
Z273.....	20
Z278.....	42
Z283.....	19
Z285.....	25
Z287.....	26, 37
Z299.....	23
Z303.....	25
Z306.....	22
Z311.....	31
Z317.....	46
Z324.....	15

## Wykończenie / Finish

<b>AA</b>	aluminium anodowane	anodized aluminium
<b>IN</b>	INOX	INOX
<b>CrM</b>	chrom mat	mat chrome
<b>CrL</b>	mat chrom lakier	mat chrome lacquered
<b>Cr</b>	chrom połysk	polished chrome
<b>St</b>	efekt stali nierdzewnej	stainless steel effect
<b>NIM</b>	nikiel mat	mat nickel
<b>NiB</b>	nikiel mat szczotkowany	brushed mat nickel
<b>MoP</b>	mosiądz patynowany	antique brass
<b>NIA</b>	nikiel antyczny	antique nickel
<b>MIA</b>	miedź antyczna	antique copper
<b>P</b>	różowy	pink
<b>B</b>	niebieski	blue
<b>OT</b>	pomarańcz przezroczysty	orange transparent
<b>H</b>	wrzosowy	heather
<b>BIM</b>	czarny mat lakier	mat black lacquered
<b>BIP</b>	czarny półmat lakier	semimat black lacquered
<b>BIS</b>	czarny struktura	structure black
<b>WhP</b>	biały półmat lakier	semimat white lacquered
<b>Bl</b>	niebieski lakier	blue lacquered
<b>Ye</b>	żółty lakier	yellow lacquered
<b>PI</b>	różowy lakier	pink lacquered
<b>Gr</b>	zielony lakier	green lacquered
<b>Re</b>	czerwony lakier	red lacquered
<b>Gr</b>	szary lakier	grey lacquered
<b>G</b>	grafit lakier	graphite lacquered
<b>GM</b>	grafit marone lakier	graphite marone lacquered

## Materiał / Material

	aluminium	aluminium
	metal	metal
	stal nierdzewna	stainless steel
	tworzywo	plastic
	akryl	acryl
	guma	rubber
	drewno	wood





**Schwinn Polska Sp. z o.o.**

ul. Nad Drwiną 4  
30-741 Kraków

Tel. +48 (12) 650 80 30

Tel. +48 (12) 653 06 35

Fax +48 (12) 653 50 18

E-Mail [schwinn@schwinn.com.pl](mailto:schwinn@schwinn.com.pl)

Internet [pl.schwinn-group.com](http://pl.schwinn-group.com)