



## Edelstahl – Trend



▶ MB 1.36



▶ MB 1.37



▶ MB 1.42



▶ MB 1.43



▶ MB 1.43



▶ MB 1.120



▶ MB 1.121

## Edelstahl – Zeitlos



▶ MB 1.132



▶ MB 1.132



▶ MB 1.133



▶ MB 1.133



▶ MB 1.133



▶ MB 1.146



▶ MB 1.147



▶ MB 1.147 **Topco**



▶ MB 1.147



▶ MB 1.147



▶ MB 1.148



▶ MB 1.148 **Topco**



▶ MB 1.149



▶ MB 1.149 **Topco**



▶ MB 1.150



▶ MB 1.150 **Topco**



▶ MB 1.151



▶ MB 1.151 **Topco**



▶ MB 1.152



▶ MB 1.152



▶ MB 1.153



▶ MB 1.153



▶ MB 1.154



▶ MB 1.154



▶ MB 1.155



▶ MB 1.156



▶ MB 1.157



▶ MB 1.57



▶ MB 1.158



▶ MB 1.158



▶ MB 1.158



▶ MB 1.158



▶ MB 1.159

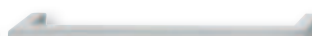

▶ MB 1.159



▶ MB 1.160



▶ MB 1.160



▶ MB 1.161



▶ MB 1.161



▶ MB 1.190



















▶ MB 1.191

DGH-M 2018, HDE-de, 06/18; Maßangaben unverbindlich. Konstruktionsänderungen vorbehalten.



Edelstahl – Zeitlos

					
▶ MB 1.191	▶ MB 1.191	▶ MB 1.192	▶ MB 1.192		
					
▶ MB 1.193 <b>Topco</b>	▶ MB 1.193 <b>Topco</b>	▶ MB 1.194	▶ MB 1.194		
					
▶ MB 1.194 <b>Topco</b>	▶ MB 1.194 <b>Topco</b>	▶ MB 1.195	▶ MB 1.196		
					
▶ MB 1.196	▶ MB 1.196 <b>Topco</b>	▶ MB 1.196 <b>Topco</b>	▶ MB 1.197		
					
▶ MB 1.197	▶ MB 1.197 <b>Topco</b>	▶ MB 1.197 <b>Topco</b>	▶ MB 1.198		
					
▶ MB 1.198 <b>Topco</b>	▶ MB 1.199	▶ MB 1.199 <b>Topco</b>	▶ MB 1.200		
					
▶ MB 1.201	▶ MB 1.201 <b>Topco</b>	▶ MB 1.201	▶ MB 1.202		
					
▶ MB 1.202 <b>Topco</b>	▶ MB 1.203	▶ MB 1.203 <b>Topco</b>	▶ MB 1.257		
					
▶ MB 1.257 <b>Topco</b>	▶ MB 1.257 <b>Topco</b>	▶ MB 1.263			
					
▶ MB 1.156 <b>Topco</b>	▶ MB 1.263	▶ MB 1.263	▶ MB 1.263	▶ MB 1.263	▶ MB 1.267
					
▶ MB 1.267	▶ MB 1.267	▶ MB 1.267	▶ MB 1.268	▶ MB 1.268	▶ MB 1.268
					
▶ MB 1.268	▶ MB 1.269	▶ MB 1.269	▶ MB 1.270	▶ MB 1.270	▶ MB 1.270
					
▶ MB 1.271	▶ MB 1.271	▶ MB 1.271	▶ MB 1.271		

DGH-M 2018; HDE-de, 06/18; Maßangaben unverbindlich. Konstruktionsänderungen vorbehalten.





## Aluminium – Trend

- |   |   |   |   |
|---|---|---|---|
|    |    |   |    |
| ▶ MB 1.37   | ▶ MB 1.77   | ▶ MB 1.77   | ▶ MB 1.77   |
|    |    |   |    |
| ▶ MB 1.77   | ▶ MB 1.78   | ▶ MB 1.78   | ▶ MB 1.79   |
|    |    |   |    |
| ▶ MB 1.79   | ▶ MB 1.104  | ▶ MB 1.104  | ▶ MB 1.107  |
|    |    |   |    |
| ▶ MB 1.107  | ▶ MB 1.108  | ▶ MB 1.108  | ▶ MB 1.108  |
|    |   |   |   |
| ▶ MB 1.79   | ▶ MB 1.79   |   |   |
|   |   |   |   |
| ▶ MB 1.79   | ▶ MB 1.79   | ▶ MB 1.107  | ▶ MB 1.107  |
|  |  |  |  |
| ▶ MB 1.122  | ▶ MB 1.122  | ▶ MB 1.122  | ▶ MB 1.122  |

## Aluminium – Zeitlos

- |   |   |  |   |
|---|---|--|---|
|  |  |  |  |
| ▶ MB 1.134  | ▶ MB 1.134  | ▶ MB 1.135   | ▶ MB 1.135  |
|  |  |  |  |
| ▶ MB 1.135  | ▶ MB 1.162  | ▶ MB 1.162   | ▶ MB 1.163  |
|  |  |  |  |
| ▶ MB 1.163  | ▶ MB 1.164  | ▶ MB 1.164   | ▶ MB 1.165  |
|  |  |  |  |
| ▶ MB 1.165  | ▶ MB 1.204  | ▶ MB 1.204   | ▶ MB 1.205  |
|  |  |  |  |
| ▶ MB 1.205  | ▶ MB 1.205  | ▶ MB 1.206 <b>Topco</b>  | ▶ MB 1.206  |

DGH-M 2018, HDE-de, 06/18; Maßangaben unverbindlich. Konstruktionsänderungen vorbehalten.



1

## Aluminium – Zeitlos

Möbelgriffe und -knöpfe, Aluminium



▶ MB 1.207

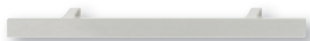

▶ MB 1.207



▶ MB 1.208



▶ MB 1.208



▶ MB 1.208



▶ MB 1.209



▶ MB 1.209



▶ MB 1.211



▶ MB 1.212



▶ MB 1.258



▶ MB 1.258



▶ MB 1.259



▶ MB 1.259 **Topco**



▶ MB 1.260

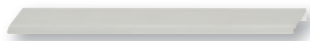

▶ MB 1.264



▶ MB 1.264

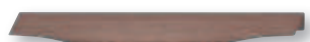

▶ MB 1.264



▶ MB 1.258



▶ MB 1.260



▶ MB 1.260



▶ MB 1.273



▶ MB 1.273



▶ MB 1.273



▶ MB 1.272



▶ MB 1.272



▶ MB 1.272



▶ MB 1.272



## Stahl – Trend



▶ MB 1.36



▶ MB 1.42



▶ MB 1.44



▶ MB 1.44



▶ MB 1.45



▶ MB 1.46



▶ MB 1.46



▶ MB 1.120



▶ MB 1.121

## Stahl – Zeitlos

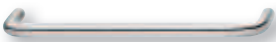

▶ MB 1.182

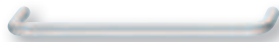

▶ MB 1.182

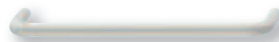

▶ MB 1.182



▶ MB 1.182

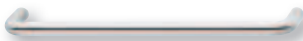

▶ MB 1.183

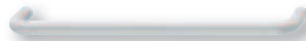

▶ MB 1.183



▶ MB 1.183

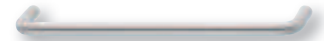

▶ MB 1.183



▶ MB 1.216



▶ MB 1.217



▶ MB 1.218



▶ MB 1.219



▶ MB 1.219



▶ MB 1.220



▶ MB 1.220



▶ MB 1.220



▶ MB 1.136



▶ MB 1.136



▶ MB 1.136



▶ MB 1.136



▶ MB 1.137



▶ MB 1.137



▶ MB 1.137



▶ MB 1.184



▶ MB 1.184



▶ MB 1.184



▶ MB 1.137

DGH-M 2018, HDE-de, 06/18; Maßangaben unverbindlich. Konstruktionsänderungen vorbehalten.



1

Messing – Zeitlos



▶ MB 1.166



▶ MB 1.166

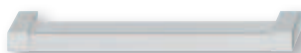

▶ MB 1.213



▶ MB 1.213



▶ MB 1.214



▶ MB 1.274



▶ MB 1.274



▶ MB 1.274



▶ MB 1.274



▶ MB 1.274



▶ MB 1.274



▶ MB 1.274



▶ MB 1.274



▶ MB 1.274



▶ MB 1.274



▶ MB 1.274



▶ MB 1.275



▶ MB 1.275



▶ MB 1.275



▶ MB 1.275



▶ MB 1.275



▶ MB 1.275



▶ MB 1.275



▶ MB 1.276



▶ MB 1.276



▶ MB 1.276

Möbelgriffe und -knöpfe, Messing

DGH-M 2018; HDE-de, 06/18; Maßangaben unverbindlich. Konstruktionsänderungen vorbehalten.



Messing – Traditionell



▶ MB 1.337



▶ MB 1.337



▶ MB 1.339



▶ MB 1.335



▶ MB 1.335



▶ MB 1.337



▶ MB 1.339



▶ MB 1.345



▶ MB 1.345



▶ MB 1.345



▶ MB 1.334

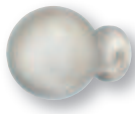

▶ MB 1.334

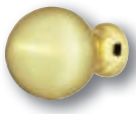

▶ MB 1.334



▶ MB 1.334



▶ MB 1.334



▶ MB 1.334



▶ MB 1.343



▶ MB 1.343



▶ MB 1.343



▶ MB 1.343



▶ MB 1.343



▶ MB 1.343

DGH-M 2018, HIDE-de, 06/18; Maßangaben unverbindlich. Konstruktionsänderungen vorbehalten.

Möbelgriffe und -knöpfe, Messing



1

Zinkdruckguss – Trend

Möbelgriffe und -knöpfe, Zinkdruckguss



DGH-M 2018; HDE-de, 06/18; Maßangaben unverbindlich. Konstruktionsänderungen vorbehalten.





			
▶ MB 1.57	▶ MB 1.57	▶ MB 1.58	▶ MB 1.58
			
▶ MB 1.58	▶ MB 1.58	▶ MB 1.58	▶ MB 1.59
			
▶ MB 1.59	▶ MB 1.59	▶ MB 1.59	▶ MB 1.59
			
▶ MB 1.59	▶ MB 1.60	▶ MB 1.60	▶ MB 1.60
			
▶ MB 1.60	▶ MB 1.61	▶ MB 1.61	▶ MB 1.62
			
▶ MB 1.162	▶ MB 1.62	▶ MB 1.62	▶ MB 1.63
			
▶ MB 1.63	▶ MB 1.63	▶ MB 1.64	▶ MB 1.64
			
▶ MB 1.64	▶ MB 1.65	▶ MB 1.65	▶ MB 1.66
			
▶ MB 1.66	▶ MB 1.66	▶ MB 1.67	▶ MB 1.67
			
▶ MB 1.67	▶ MB 1.68	▶ MB 1.68	▶ MB 1.69
			
▶ MB 1.69	▶ MB 1.69	▶ MB 1.69	▶ MB 1.70
			
▶ MB 1.70	▶ MB 1.70	▶ MB 1.71	▶ MB 1.71

DGH-M 2018, HDE-de, 06/18; Maßangaben unverbindlich. Konstruktionsänderungen vorbehalten.

Möbelgriffe und -knöpfe, Zinkdruckguss



Zinkdruckguss – Trend



▶ MB 1.71



▶ MB 1.72



▶ MB 1.72



▶ MB 1.72



▶ MB 1.37



▶ MB 1.73



▶ MB 1.73



▶ MB 1.80



▶ MB 1.80



▶ MB 1.80



▶ MB 1.80



▶ MB 1.81



▶ MB 1.81



▶ MB 1.81



▶ MB 1.82



▶ MB 1.82



▶ MB 1.83



▶ MB 1.83



▶ MB 1.83



▶ MB 1.83

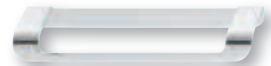

▶ MB 1.105



▶ MB 1.106



▶ MB 1.109



▶ MB 1.109



▶ MB 1.110



▶ MB 1.110



▶ MB 1.111



▶ MB 1.111

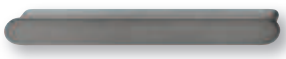

▶ MB 1.112



▶ MB 1.112

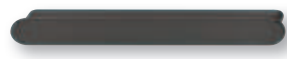

▶ MB 1.112



▶ MB 1.112



▶ MB 1.113



▶ MB 1.113



▶ MB 1.114



▶ MB 1.114



▶ MB 1.114



▶ MB 1.115



▶ MB 1.115



▶ MB 1.115



▶ MB 1.115



▶ MB 1.115



▶ MB 1.115



Zinkdruckguss – Trend



Zinkdruckguss – Zeitlos



DGH-M 2018, HDE-de, 06/18; Maßangaben unverbindlich. Konstruktionsänderungen vorbehalten.



1

Möbelgriffe und -knöpfe, Zinkdruckguss

## Zinkdruckguss – Zeitlos



▶ MB 1.142



▶ MB 1.143



▶ MB 1.143



▶ MB 1.143



▶ MB 1.144



▶ MB 1.144



▶ MB 1.144



▶ MB 1.144



▶ MB 1.145



▶ MB 1.145



▶ MB 1.167



▶ MB 1.167



▶ MB 1.168

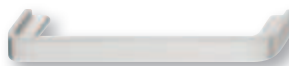

▶ MB 1.168

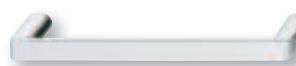

▶ MB 1.169

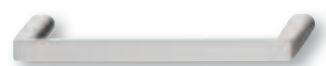

▶ MB 1.169



▶ MB 1.170



▶ MB 1.170



▶ MB 1.171



▶ MB 1.171



▶ MB 1.172



▶ MB 1.172



▶ MB 1.173



▶ MB 1.173

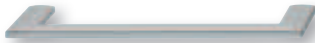

▶ MB 1.174



▶ MB 1.174

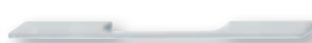

▶ MB 1.174



▶ MB 1.174



▶ MB 1.175



▶ MB 1.175



▶ MB 1.176

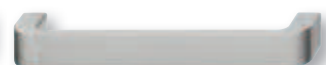

▶ MB 1.176



▶ MB 1.176



▶ MB 1.176



▶ MB 1.177



▶ MB 1.177



▶ MB 1.178



▶ MB 1.178



▶ MB 1.178



▶ MB 1.179



▶ MB 1.179



▶ MB 1.179



▶ MB 1.180



▶ MB 1.180



▶ MB 1.181



▶ MB 1.181



▶ MB 1.181



▶ MB 1.181

DGH-M 2018; HDE-de, 06/18; Maßangaben unverbindlich. Konstruktionsänderungen vorbehalten.



Zinkdruckguss – Zeitlos



DGH-M 2018, HDE-de, 06/18; Maßangaben unverbindlich. Konstruktionsänderungen vorbehalten.





## Zinkdruckguss – Traditionell



▶ MB 1.333



▶ MB 1.334



▶ MB 1.334



▶ MB 1.334



▶ MB 1.336



▶ MB 1.336

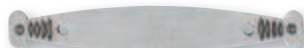

▶ MB 1.336



▶ MB 1.336



▶ MB 1.340



▶ MB 1.341



▶ MB 1.342



▶ MB 1.342



▶ MB 1.342



▶ MB 1.349



▶ MB 1.340



▶ MB 1.341



▶ MB 1.341



▶ MB 1.346



▶ MB 1.347



▶ MB 1.347



▶ MB 1.347



▶ MB 1.347



▶ MB 1.348



▶ MB 1.348



▶ MB 1.348



▶ MB 1.348



▶ MB 1.348



▶ MB 1.348



▶ MB 1.348



▶ MB 1.348



▶ MB 1.348



▶ MB 1.349

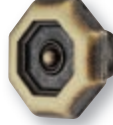

▶ MB 1.349



▶ MB 1.350



▶ MB 1.350

## Zinkdruckguss – Luxuriös



▶ MB 1.357



▶ MB 1.357



▶ MB 1.358



▶ MB 1.358



▶ MB 1.359



▶ MB 1.359





## Holz, Holz-Metall – Trend



▶ MB 1.40



▶ MB 1.40



▶ MB 1.40



▶ MB 1.40



▶ MB 1.40



▶ MB 1.40



▶ MB 1.74



▶ MB 1.74



▶ MB 1.74



▶ MB 1.75



▶ MB 1.75



▶ MB 1.126



▶ MB 1.126



▶ MB 1.126



▶ MB 1.127



▶ MB 1.127



▶ MB 1.127

## Holz, Holz-Metall – Zeitlos



▶ MB 1.221



▶ MB 1.221



▶ MB 1.221



▶ MB 1.222



▶ MB 1.222



▶ MB 1.222



▶ MB 1.185



▶ MB 1.185



▶ MB 1.185



▶ MB 1.283



▶ MB 1.283



▶ MB 1.283



▶ MB 1.283



▶ MB 1.283



▶ MB 1.283

DGH-M 2018, HIDE-de, 06/18; Maßangaben unverbindlich. Konstruktionsänderungen vorbehalten.



1

Möbelgriffe und -knöpfe, Kunststoff, Kunststoff-Metall, Glas

Kunststoff, Kunststoff-Metall – Trend



▶ MB 1.76



▶ MB 1.128



▶ MB 1.128

Kunststoff, Kunststoff-Metall – Zeitlos



▶ MB 1.188



▶ MB 1.188



▶ MB 1.186



▶ MB 1.186



▶ MB 1.186



▶ MB 1.187



▶ MB 1.284



▶ MB 1.284



▶ MB 1.285



▶ MB 1.285



▶ MB 1.284



▶ MB 1.284



▶ MB 1.285

Glas – Zeitlos



▶ MB 1.189



▶ MB 1.223

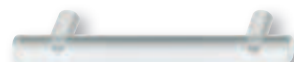

▶ MB 1.223



▶ MB 1.286



▶ MB 1.286



▶ MB 1.286

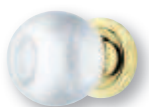

▶ MB 1.286



▶ MB 1.286



▶ MB 1.287

DGH-M 2018; HDE-de, 06/18; Maßangaben unverbindlich. Konstruktionsänderungen vorbehalten.



Leder, Leder-Metall – Trend



▶ MB 1.41



▶ MB 1.76



▶ MB 1.83

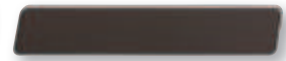

▶ MB 1.118



▶ MB 1.41



▶ MB 1.118



▶ MB 1.118



▶ MB 1.129



▶ MB 1.118



▶ MB 1.128



▶ MB 1.129



▶ MB 1.129



▶ MB 1.130



▶ MB 1.41



▶ MB 1.130



▶ MB 1.130

Porzellan – Traditionell



▶ MB 1.338



▶ MB 1.338



▶ MB 1.338



▶ MB 1.351



▶ MB 1.351



▶ MB 1.352



▶ MB 1.352



▶ MB 1.352



▶ MB 1.352

DGH-M 2018, HIDE-de, 06/18; Maßangaben unverbindlich. Konstruktionsänderungen vorbehalten.



## Aluminium – Zeitlos

1



▶ MB 1.288



▶ MB 1.290



▶ MB 1.290



▶ MB 1.290



▶ MB 1.290



▶ MB 1.292



▶ MB 1.292



▶ MB 1.292



▶ MB 1.292



▶ MB 1.292



▶ MB 1.292



▶ MB 1.292



▶ MB 1.292



▶ MB 1.296



▶ MB 1.296



▶ MB 1.296



▶ MB 1.296



▶ MB 1.294



▶ MB 1.294



▶ MB 1.294



▶ MB 1.294



▶ MB 1.295



▶ MB 1.295



▶ MB 1.295



▶ MB 1.295



▶ MB 1.295



▶ MB 1.295



▶ MB 1.295



▶ MB 1.295

Griff-Profilleisten, Aluminium

DGH-M 2018; HDE-de, 06/18; Maßangaben unverbindlich. Konstruktionsänderungen vorbehalten.



Aluminium – Zeitlos

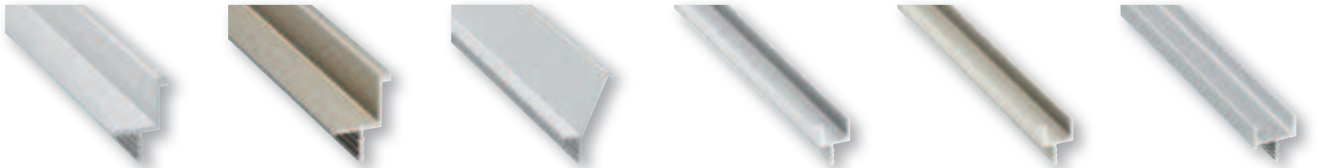

▶ MB 1.297    ▶ MB 1.297    ▶ MB 1.297    ▶ MB 1.298    ▶ MB 1.298    ▶ MB 1.298

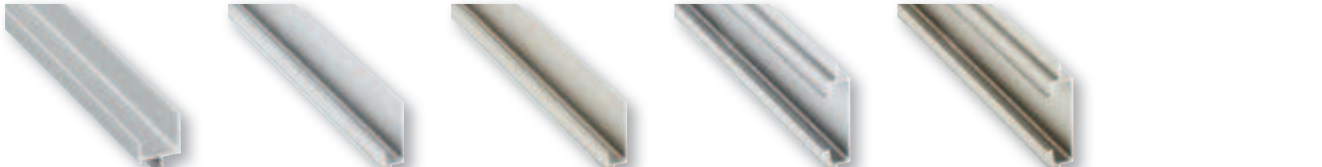

▶ MB 1.298    ▶ MB 1.299    ▶ MB 1.299    ▶ MB 1.300    ▶ MB 1.300

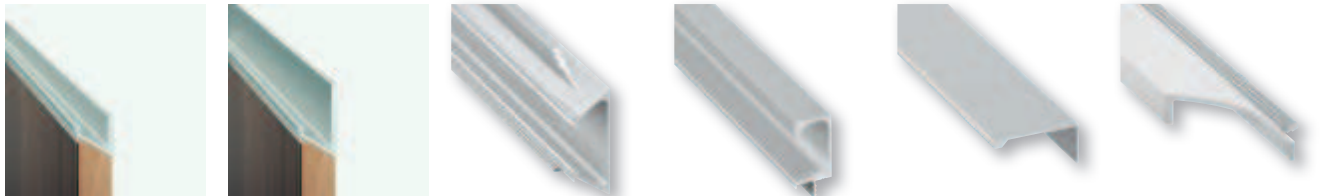

▶ MB 1.301    ▶ MB 1.301    ▶ MB 1.302    ▶ MB 1.302    ▶ MB 1.302    ▶ MB 1.303 **Topco**

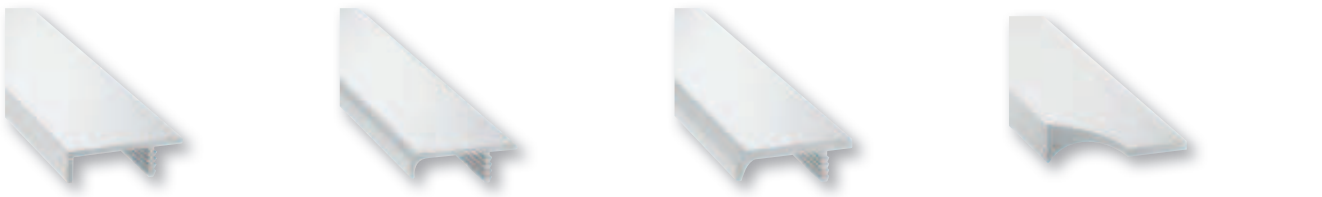

▶ MB 1.304 **Topco**    ▶ MB 1.305 **Topco**    ▶ MB 1.306 **Topco**    ▶ MB 1.307 **Topco**



▶ MB 1.308    ▶ MB 1.309    ▶ MB 1.310

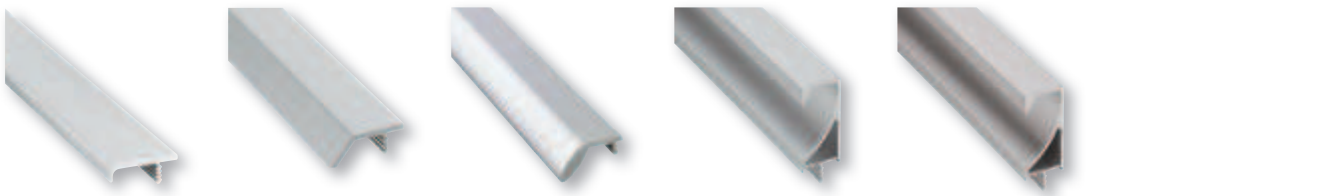

▶ MB 1.311    ▶ MB 1.311    ▶ MB 1.311    ▶ MB 1.312    ▶ MB 1.312



▶ MB 1.313    ▶ MB 1.313    ▶ MB 1.314    ▶ MB 1.315    ▶ MB 1.315    ▶ MB 1.315

DGH-M 2018, HDE-de, 06/18; Maßangaben unverbindlich. Konstruktionsänderungen vorbehalten.



1

## Edelstahl – Zeitlos



▶ MB 1.229



▶ MB 1.229



▶ MB 1.229



▶ MB 1.225



▶ MB 1.225



▶ MB 1.230



▶ MB 1.230



▶ MB 1.226



▶ MB 1.226



▶ MB 1.226



▶ MB 1.227



▶ MB 1.227



▶ MB 1.228



▶ MB 1.231



▶ MB 1.231



▶ MB 1.232



▶ MB 1.232



▶ MB 1.224



▶ MB 1.224



▶ MB 1.224

Muschelgriffe

## Aluminium – Trend



▶ MB 1.84

## Aluminium – Zeitlos



▶ MB 1.233



▶ MB 1.234



▶ MB 1.235



▶ MB 1.236

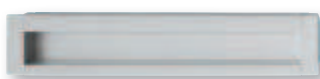

▶ MB 1.237



▶ MB 1.237



▶ MB 1.238



▶ MB 1.238



▶ MB 1.238

DGH-M 2018; HDE-de, 06/18; Maßangaben unverbindlich. Konstruktionsänderungen vorbehalten.





Stahl – Zeitlos

Stahl – Traditionell



▶ MB 1.239



▶ MB 1.239



▶ MB 1.239



▶ MB 1.350

Messing – Trend

Messing – Zeitlos



▶ MB 1.102



▶ MB 1.241



▶ MB 1.241



▶ MB 1.241



▶ MB 1.240



▶ MB 1.240



▶ MB 1.240



▶ MB 1.240

Zinkdruckguss – Trend



▶ MB 1.98



▶ MB 1.85



▶ MB 1.85



▶ MB 1.86



▶ MB 1.87



▶ MB 1.90



▶ MB 1.91



▶ MB 1.94



▶ MB 1.94



▶ MB 1.97



▶ MB 1.102



▶ MB 1.102



▶ MB 1.88



▶ MB 1.88



▶ MB 1.89



▶ MB 1.99



▶ MB 1.99

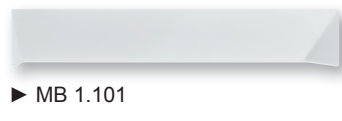

▶ MB 1.101

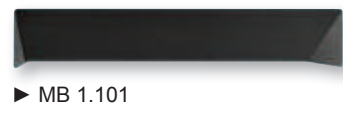

▶ MB 1.101



▶ MB 1.97



▶ MB 1.100



▶ MB 1.100

DGH-M 2018, HDE-de, 06/18; Maßangaben unverbindlich. Konstruktionsänderungen vorbehalten.



1

## Zinkdruckguss – Trend

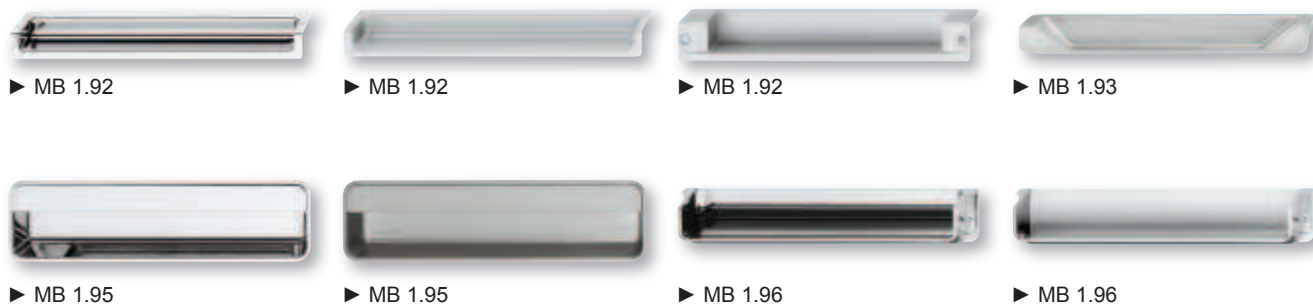

Muschelgriffe

## Zinkdruckguss – Zeitlos



DGH-M 2018; HDE-de, 06/18; Maßangaben unverbindlich. Konstruktionsänderungen vorbehalten.



Holz – Trend



▶ MB 1.103



▶ MB 1.103

Holz – Zeitlos



▶ MB 1.251



▶ MB 1.251



▶ MB 1.251

Kunststoff – Zeitlos



▶ MB 1.252



▶ MB 1.254



▶ MB 1.252



▶ MB 1.252



▶ MB 1.252



▶ MB 1.255



▶ MB 1.255



▶ MB 1.252



▶ MB 1.252



▶ MB 1.253



▶ MB 1.256



▶ MB 1.253



▶ MB 1.253



▶ MB 1.253



▶ MB 1.254



▶ MB 1.254

DGH-M 2018, HDE-de, 06/18; Maßangaben unverbindlich. Konstruktionsänderungen vorbehalten.



1

Griffe für Faltschiebetüren/Glastüren

### Griffe und Adapter für Faltschiebetüren Aluminium – Zeitlos



▶ MB 1.316

### Zinkdruckguss – Zeitlos



▶ MB 1.317



▶ MB 1.317



▶ MB 1.318



▶ MB 1.318

### Griffe für Glastüren Zinkdruckguss – Zeitlos



▶ MB 1.322



▶ MB 1.322



▶ MB 1.322

### Edelstahl – Zeitlos



▶ MB 1.319



▶ MB 1.319

### Aluminium – Zeitlos



▶ MB 1.320

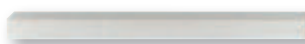

▶ MB 1.320

### Messing – Zeitlos



▶ MB 1.321



▶ MB 1.321



▶ MB 1.321

DGH-M 2018; HDE-de, 06/18; Maßangaben unverbindlich. Konstruktionsänderungen vorbehalten.



**Bootslook-Beschläge – Messing – Zeitlos**



**Beschriftungsrahmen – Metall/Kunststoff – Zeitlos**

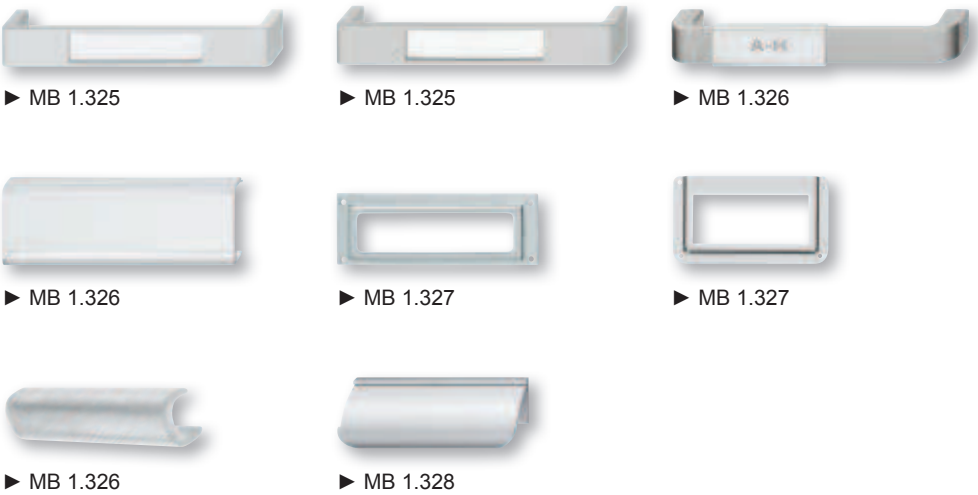

**Beschriftungsrahmen – Metall – Traditionell**



**Applikationen – Edelstahl/Zinkdruckguss – Zeitlos**



DGH-M 2018, HDE-de, 06/18; Maßangaben unverbindlich. Konstruktionsänderungen vorbehalten.



1

Schlüsselbuchsen und -schilder – Metall – Zeitlos



▶ MB 1.331



▶ MB 1.331

Schlüsselbuchsen und -schilder – Metall – Traditionell



▶ MB 1.354



▶ MB 1.354



▶ MB 1.354



▶ MB 1.354



▶ MB 1.355



▶ MB 1.354



▶ MB 1.354



▶ MB 1.355



▶ MB 1.355



▶ MB 1.354



▶ MB 1.354

Bootslook-Beschläge, Beschriftungsrahmen, Applikationen, Schlüsselschilder

DGH-M 2018; HDE-de, 06/18; Maßangaben unverbindlich. Konstruktionsänderungen vorbehalten.



# 1

# HÄFELE

## TREND.

ANGESAGTE HIGHLIGHTS UND MODERNE AKZENTE.



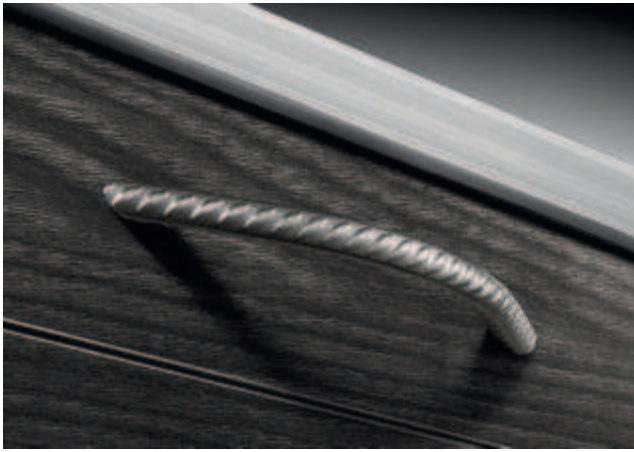

Bei diesen Griffen wurden bewusst Gebrauchsspuren eingearbeitet. Dadurch ist jeder Griff ein Unikat.

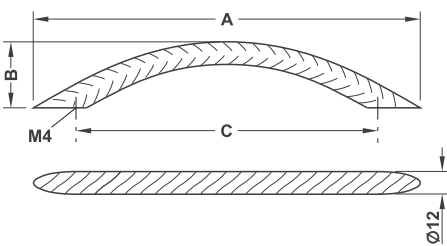

- > Werkstoff: Edelstahl Güte 1.4571
- > Oberfläche: matt gebürstet
- > Ausführung: Baustahl-Optik

Maß A mm	Maß B mm	Maß C mm	Artikel-Nr.
157,5	35	128	117.64.005
205,5	35	160	117.64.006
245,5	35	192	117.64.007

Abpackung: 1 oder 10 Stück

Möbelknopf Edelstahl in Baustahl-Optik	► MB 1.120
Bügelgriff Edelstahl in Baustahl-Optik	► MB 1.42
Garderobenhaken Edelstahl in Baustahl-Optik	► MB 1.411
Garderobenbügel Edelstahl in Baustahl-Optik	► MB 1.368

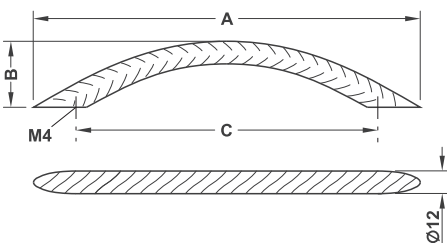

- > Werkstoff: Stahl
- > Oberfläche: roh lackiert, Used Look
- > Ausführung: Baustahl-Optik

Maß A mm	Maß B mm	Maß C mm	Artikel-Nr.
157,5	35	128	117.30.305
205,5	35	160	117.30.306
245,5	35	192	117.30.307

Abpackung: 1 oder 10 Stück

Möbelknopf Stahl in Baustahl-Optik	► MB 1.120
Bügelgriff Stahl in Baustahl-Optik	► MB 1.42
Garderobenhaken Stahl in Baustahl-Optik	► MB 1.411
Garderobenbügel Stahl in Baustahl-Optik	► MB 1.368

Gewindeschrauben M4	► MB 1.470
---------------------	------------

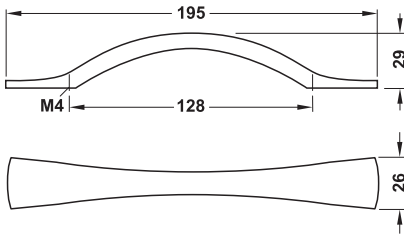

> Werkstoff: Edelstahl, Güte 1.4305

Oberfläche	Artikel-Nr.
matt gebürstet	105.74.002

Abpackung: 1 oder 50 Stück

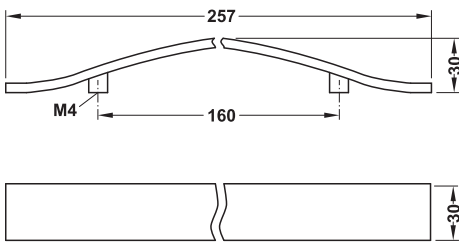

> Werkstoff: Aluminium

Oberfläche	Artikel-Nr.
edelstahlfarben	108.89.003

Abpackung: 1 oder 25 Stück

DGH-M 2018, HIDE-de, 06/18; Maßangaben unverbindlich. Konstruktionsänderungen vorbehalten.

Gewindeschrauben M4

► MB 1.470

1



Möbelgriffe Trend

Modell H1325

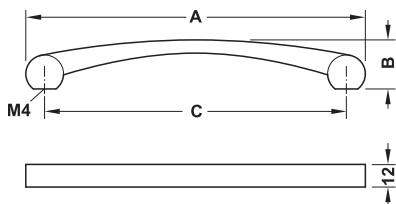
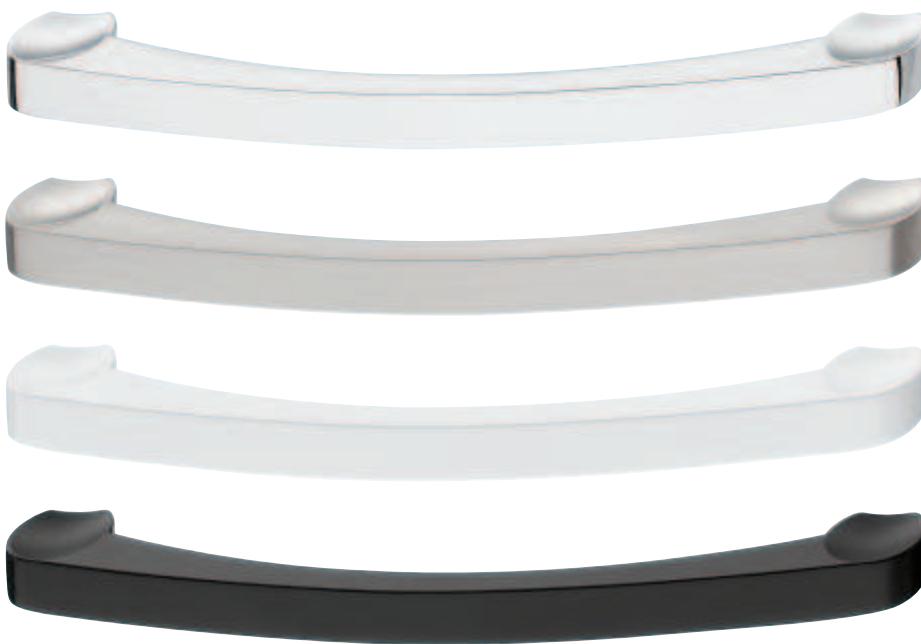

Oberfläche/Farbe	Maß A mm	Maß B mm	Maß C mm	Artikel-Nr.
verchromt poliert	180	28	160	110.34.286
	211	28	192	110.34.287
vernickelt gebürstet	180	28	160	110.34.686
	211	28	192	110.34.687
weiß, RAL 9016, matt, lackiert	180	28	160	110.34.786
	211	28	192	110.34.787
schwarz, RAL 9017, matt, lackiert	180	28	160	110.34.386
	211	28	192	110.34.387

Abpackung: 1 oder 10 Stück

Gewindeschrauben M4

► MB 1.470

DGH-M 2018; HDE-de, 06/18; Maßangaben unverbindlich. Konstruktionsänderungen vorbehalten.



Modell H1330



1  
GAEB  
CAD  
Möbelgriffe Trend

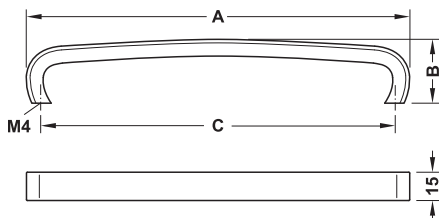

Oberfläche	Maß A mm	Maß B mm	Maß C mm	Artikel-Nr.
verchromt poliert	172	34	160	106.69.276
	204	34	192	106.69.277
vernickelt gebürstet	172	34	160	106.69.676
	204	34	192	106.69.677

Abpackung: 1 oder 25 Stück

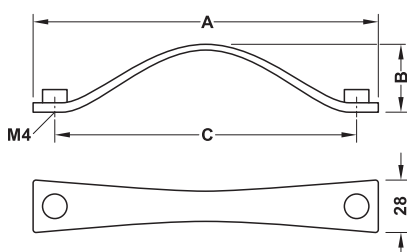

Oberfläche/Farbe	Maß A mm	Maß B mm	Maß C mm	Artikel-Nr.
schwarz matt used look	183	36	160	111.77.620

Abpackung: 1 oder 25 Stück

Gewindeschrauben M4

► MB 1.470

DGH-M 2018, HDE-de, 06/18; Maßangaben unverbindlich. Konstruktionsänderungen vorbehalten.

1



Möbelgriffe Trend

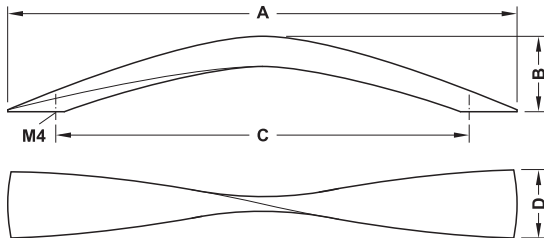

> Oberfläche: natur

Werkstoff	Maß A mm	Maß B mm	Maß C mm	Maß D mm	Artikel-Nr.
Nussbaum	80	32	64	34	193.19.703
	270	40	224	34	193.43.728
	388	40	320	36	193.43.729
Eiche	80	32	64	34	193.19.403
	270	40	224	34	193.43.428
	388	40	320	36	193.43.429

Abpackung: 1 oder 25 Stück

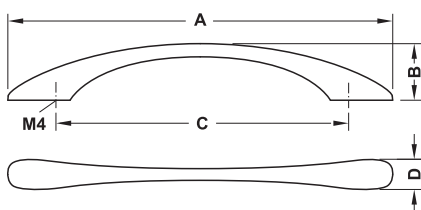

> Oberfläche: natur

Werkstoff	Maß A mm	Maß B mm	Maß C mm	Maß D mm	Artikel-Nr.
Nussbaum	204	32	160	16	193.43.756
Eiche	204	32	160	16	193.43.456

Abpackung: 1 oder 25 Stück

Gewindeschrauben M4

► MB 1.470

DGH-M 2018; HDE-de, 06/18; Maßangaben unverbindlich. Konstruktionsänderungen vorbehalten.

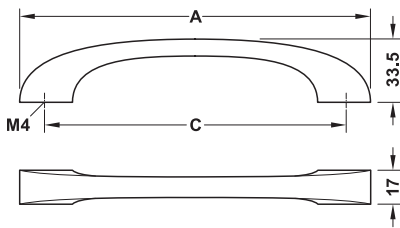

- > Werkstoff: Eiche
- > Oberfläche: natur geschliffen

Maß A mm	Maß C mm	Artikel-Nr.
186	160	191.67.010
250	224	191.67.020

Abpackung: 1 oder 25 Stück

DGH-M 2018, HIDE-de, 06/18; Maßangaben unverbindlich. Konstruktionsänderungen vorbehalten.

Gewindeschrauben M4

► MB 1.470

Möbelgriffe Trend



**DIESE SEITE WURDE BEWUSST  
LEER GELASSEN**

**INTENTIONAL BLANK PAGE**

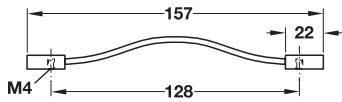

> Werkstoff: Griff: Leder,  
Sockel: Zinkdruckguss

Farbe	Artikel-Nr.
Griff: dunkelbraun Sockel: edelstahlfarben	110.79.012

Abpackung: 1 oder 10 Stück

passender Möbelknopf ▶ MB 1.129

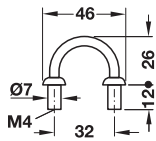

> Werkstoff: Griff: Leder,  
Sockel: Zinkdruckguss

Oberfläche/Farbe	Artikel-Nr.
Griff: hellbraun, Sockel: silberfarben	105.97.190

Abpackung: 1 oder 25 Stück

passender Möbelknopf ▶ MB 1.130

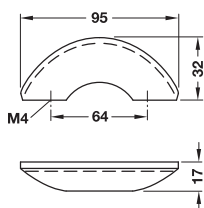

> Werkstoff: Leder

Farbe	Artikel-Nr.
dunkelbraun	109.64.130

Abpackung: 1 oder 10 Stück

Gewindeschrauben M4 ▶ MB 1.470

DGH-M 2018, HIDE-de, 06/18; Maßangaben unverbindlich. Konstruktionsänderungen vorbehalten.

1



Möbelgriffe Trend

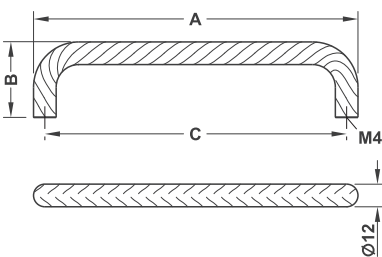
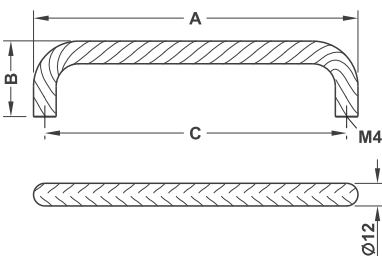

- > Werkstoff: Edelstahl, Güte 1.4571
- > Oberfläche: matt gebürstet
- > Ausführung: Baustahl-Optik

Maß A mm	Maß B mm	Maß C mm	Artikel-Nr.
140,5	40	128	117.64.015
172,5	40	160	117.64.016
204,5	40	192	117.64.017

Abpackung: 1 oder 10 Stück

Möbelknopf Edelstahl in Baustahl-Optik	► MB 1.120
Bogengriff Edelstahl in Baustahl-Optik	► MB 1.36
Garderobenbügel Edelstahl in Baustahl-Optik	► MB 1.368
Garderobenhaken Edelstahl in Baustahl-Optik	► MB 1.411

- > Werkstoff: Stahl
- > Oberfläche: roh lackiert, Used Look
- > Ausführung: in Baustahl-Optik

Maß A mm	Maß B mm	Maß C mm	Artikel-Nr.
140,5	40	128	117.30.315
172,5	40	160	117.30.316
204,5	40	192	117.30.317

Abpackung: 1 oder 10 Stück

Möbelknopf Stahl in Baustahl-Optik	► MB 1.120
Bogengriff Stahl in Baustahl-Optik	► MB 1.36
Garderobenbügel Stahl in Baustahl-Optik	► MB 1.368
Garderobenhaken Stahl in Baustahl-Optik	► MB 1.411

Gewindeschrauben M4

► MB 1.470

DGH-M 2018; HDE-de, 06/18; Maßangaben unverbindlich. Konstruktionsänderungen vorbehalten.

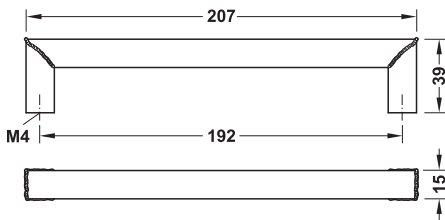

> Werkstoff: Edelstahl, Güte 1.4372  
> Ausführung: auf Gehrung geschweißt

Oberfläche	Artikel-Nr.
matt, Used Look	100.45.027

Abpackung: 1 oder 10 Stück

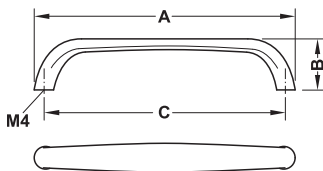

> Werkstoff: Edelstahl, Güte 1.4305  
> Oberfläche: matt gebürstet

Maß A mm	Maß B mm	Maß C mm	Artikel-Nr.
106	23	96	112.49.001
138	23	128	112.49.002
172	28	160	112.49.003
204	28	192	112.49.004

Abpackung: 1 oder 10 Stück

Gewindeschrauben M4

► MB 1.470

DGH-M 2018, HIDE-de, 06/18; Maßangaben unverbindlich. Konstruktionsänderungen vorbehalten.

1



Möbelgriffe Trend

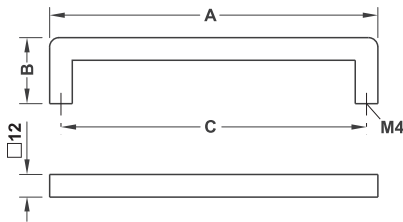
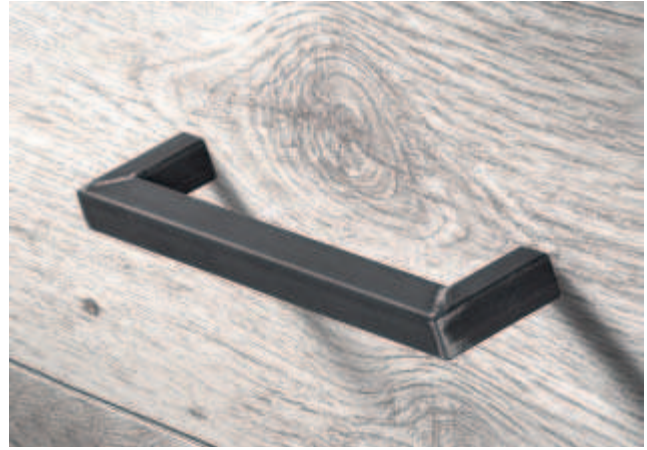
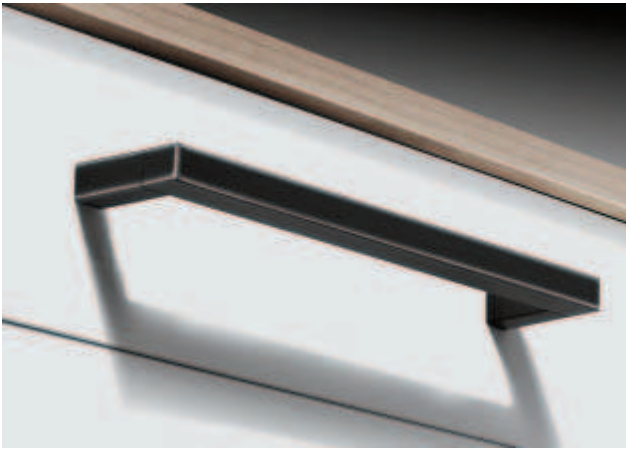

> Oberfläche/Farbe: schwarz gebürstet, Used Look

Maß A mm	Maß B mm	Maß C mm	Artikel-Nr.
140	35	128	113.50.305
172	35	160	113.50.306
204	35	192	113.50.307

Abpackung: 1 oder 10 Stück

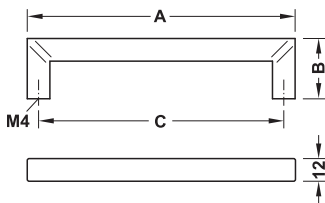

> Oberfläche: matt lackiert, Used Look

Maß A mm	Maß B mm	Maß C mm	Artikel-Nr.
140	32	128	110.65.315
204	32	192	110.65.317

Abpackung: 1 oder 10 Stück

passender Knopf ▶ MB 1.121

passender Garderobenhaken ▶ MB 1.435

Gewindeschrauben M4 ▶ MB 1.470

DGH-M 2018; HDE-de, 06/18; Maßangaben unverbindlich. Konstruktionsänderungen vorbehalten.



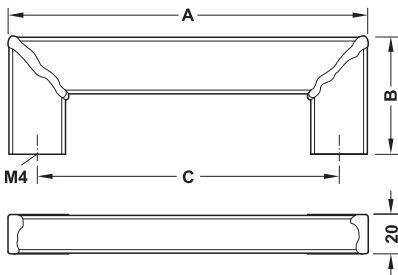

> Oberfläche/Farbe: schwarz lackiert, Used Look  
 > Ausführung: auf Gehrung geschweißt

Maß A mm	Maß B mm	Maß C mm	Artikel-Nr.
190	60	160	100.45.306
350	60	320	100.45.309

Abpackung: 1 oder 10 Stück

DGH-M 2018, HIDE-de, 06/18; Maßangaben unverbindlich. Konstruktionsänderungen vorbehalten.

Gewindeschrauben M4

► MB 1.470

1



Möbelgriffe Trend

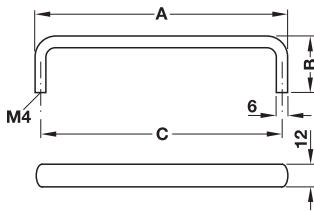

Oberfläche	Maß A mm	Maß B mm	Maß C mm	Artikel-Nr.
verkupfert gebürstet	134	30	128	117.64.105
verkupfert durchgerieben, Used Look	134	30	128	117.64.115

Abpackung: 1 oder 10 Stück

passende Möbelknöpfe ▶ MB 1.345

Gewindeschrauben M4 ▶ MB 1.470

DGH-M 2018; HDE-de, 06/18; Maßangaben unverbindlich. Konstruktionsänderungen vorbehalten.



Häfele Design Modell H1935



Knoten an den Griffenden passend zu den Eckknoten des Aluminium-Regalsystems.



1

Möbelgriffe Trend

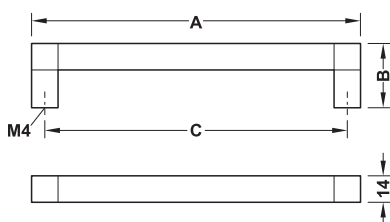
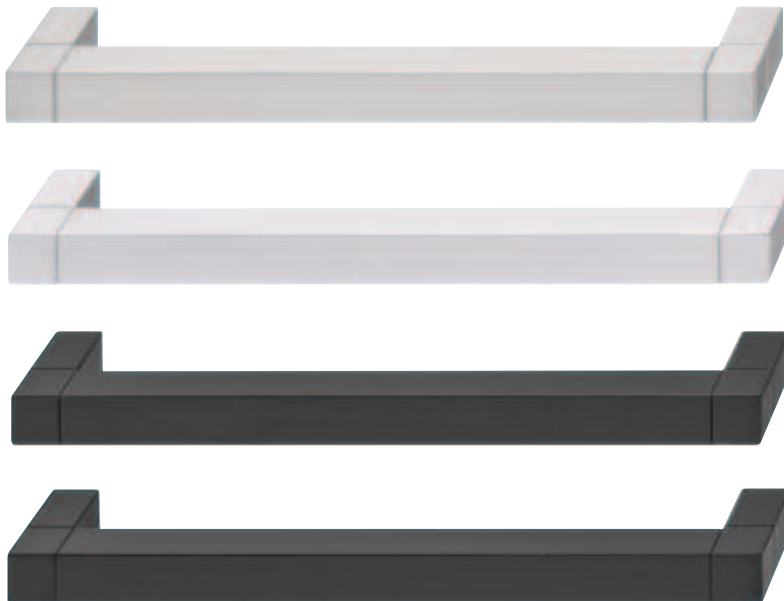

Oberfläche/Farbe	Maß A mm	Maß B mm	Maß C mm	Artikel-Nr.
vernickelt gebürstet	142	34	128	106.70.030
	174	34	160	106.70.031
	206	34	192	106.70.032
grau, eloxiert	142	34	128	106.70.050
	174	34	160	106.70.051
	206	34	192	106.70.052
schwarz, eloxiert	142	34	128	106.70.040
	174	34	160	106.70.041
	206	34	192	106.70.042
schwarz, rau, matt, lackiert	142	34	128	106.70.060
	174	34	160	106.70.061
	206	34	192	106.70.062

Abpackung: 1 oder 50 Stück

passend zu Regalsystem	► MB 8.69 A
passender Möbelknopf	► MB 1.122 A
Gewindeschrauben M4	► MB 1.470

1

Möbelgriffe Trend

Häfele Design Modell H1965

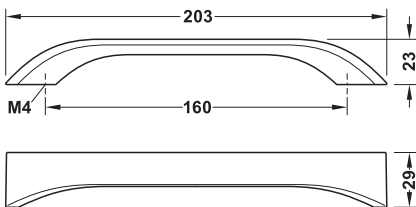
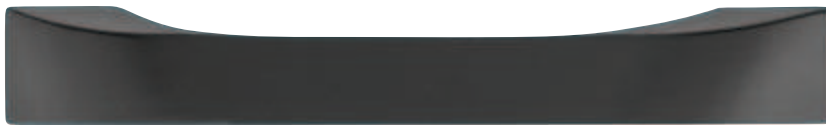

Oberfläche/Farbe	Artikel-Nr.
edelstahlfarben, eloxiert	106.60.100
schwarz, RAL 9017, matt, lackiert	106.60.101

Abpackung: 1, 25 oder 100 Stück

Gewindeschrauben M4

► MB 1.470

DGH-M 2018; HDE-de, 06/18; Maßangaben unverbindlich. Konstruktionsänderungen vorbehalten.

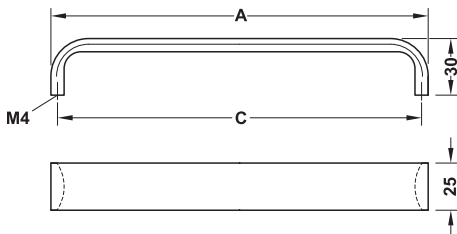

Oberfläche/Farbe	Maß A mm	Maß C mm	Artikel-Nr.
verchromt poliert	135	128	116.04.225
	199	192	116.04.227
	487	480	116.04.229
edelstahlfarben	135	128	116.04.625
	199	192	116.04.627
	487	480	116.04.629
schwarz gebürstet	135	128	116.04.325
	199	192	116.04.327
	487	480	116.04.329

Abpackung: 1 oder 25 Stück

Gewindeschrauben M4

► MB 1.470

DGH-M 2017, HIDE-de, 01/17; Maßangaben unverbindlich. Konstruktionsänderungen vorbehalten.

Möbelgriffe Trend

**DIESE SEITE WURDE BEWUSST  
LEER GELASSEN**

**INTENTIONAL BLANK PAGE**

Modell H1310

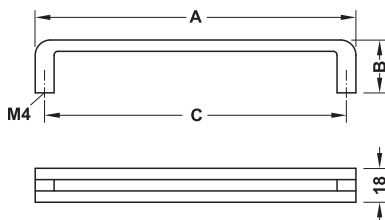

Oberfläche/Farbe	Maß A mm	Maß B mm	Maß C mm	Artikel-Nr.
verchromt poliert	170	28	160	110.34.206
	202	28	192	110.34.207
vernickelt gebürstet	170	28	160	110.34.606
	202	28	192	110.34.607
weiß, RAL 9016, matt, lackiert	170	28	160	110.34.706
	202	28	192	110.34.707
schwarz, RAL 9017, matt, lackiert	170	28	160	110.34.306
	202	28	192	110.34.307

Abpackung: 1 oder 10 Stück

Gewindeschrauben M4

► MB 1.470

1



Möbelgriffe Trend

Modell H1375

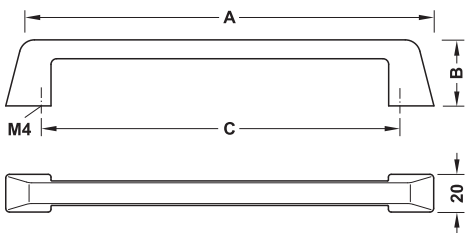
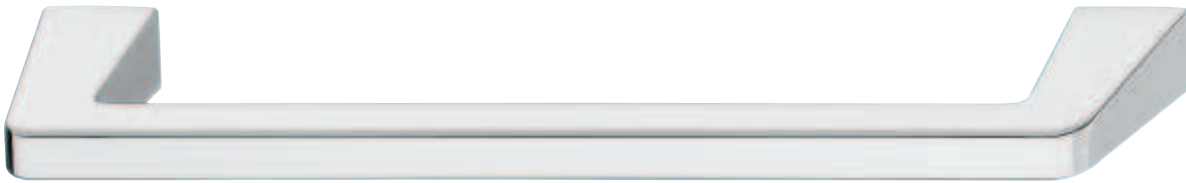

Oberfläche	Maß A mm	Maß B mm	Maß C mm	Artikel-Nr.
verchromt	227	35	192	106.69.267
poliert	355	35	320	106.69.268
vernickelt	227	35	192	106.69.667
gebürstet	355	35	320	106.69.668

Abpackung: 1 oder 25 Stück

Gewindeschrauben M4

► MB 1.470

DGH-M 2018; HDE-de, 06/18; Maßangaben unverbindlich. Konstruktionsänderungen vorbehalten.

Modell H1380



Beim Griff 110.35.020 wurden bewusst Gebrauchsspuren eingearbeitet. Dadurch ist jeder Griff ein Unikat.



1



Möbelgriffe Trend

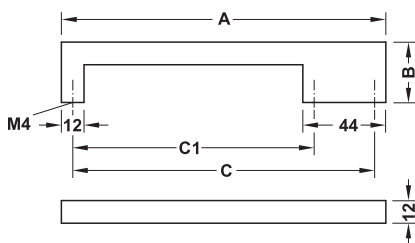

Oberfläche/ Farbe	Maß A mm	Maß B mm	Maß C1 mm	Maß C mm	Artikel-Nr.
verchromt poliert	172	32	128	160	110.34.255
	204	32	160	192	110.34.257
vernickelt gebürstet	172	32	128	160	110.34.655
	204	32	160	192	110.34.657
weiß, RAL 9016, matt, lackiert	172	32	128	160	110.34.356
	204	32	160	192	110.34.358
weißaluminium, lackiert	172	32	128	160	110.35.620
schwarz, RAL 9017, matt, lackiert	172	32	128	160	110.34.355
	204	32	160	192	110.34.357
eisenfarben, Used Look	172	32	128	160	110.35.020

Abpackung: 1 oder 10 Stück

Gewindeschrauben M4

► MB 1.470

DGH-M 2018, HDE-de, 06/18; Maßangaben unverbindlich. Konstruktionsänderungen vorbehalten.



1



Möbelgriffe Trend

Modell H1510

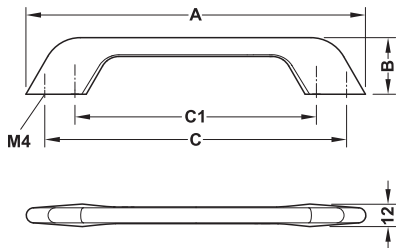

Oberfläche/ Farbe	Maß A mm	Maß B mm	Maß C1 mm	Maß C mm	Artikel-Nr.
verchromt poliert	212	30	160	192	106.61.214
	340	30	288	320	106.61.217
vernickelt gebürstet	212	30	160	192	106.61.014
	340	30	288	320	106.61.017

Abpackung: 1 oder 10 Stück

Gewindeschrauben M4

► MB 1.470

DGH-M 2018; HDE-de, 06/18; Maßangaben unverbindlich. Konstruktionsänderungen vorbehalten.

Modell H1515

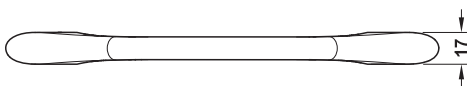
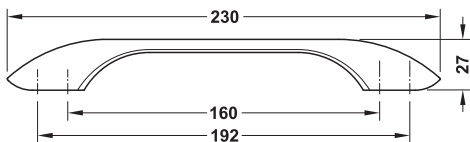

Oberfläche/Farbe	Artikel-Nr.
verchromt poliert	106.61.204
vernickelt gebürstet	106.61.004
vernickelt schwarz poliert	106.61.304

Abpackung: 1 oder 10 Stück

Gewindeschrauben M4

► MB 1.470

DGH-M 2018, HIDE-de, 06/18; Maßangaben unverbindlich. Konstruktionsänderungen vorbehalten.

1  
 CAD  
 Möbelgriffe Trend

Modell H1525

1



Möbelgriffe Trend



Bei den Oberflächen bronze matt, verzinkt antik und verkupfert antik wurden bewusst Gebrauchsspuren eingearbeitet. Dadurch ist jeder Griff ein Unikat.

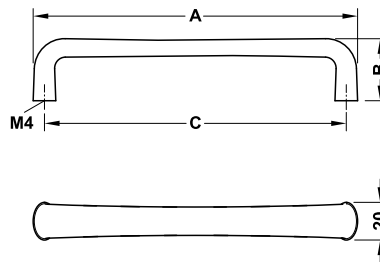

Oberfläche/ Farbe	Maß A mm	Maß B mm	Maß C mm	Abpackung Stück	Artikel-Nr.
verchromt	172	33	160	1 oder 15	106.61.254
poliert	332	33	320	1 oder 10	106.61.259
vernickelt	172	33	160	1 oder 15	106.61.054
gebürstet	332	33	320	1 oder 10	106.61.059
vernickelt	172	33	160	1 oder 15	106.61.354
schwarz poliert	332	33	320	1 oder 10	106.61.359
vernickelt	172	33	160	1 oder 10	106.61.554
schwarz gebürstet	332	33	320	1 oder 10	106.61.559
bronze matt	172	33	160	1 oder 15	106.61.154
	332	33	320	1 oder 10	106.61.159
verzinkt antik, Used Look	172	33	160	1 oder 15	106.61.954
	332	33	320	1 oder 10	106.61.959
verkupfert antik, Used Look	172	33	160	1 oder 15	106.61.454
	332	33	320	1 oder 10	106.61.459
rosésilber- farben	172	33	160	1 oder 15	106.63.716
	332	33	320	1 oder 10	106.63.719
roségold- farben	172	33	160	1 oder 15	106.63.816
	332	33	320	1 oder 10	106.63.819

Gewindeschrauben M4

► MB 1.470

DGH-M 2018; HDE-de, 06/18; Maßangaben unverbindlich. Konstruktionsänderungen vorbehalten.

Modell H1530



Bei diesen Griffen wurden bewusst Gebrauchsspuren eingearbeitet. Dadurch ist jeder Griff ein Unikat.



Möbelgriffe Trend

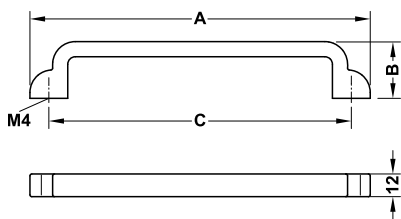

Oberfläche/Farbe	Maß A mm	Maß B mm	Maß C mm	Artikel-Nr.
vermessingt antik, Used Look	148	30	128	106.61.143
	180	30	160	106.61.144
oil rubbed bronze, Used Look	148	30	128	106.61.043
	180	30	160	106.61.044
verzinkt antik, Used Look	148	30	128	106.61.943
	180	30	160	106.61.944

Abpackung: 1 oder 10 Stück

DGH-M 2018, HIDE-de, 06/18; Maßangaben unverbindlich. Konstruktionsänderungen vorbehalten.

Gewindeschrauben M4

► MB 1.470

1



Möbelgriffe Trend

Modell H1565



Bei den Griffen 106.61.123 und 106.61.124 wurden bewusst Gebrauchsspuren eingearbeitet. Dadurch ist jeder Griff ein Unikat.

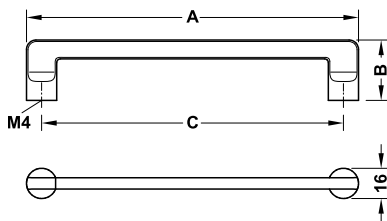

Oberfläche/Farbe	Maß A mm	Maß B mm	Maß C mm	Artikel-Nr.
verchromt poliert	144	32	128	106.61.223
	176	32	160	106.61.224
schwarz vernickelt gebürstet, Used Look	144	32	128	106.61.323
	176	32	160	106.61.324
oil rubbed bronze, Used Look	144	32	128	106.61.123
	176	32	160	106.61.124

Abpackung: 1 oder 10 Stück

Gewindeschrauben M4

► MB 1.470

DGH-M 2018; HDE-de, 06/18; Maßangaben unverbindlich. Konstruktionsänderungen vorbehalten.

Modell H1570



Bei diesen Griffen wurden bewusst Gebrauchsspuren eingearbeitet. Dadurch ist jeder Griff ein Unikat.



Möbelgriffe Trend

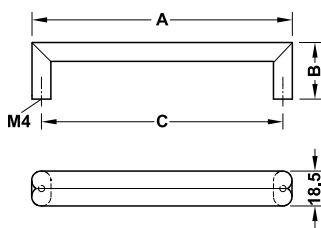

Oberfläche	Maß A mm	Maß B mm	Maß C mm	Artikel-Nr.
verzinnt antik, Used Look	138 170	30 30	128 160	106.61.933 106.61.934
verkupfert antik, Used Look	138 170	30 30	128 160	106.61.033 106.61.034

Abpackung: 1 oder 10 Stück

DGH-M 2018, HIDE-de, 06/18; Maßangaben unverbindlich. Konstruktionsänderungen vorbehalten.

Gewindeschrauben M4

► MB 1.470



1

GAEB

CAD

Möbelgriffe Trend



Bei diesen Griffen wurden bewusst Gebrauchsspuren eingearbeitet. Dadurch ist jeder Griff ein Unikat.

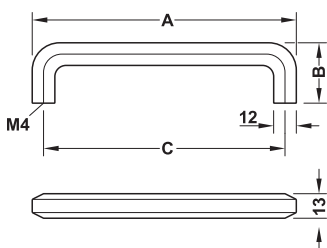

Oberfläche/Farbe	Maß A mm	Maß B mm	Maß C mm	Artikel-Nr.
vermessingt gebürstet	108	32	96	106.62.504
	140	32	128	106.62.505
	172	32	160	106.62.506
verzinkt antik	108	32	96	106.62.904
	140	32	128	106.62.905
	172	32	160	106.62.906
verkupfert antik	108	32	96	106.62.004
	140	32	128	106.62.005
	172	32	160	106.62.006
vernickelt schwarz gebürstet	108	32	96	106.62.604
	140	32	128	106.62.605
	172	32	160	106.62.606
schwarz, RAL 9005	108	32	96	106.62.304
	140	32	128	106.62.305
	172	32	160	106.62.306

Abpackung: 1 oder 10 Stück

Gewindeschrauben M4

► MB 1.470

DGH-M 2018; HDE-de, 06/18; Maßangaben unverbindlich. Konstruktionsänderungen vorbehalten.



Modell H1715

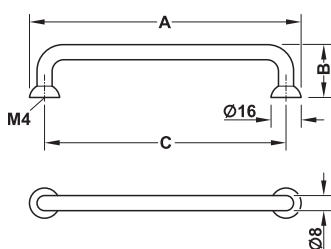
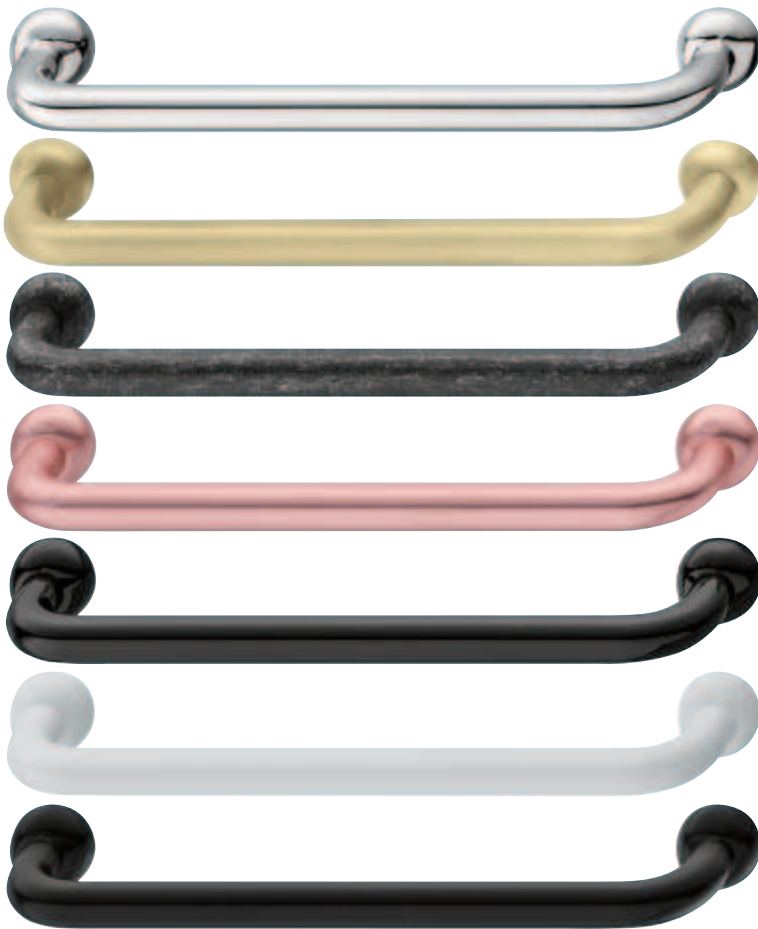
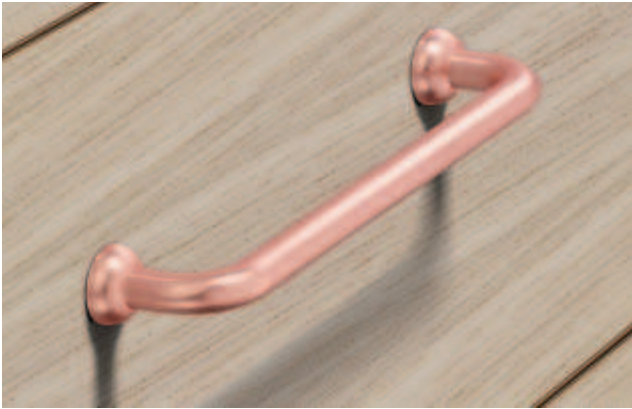

Oberfläche/Farbe	Maß A mm	Maß B mm	Maß C mm	Artikel-Nr.
verchromt poliert	144	28	128	106.62.215
	176	28	160	106.62.216
vermessingt gebürstet	144	28	128	106.62.515
	176	28	160	106.62.516
verzinkt antik	144	28	128	106.62.915
	176	28	160	106.62.916
verkupfert poliert	144	28	128	106.62.015
	176	28	160	106.62.016
vernickelt schwarz poliert	144	28	128	106.62.315
	176	28	160	106.62.316
weiß, matt	144	28	128	106.62.715
	176	28	160	106.62.716
schwarz, matt	144	28	128	106.62.115
	176	28	160	106.62.116

Gewindeschrauben M4

► MB 1.470

Abpackung: 1 oder 10 Stück

1



Möbelgriffe Trend

Modell H1720

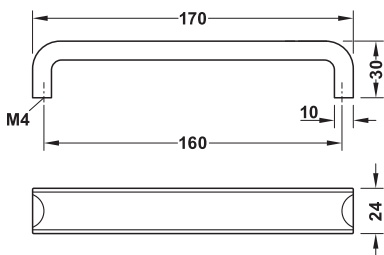

Oberfläche/Farbe	Artikel-Nr.
verzinkt antik	106.65.146
silberfarben, matt	106.65.646
rosésilberfarben	106.65.746
anthrazitfarben	106.65.446
schwarz, matt	106.65.346

Abpackung: 1 oder 15 Stück

passender Möbelknopf	► MB 1.124
Gewindeschrauben M4	► MB 1.470

DGH-M 2018; HDE-de, 06/18; Maßangaben unverbindlich. Konstruktionsänderungen vorbehalten.

Modell H1730

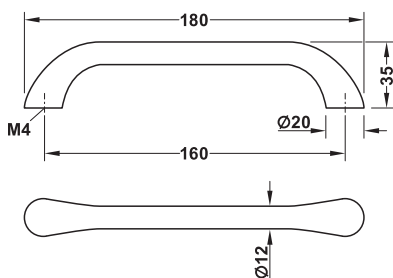
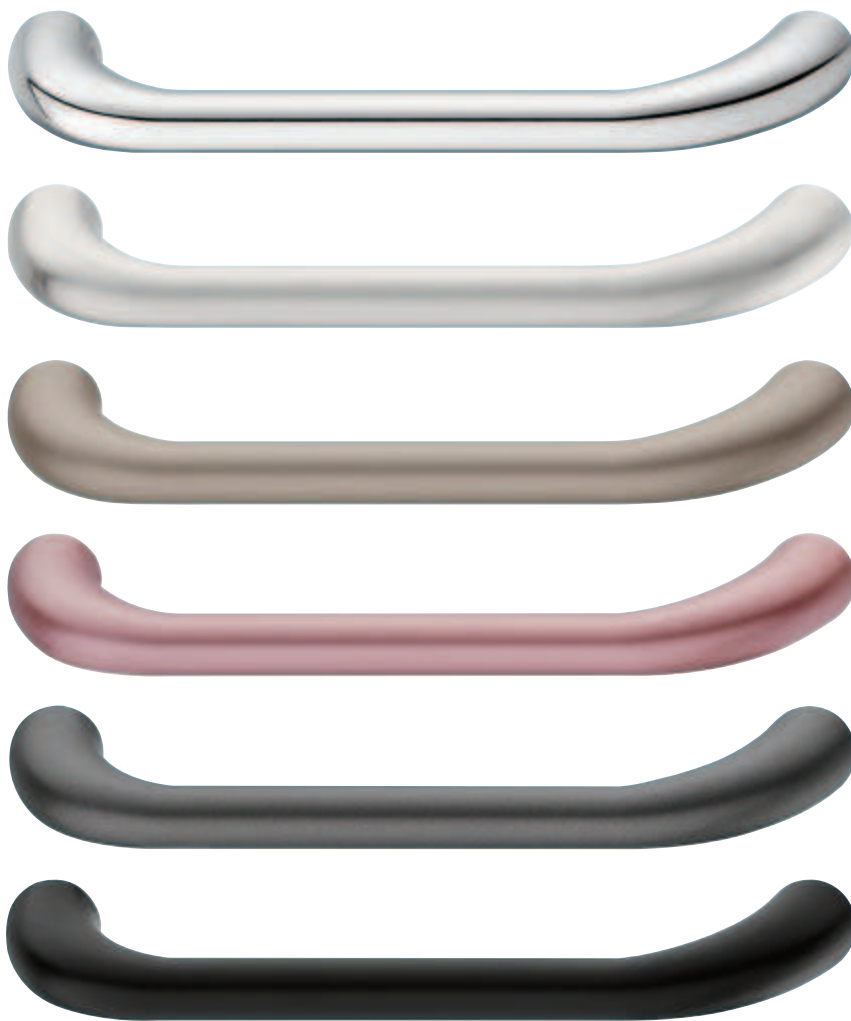

Oberfläche/Farbe	Artikel-Nr.
verchromt poliert	106.65.266
vernickelt gebürstet	106.65.066
champagnerfarben, matt	106.65.566
roségoldfarben	106.65.866
anthrazitfarben	106.65.466
schwarz, matt	106.65.366

Abpackung: 1 oder 15 Stück

Gewindeschrauben M4

► MB 1.470

DGH-M 2018, HDE-de, 06/18; Maßangaben unverbindlich. Konstruktionsänderungen vorbehalten.

1



Möbelgriffe Trend

1



Möbelgriffe Trend

Modell H1735

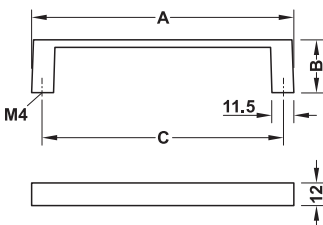
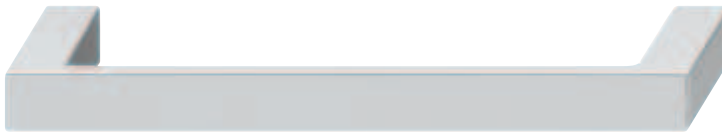

Oberfläche/Farbe	Maß A mm	Maß B mm	Maß C mm	Artikel-Nr.
verchromt poliert	139	28	128	106.62.225
	171	28	160	106.62.226
vernickelt gebürstet	139	28	128	106.62.625
	171	28	160	106.62.626
vermessingt antik	139	28	128	106.62.525
	171	28	160	106.62.526
schwarz gebürstet, Used Look	139	28	128	106.62.425
	171	28	160	106.62.426

Abpackung: 1 oder 10 Stück

Gewindeschrauben M4

► MB 1.470

DGH-M 2018; HDE-de, 06/18; Maßangaben unverbindlich. Konstruktionsänderungen vorbehalten.

Modell H1750

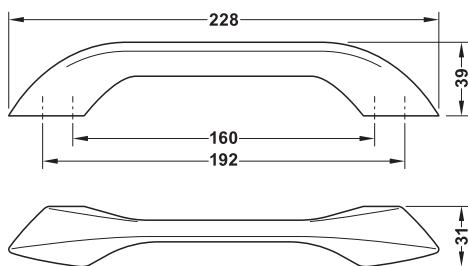
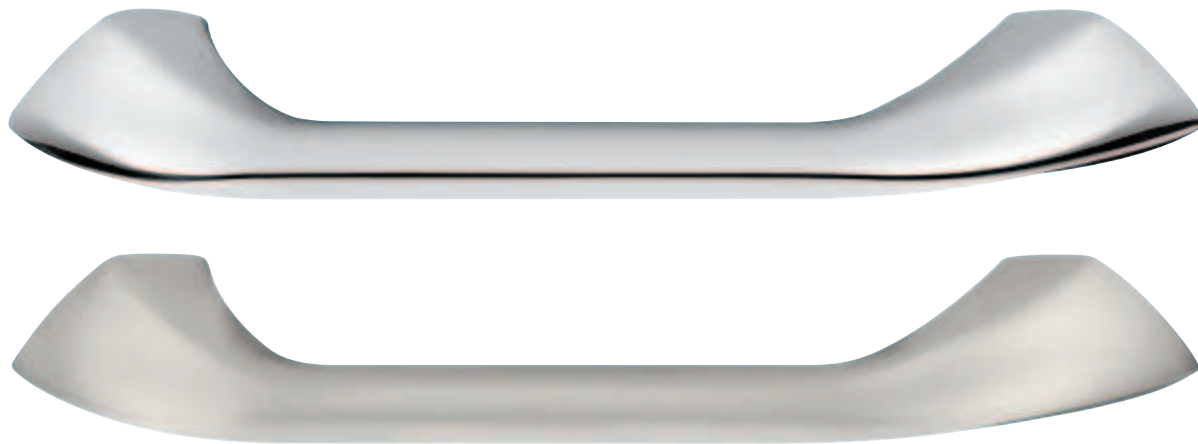

Oberfläche/Farbe	Artikel-Nr.
verchromt poliert	106.62.256
vernickelt gebürstet	106.62.656

Abpackung: 1 oder 5 Stück

DGH-M 2018, HDE-de, 06/18; Maßangaben unverbindlich. Konstruktionsänderungen vorbehalten.

Gewindeschrauben M4

► MB 1.470

1  
 GAEB  
 CAD  
 Möbelgriffe Trend

1



Möbelgriffe Trend

Modell H1755

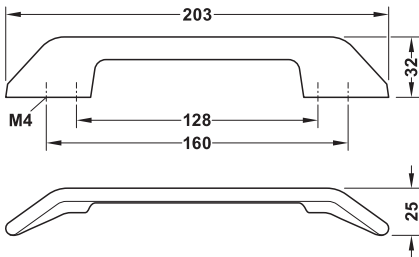

Oberfläche/Farbe	Artikel-Nr.
verchromt poliert	106.62.265
vernickelt gebürstet	106.62.665
vernickelt schwarz poliert	106.62.365
vernickelt schwarz gebürstet	106.62.165

Abpackung: 1 oder 10 Stück

Gewindeschrauben M4

► MB 1.470

DGH-M 2018; HDE-de, 06/18; Maßangaben unverbindlich. Konstruktionsänderungen vorbehalten.



Modell H1760



Bei den Griffen 106.62.475 und 106.62.476 wurden bewusst Gebrauchsspuren eingearbeitet. Dadurch ist jeder Griff ein Unikat.



Möbelgriffe Trend

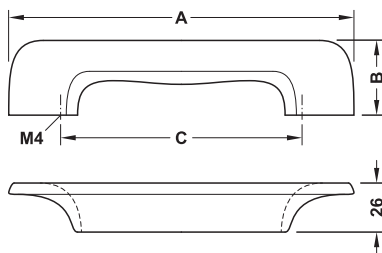

Oberfläche/Farbe	Maß A mm	Maß B mm	Maß C mm	Artikel-Nr.
weiß, matt	183	48	128	106.62.775
	215	48	160	106.62.776
schwarz, matt	183	48	128	106.62.175
	215	48	160	106.62.176
eisenfarben, Used Look	183	48	128	106.62.475
	215	48	160	106.62.476

Abpackung: 1 oder 10 Stück

Gewindeschrauben M4

► MB 1.470

DGH-M 2018, HIDE-de, 06/18; Maßangaben unverbindlich. Konstruktionsänderungen vorbehalten.

1



Möbelgriffe Trend

Modell H1770

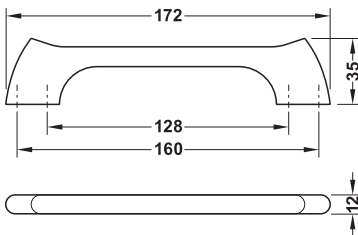

Oberfläche/Farbe	Artikel-Nr.
verchromt poliert	106.62.295
vernickelt matt	106.62.695
schwarz, matt	106.62.195

Abpackung: 1 oder 10 Stück

Gewindeschrauben M4

► MB 1.470

DGH-M 2018; HDE-de, 06/18; Maßangaben unverbindlich. Konstruktionsänderungen vorbehalten.

Häfele Design Modell H1915



Gehrungsoptik passend zum Industrial Style und rauen Materialien wie Beton, Stahl, Stein und grob strukturierten Holzelementen.



1

Möbelgriffe Trend

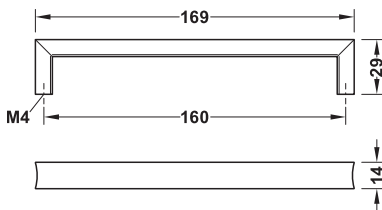

Oberfläche/Farbe	Artikel-Nr.
verzinkt antik	106.70.010
schwarz, RAL 9017, matt, lackiert	106.70.011
vernickelt gebürstet	106.70.013

Abpackung: 1 oder 40 Stück

DGH-M 2018, HIDE-de, 06/18; Maßangaben unverbindlich. Konstruktionsänderungen vorbehalten.

Gewindeschrauben M4

► MB 1.470

29.07.2019  
 ID 4588

Häfele Design Modell H1920

Möbelgriffe Trend



Minimalismus und sehr dünne Linienführung des Griffs unterstützen eine filigrane Raumgestaltung.

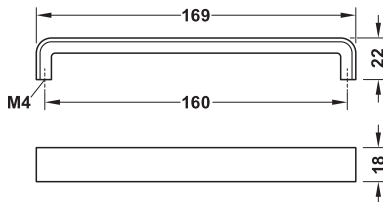
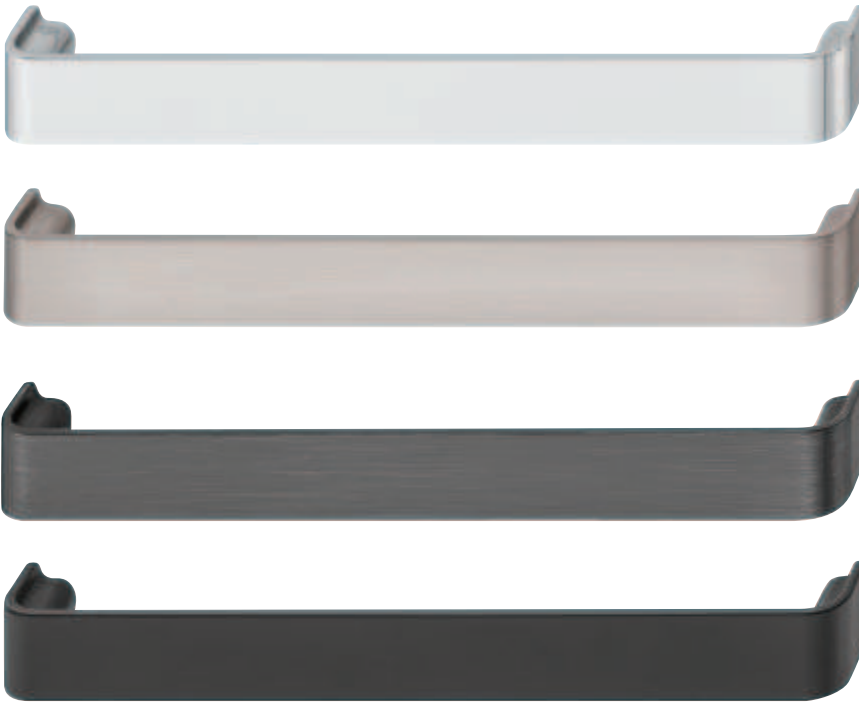

Oberfläche/Farbe	Artikel-Nr.
verchromt poliert	106.69.460
vernickelt gebürstet	106.69.461
vernickelt schwarz gebürstet	106.69.462
schwarz, RAL 9017, matt, lackiert	106.69.463

Abpackung: 1, 10 oder 100 Stück

Gewindeschrauben M4

► MB 1.470

DGH-M 2018; HDE-de, 06/18; Maßangaben unverbindlich. Konstruktionsänderungen vorbehalten.

Häfele Design Modell H1955



1

Möbelgriffe Trend

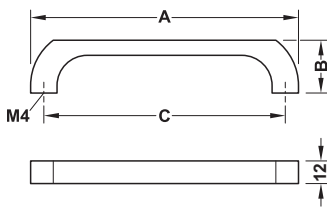

Oberfläche/Farbe	Maß A mm	Maß B mm	Maß C mm	Artikel-Nr.
verchromt matt	110	28	96	106.69.480
	142	28	128	106.69.481
	174	28	160	106.69.482
vernickelt gebürstet	110	28	96	106.69.470
	142	28	128	106.69.471
	174	28	160	106.69.472
verzinkt antik	110	28	96	106.69.490
	142	28	128	106.69.491
	174	28	160	106.69.492

DGH-M 2018, HIDE-de, 06/18; Maßangaben unverbindlich. Konstruktionsänderungen vorbehalten.

Gewindeschrauben M4

► MB 1.470

29.07.2019  
 ID 4588

1

Möbelgriffe Trend

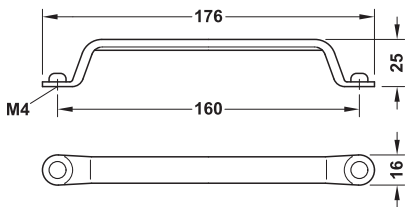

Oberfläche	Artikel-Nr.
verzinkt	106.69.691
vermessingt antik	106.69.692
verchromt poliert	106.69.693
schwarz matt	106.69.694

Abpackung: 1 oder 25 Stück

Gewindeschrauben M4

► MB 1.470

DGH-M 2017, HDE-de, 01/17; Maßangaben unverbindlich. Konstruktionsänderungen vorbehalten.



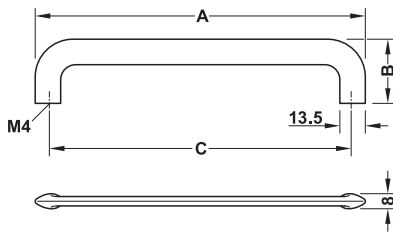

Oberfläche	Maß A mm	Maß B mm	Maß C mm	Artikel-Nr.
edelstahlfarben	79	35	64	111.71.000
	175	35	160	111.71.001
	335	35	320	111.71.002
schwarz matt	79	35	64	111.71.010
	175	35	160	111.71.011
	335	35	320	111.71.012

Abpackung: 1 oder 10 Stück

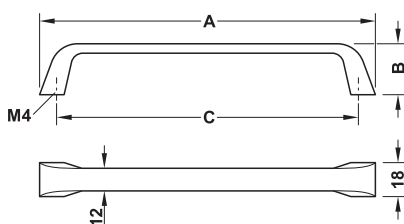

Oberfläche	Maß A mm	Maß B mm	Maß C mm	Artikel-Nr.
vermessingt antik gebürstet	178	27	160	102.27.050
vernickelt schwarz	178	27	160	102.27.051

Abpackung: 1, 20 oder 100 Stück

Gewindeschrauben M4

► MB 1.470

DGH-M 2018, HDE-de, 06/18; Maßangaben unverbindlich. Konstruktionsänderungen vorbehalten.

1

Möbelgriffe Trend

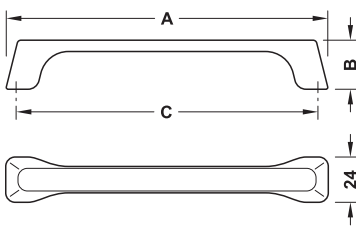

Oberfläche/Farbe	Maß A mm	Maß B mm	Maß C mm	Artikel-Nr.
schwarz matt, Kanten kupferfarben aufgehellt	171	26	160	111.77.637
altsilber glänzend				111.77.636
schwarz matt, Used Look				111.77.635

Abpackung: 1 oder 25 Stück

Gewindeschrauben M4

► MB 1.470

DGH-M 2018; HDE-de, 06/18; Maßangaben unverbindlich. Konstruktionsänderungen vorbehalten.

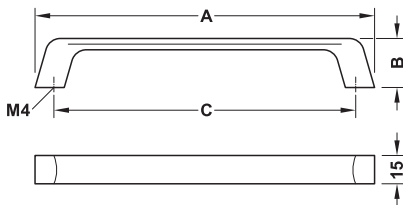

Oberfläche/Farbe	Maß A mm	Maß B mm	Maß C mm	Artikel-Nr.
schwarz matt, Used Look	340	26	320	111.77.631
	180	26	160	111.77.626
goldfarben matt gebürstet	180	26	160	111.77.625
	340	26	320	111.77.630
altsilber glänzend	180	26	160	111.77.627
	340	26	320	111.77.632

Abpackung: 1 oder 25 Stück

DGH-M 2018, HDE-de, 06/18; Maßangaben unverbindlich. Konstruktionsänderungen vorbehalten.

Gewindeschrauben M4

► MB 1.470

23.08.2018  
ID 4137



1



Möbelgriffe Trend



Bei diesen Griffen wurden bewusst Gebrauchsspuren eingearbeitet. Dadurch ist jeder Griff ein Unikat.

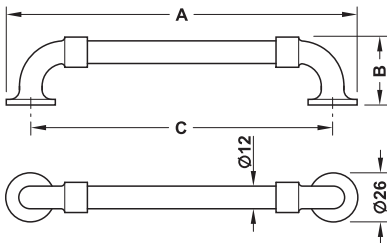

Oberfläche/Farbe	Maß A mm	Maß B mm	Maß C mm	Artikel-Nr.
schwarz matt used look	186	36	160	111.77.640
	346	36	320	111.77.645

Abpackung: 1 oder 25 Stück

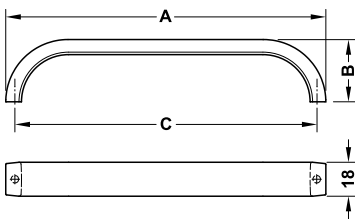
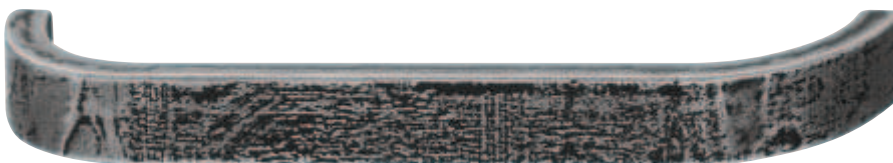

> Oberfläche: eisenfarben, Used Look

Maß A mm	Maß B mm	Maß C mm	Artikel-Nr.
170	33	160	111.53.016
330	33	320	111.53.019

Abpackung: 1 oder 10 Stück

Gewindeschrauben M4

► MB 1.470

DGH-M 2018; HDE-de, 06/18; Maßangaben unverbindlich. Konstruktionsänderungen vorbehalten.



Bei diesen Griffen wurden bewusst Gebrauchsspuren eingearbeitet. Dadurch ist jeder Griff ein Unikat. 

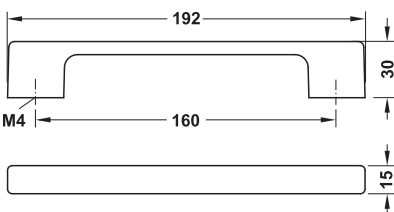

Oberfläche/Farbe	Artikel-Nr.
eisenfarben, Fläche aufgehell, Used Look	110.22.036
vernickelt antik, Used Look	110.22.736
titanfarben lackiert	110.22.536

Abpackung: 1 oder 25 Stück

Gewindeschrauben M4	► MB 1.470
passende Möbelknöpfe	► MB 1.125

DGH-M 2018, HIDE-de, 06/18; Maßangaben unverbindlich. Konstruktionsänderungen vorbehalten.

1

Möbelgriffe Trend

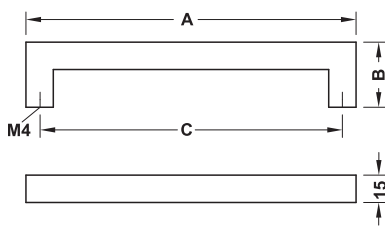

Oberfläche/Farbe	Maß A mm	Maß B mm	Maß C mm	Artikel-Nr.
verzinkt antik	143	35	128	155.01.900
	175	35	160	155.01.910
	207	35	192	155.01.920
bronzefarben geölt	143	35	128	155.01.902
	175	35	160	155.01.912
	207	35	192	155.01.922
silberfarben antik	143	35	128	155.01.903
	175	35	160	155.01.913
	207	35	192	155.01.923
verchromt poliert	143	35	128	155.01.904
	175	35	160	155.01.914
	207	35	192	155.01.924
vermessingt gebürstet	143	35	128	155.01.905
	175	35	160	155.01.915
	207	35	192	155.01.925

Abpackung: 1 Stück

passende Möbelknöpfe ▶ MB 1.125

Gewindeschrauben M4 ▶ MB 1.470

DGH-M 2018; HDE-de, 06/18; Maßangaben unverbindlich. Konstruktionsänderungen vorbehalten.



**DIESE SEITE WURDE BEWUSST  
LEER GELASSEN**

**INTENTIONAL BLANK PAGE**

1



Möbelgriffe Trend



Bei diesen Griffen wurden bewusst Gebrauchsspuren eingearbeitet. Dadurch ist jeder Griff ein Unikat.

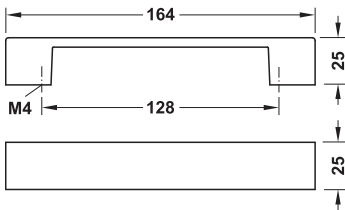

Oberfläche/Farbe	Artikel-Nr.
eisenfarben, Kanten aufgehell, Used Look	109.50.017

Abpackung: 1 oder 25 Stück

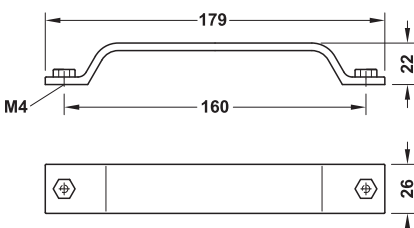
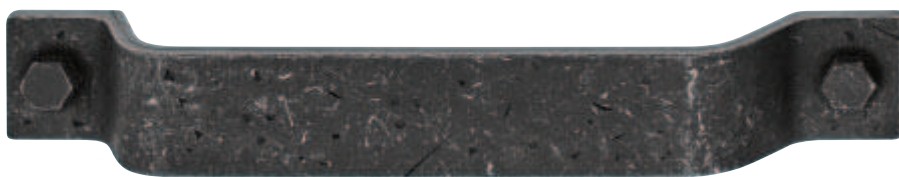

Oberfläche/Farbe	Artikel-Nr.
eisenfarben, Used Look	110.22.016
verzinkt antik, Used Look	110.22.926

Abpackung: 1 oder 25 Stück

Gewindeschrauben M4

► MB 1.470

DGH-M 2018; HDE-de, 06/18; Maßangaben unverbindlich. Konstruktionsänderungen vorbehalten.

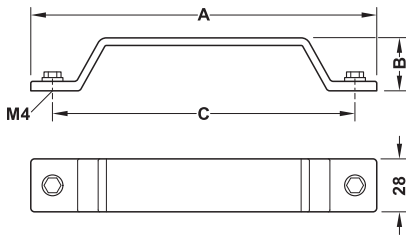

Oberfläche/ Farbe	Maß A mm	Maß B mm	Maß C mm	Abpackung Stück	Artikel-Nr.
eisenfarben	183	29	160	1 oder 10	116.60.200
	247	29	224	1 oder 25	116.60.201
vermessingt antik	183	29	160	1 oder 10	116.60.220
	247	29	224	1 oder 25	116.60.221

DGH-M 2018, HIDE-de, 06/18; Maßangaben unverbindlich. Konstruktionsänderungen vorbehalten.

Gewindeschrauben M4

► MB 1.470

06.09.2019  
 ID 4629

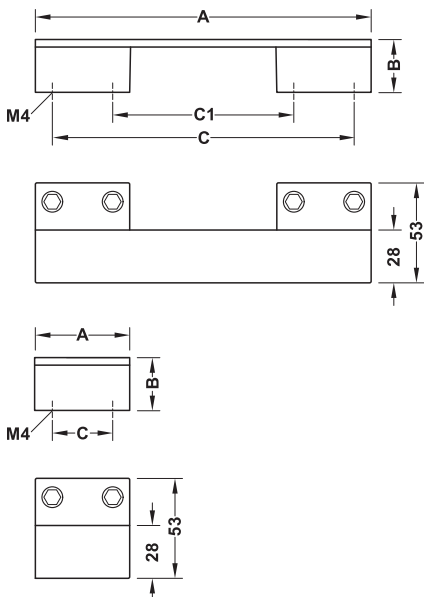

Oberfläche/ Farbe	Maß A mm	Maß B mm	Maß C mm	Maß C1 mm	Abpackung Stück	Artikel-Nr.
eisenfarben	50	28	32	–	1 oder 25	120.70.895
	178	28	160	96	1 oder 10	120.70.918
verzinkt antik	50	28	32	–	1 oder 25	120.70.919
	178	28	160	96	1 oder 10	120.70.920

Gewindeschrauben M4

► MB 1.470

DGH-M 2018; HDE-de, 06/18; Maßangaben unverbindlich. Konstruktionsänderungen vorbehalten.



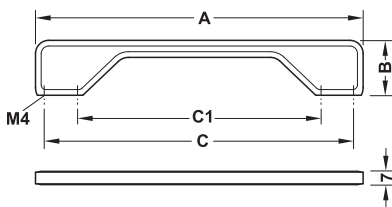

Oberfläche	Maß A mm	Maß B mm	Maß C1 mm	Maß C mm	Artikel-Nr.
verchromt poliert	174	29	128	160	113.96.212
	238	29	192	224	113.96.214
	334	29	288	320	113.96.217
edelstahl- farben	174	29	128	160	113.96.012
	238	29	192	224	113.96.014
	334	29	288	320	113.96.017

Abpackung: 1 oder 10 Stück

Bei diesen Griffen wurden bewusst Gebrauchsspuren eingearbeitet. Dadurch ist jeder Griff ein Unikat.

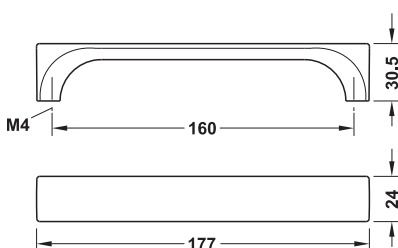

Oberfläche/Farbe	Artikel-Nr.
Flechtwerk, anthrazitfarben lackiert, Used Look	101.13.516

Abpackung: 1 oder 10 Stück

Gewindeschrauben M4

► MB 1.470

1



Möbelgriffe Trend



Bei den Griffen 101.13.506 und 101.13.106 wurden bewusst Gebrauchsspuren eingearbeitet. Dadurch ist jeder Griff ein Unikat.

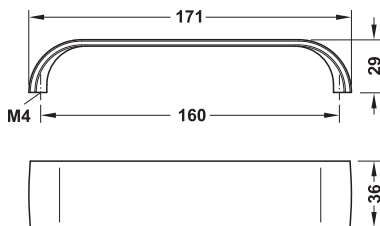

Oberfläche/Farbe	Artikel-Nr.
edelstahlfarben	101.13.006
anthrazitfarben lackiert, Fläche aufgehellt, Used Look	101.13.506
messingfarben lackiert, Fläche aufgehellt, Used Look	101.13.106

Abpackung: 1 oder 10 Stück

Gewindeschrauben M4

► MB 1.470

DGH-M 2018; HDE-de, 06/18; Maßangaben unverbindlich. Konstruktionsänderungen vorbehalten.



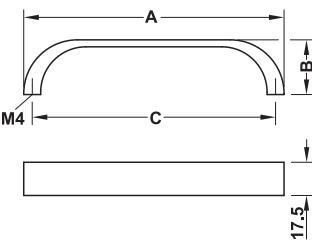

Oberfläche/Farbe	Maß A mm	Maß B mm	Maß C mm	Artikel-Nr.
vernickelt gebürstet	139	29	128	155.02.025
	171	29	160	155.02.030
vermessingt gebürstet	139	29	128	155.02.026
	171	29	160	155.02.031
schwarz matt, RAL 9017	139	29	128	155.02.027
	171	29	160	155.02.032

Abpackung: 1 oder 30 Stück

Gewindeschrauben M4

► MB 1.470

DGH-M 2018, HIDE-de, 06/18; Maßangaben unverbindlich. Konstruktionsänderungen vorbehalten.

Möbelgriffe Trend

**DIESE SEITE WURDE BEWUSST  
LEER GELASSEN**

**INTENTIONAL BLANK PAGE**

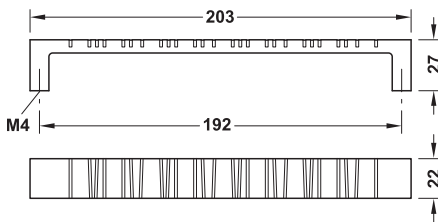

Oberfläche	Artikel-Nr.
verchromt poliert	109.50.284

Abpackung: 1 oder 50 Stück

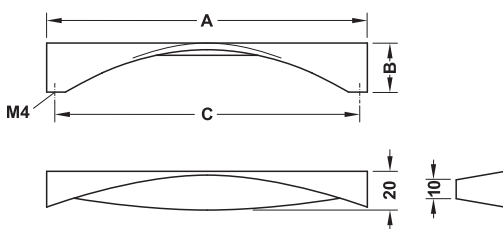

Oberfläche	Maß A mm	Maß B mm	Maß C mm	Artikel-Nr.
verchromt poliert	170	26	160	111.64.213
verchromt poliert	340	26	320	111.64.218
vernickelt gebürstet	170	26	160	111.64.613
vernickelt gebürstet	340	26	320	111.64.618

Abpackung: 1 oder 25 Stück

Gewindeschrauben M4

► MB 1.470

DGH-M 2018, HIDE-de, 06/18; Maßangaben unverbindlich. Konstruktionsänderungen vorbehalten.

1

Möbelgriffe Trend

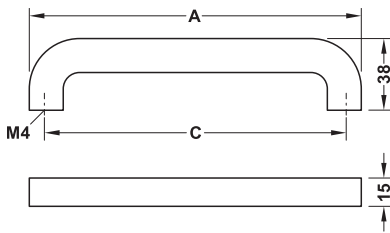

Werkstoff	Oberfläche	Maß A mm	Maß C mm	Artikel-Nr.
Eiche	natur lackiert	176	160	191.67.091
		208	192	191.67.100
		240	224	191.67.111
Esche	schwarz gebeizt	176	160	191.67.090
		208	192	191.67.101
		240	224	191.67.110

Abpackung: 1 oder 25 Stück

Gewindeschrauben M4

► MB 1.470

DGH-M 2018; HDE-de, 06/18; Maßangaben unverbindlich. Konstruktionsänderungen vorbehalten.

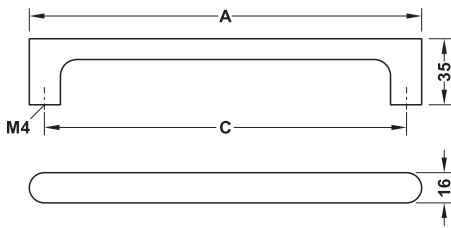

Werkstoff	Oberfläche	Maß A mm	Maß C mm	Artikel-Nr.
Eiche	natur lackiert	144	128	191.67.031
		208	192	191.67.040
		272	256	191.67.051
Esche	schwarz gebeizt	144	128	191.67.030
		208	192	191.67.041
		272	256	191.67.050

Abpackung: 1 oder 25 Stück

DGH-M 2018, HIDE-de, 06/18; Maßangaben unverbindlich. Konstruktionsänderungen vorbehalten.

Gewindeschrauben M4

► MB 1.470

05.03.2020  
ID 4911

**DIESE SEITE WURDE BEWUSST  
LEER GELASSEN**

**INTENTIONAL BLANK PAGE**



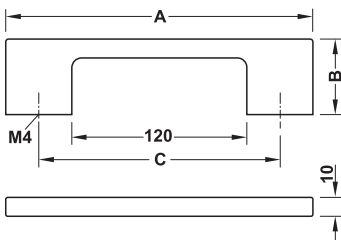

> Werkstoff: HPL-Schichtstoff

Oberfläche	Maß A mm	Maß B mm	Maß C mm	Artikel-Nr.
Decklage: Aluminium gebürstet Kanten: schwarz / silberfarben	190 350	40 40	160 320	194.17.913 194.17.908
Decklage: schwarz Kanten: schwarz / silberfarben	190 350	40 40	160 320	194.17.313 194.17.308

Abpackung: 1 oder 10 Stück

DGH-M 2018, HIDE-de, 06/18; Maßangaben unverbindlich. Konstruktionsänderungen vorbehalten.

Gewindeschrauben M4

► MB 1.470

1



Möbelgriffe Trend



Durocarbon:  
recyceltes High-Tech Material mit reinen Carbonfasern

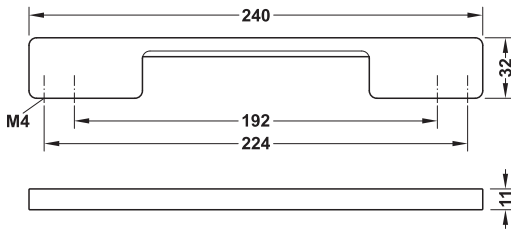

> Werkstoff: Durocarbon

Farbe	Artikel-Nr.
anthrazit	113.10.348

Abpackung: 1 oder 10 Stück

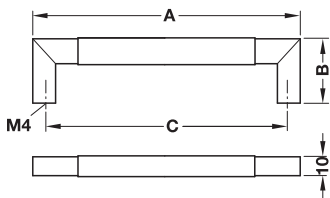

> Werkstoff: Griff: Zinkdruckguss,  
Einlage: Leder

Oberfläche/Farbe	Maß A mm	Maß B mm	Maß C mm	Artikel-Nr.
Einlage: kastanienbraun,	140	34	128	111.71.412
Griff: verchromt matt	172	34	160	111.71.413

Abpackung: 1 oder 10 Stück

Gewindeschrauben M4

► MB 1.470

DGH-M 2018; HDE-de, 06/18; Maßangaben unverbindlich. Konstruktionsänderungen vorbehalten.

Modell H1365

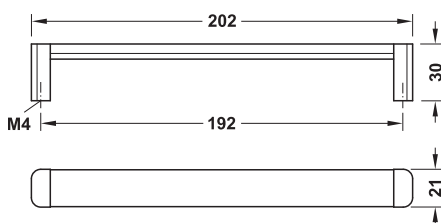

> Werkstoff: Griff: Aluminium,  
Sockel: Zinkdruckguss

Oberfläche/Farbe	Artikel-Nr.
Griff: weiß, RAL 9016, Sockel: verchromt poliert	106.69.217
Griff: weiß, RAL 9016, Sockel: vernickelt gebürstet	106.69.617
Griff: schwarz, RAL 9017, Sockel: verchromt poliert	106.69.227
Griff: schwarz, RAL 9017, Sockel: vernickelt gebürstet	106.69.627

Abpackung: 1 oder 25 Stück

Gewindeschrauben M4

► MB 1.470

DGH-M 2018, HDE-de, 06/18; Maßangaben unverbindlich. Konstruktionsänderungen vorbehalten.

1  
GAEB  
CAD  
Möbelgriffe Trend

1

Möbelgriffe Trend

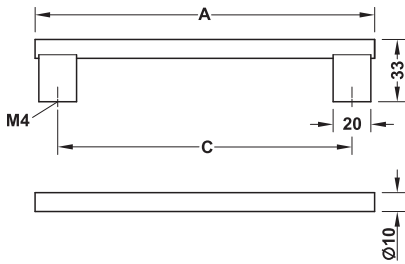

Oberfläche	Maß A mm	Maß C mm	Artikel-Nr.
edelstahlfarben	182	160	132.19.110
	278	256	132.19.111
	1200	1178	132.19.112
messingfarben gebürstet	182	160	132.19.120
	278	256	132.19.121
	1200	1178	132.19.122
schwarz gebürstet	182	160	132.19.115
	278	256	132.19.116
	1200	1178	132.19.117

Abpackung: 1 oder 25 Stück

Gewindeschrauben M4

► MB 1.470

passender Möbelknopf

► MB 1.121 A

DGH-M 2017, HDE-de, 01/17; Maßangaben unverbindlich. Konstruktionsänderungen vorbehalten.

**Häfele Design Modell H2110**

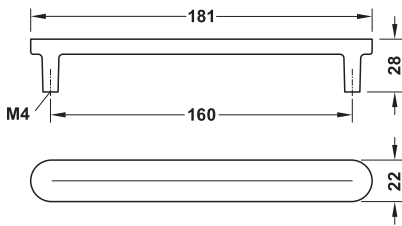

Oberfläche/Farbe	Artikel-Nr.
grau, metallic	106.70.091
dunkelgrau, matt	106.70.090

Abpackung: 1 oder 20 Stück

DGH-M 2017, HIDE-de, 01/17; Maßangaben unverbindlich. Konstruktionsänderungen vorbehalten.

Gewindeschrauben M4

► MB 1.470

25.06.2020  
ID 5101



1

Möbelgriffe Trend

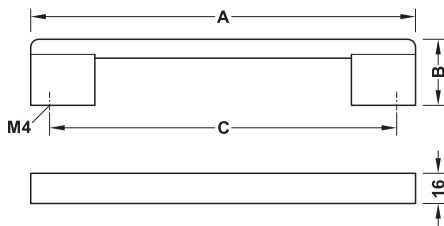

Oberfläche	Maß A mm	Maß B mm	Maß C mm	Artikel-Nr.
edelstahloptik hell eloxiert gebürstet	148	35	128	108.95.040
	180	35	160	108.95.041
	212	35	192	108.95.042
	244	35	224	108.95.043
	308	35	288	108.95.044
	372	35	352	108.95.045
schwarz eloxiert gebürstet	500	35	480	108.95.046
	148	35	128	108.95.050
	180	35	160	108.95.051
	212	35	192	108.95.052
	244	35	224	108.95.053
	308	35	288	108.95.054
	372	35	352	108.95.055
	500	35	480	108.95.056

Abpackung: 1 oder 25 Stück

Gewindeschrauben M4

► MB 1.470

DGH-M 2018; HDE-de, 06/18; Maßangaben unverbindlich. Konstruktionsänderungen vorbehalten.



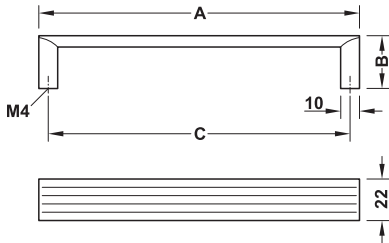
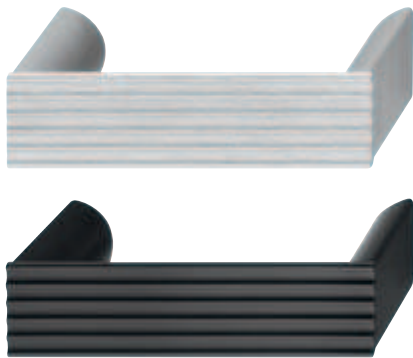

> Werkstoff: Aluminium, Sockel: Zinkdruckguss

Oberfläche	Maß A mm	Maß B mm	Maß C mm	Artikel-Nr.
edelstahlfarben	74	28	64	111.71.020
	170	28	160	111.71.021
	330	28	320	111.71.022
schwarz matt	74	28	64	111.71.030
	170	28	160	111.71.031
	330	28	320	111.71.032

Abpackung: 1 oder 10 Stück

DGH-M 2018, HIDE-de, 06/18; Maßangaben unverbindlich. Konstruktionsänderungen vorbehalten.

Gewindeschrauben M4

► MB 1.470

1



Möbelgriffe Trend

Modell H1345

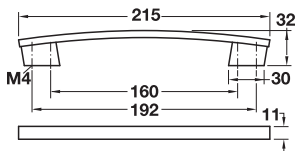

Oberfläche/Farbe	Artikel-Nr.
verchromt poliert	110.34.227
vernickelt gebürstet	110.34.627
weiß, RAL 9016 matt, lackiert	110.34.328
schwarz, RAL 9017 matt, lackiert	110.34.327

Abpackung: 1 oder 10Stück

Gewindeschrauben M4

► MB 1.470

DGH-M 2018; HDE-de, 06/18; Maßangaben unverbindlich. Konstruktionsänderungen vorbehalten.

**Modell H1740**

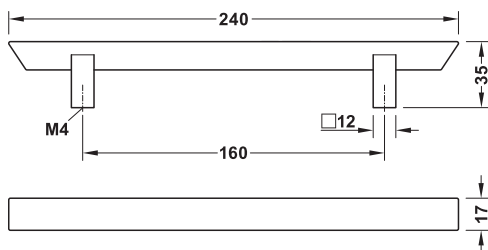
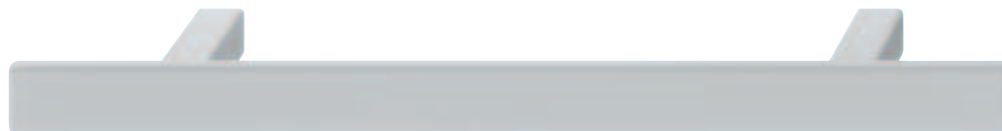

Oberfläche/Farbe	Artikel-Nr.
vernickelt gebürstet	106.62.636
weiß, matt	106.62.736
vernickelt schwarz gebürstet	106.62.336

Abpackung: 1 oder 10 Stück

Gewindeschrauben M4

► MB 1.470

DGH-M 2018, HIDE-de, 06/18; Maßangaben unverbindlich. Konstruktionsänderungen vorbehalten.

1  
 GAEB  
 CAD  
 Möbelgriffe Trend

Häfele Design Modell H1910



Textile Struktur schafft ein interessantes Griffgefühl und eine wohnlige Atmosphäre.

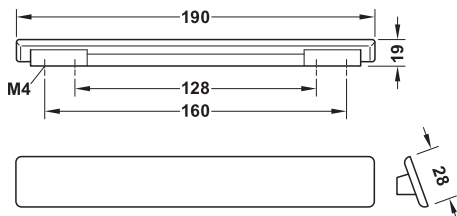
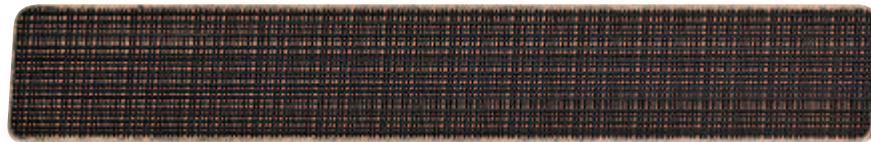
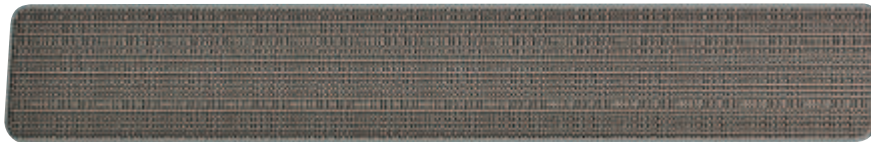

Oberfläche/Farbe	Artikel-Nr.
champagnerfarben, matt	106.70.000
vermessingt poliert	106.70.005
vermessingt antik	106.70.006
schwarz, RAL 9017, matt, lackiert	106.70.003

Abpackung: 1 oder 30 Stück

Gewindeschrauben M4

► MB 1.470

DGH-M 2018; HDE-de, 06/18; Maßangaben unverbindlich. Konstruktionsänderungen vorbehalten.

**Häfele Design Modell H1925**



Neuinterpretation einer fast vergessenen Zeit –  
 Nouveau Art Deco.



1

Möbelgriffe Trend

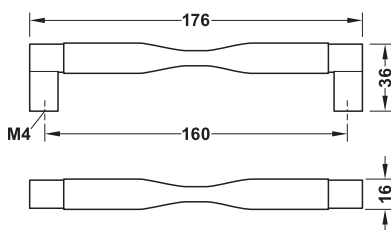

Oberfläche/Farbe	Artikel-Nr.
vermessingt gebürstet	106.69.402
vermessingt antik gebürstet	106.69.403
schwarz, RAL 9005	106.69.404

Abpackung: 1, 10 oder 50 Stück

DGH-M 2018, HIDE-de, 06/18; Maßangaben unverbindlich. Konstruktionsänderungen vorbehalten.

Gewindeschrauben M4

► MB 1.470

29.07.2019  
 ID 4588

Häfele Design Modell H1930

1

Möbelgriffe Trend

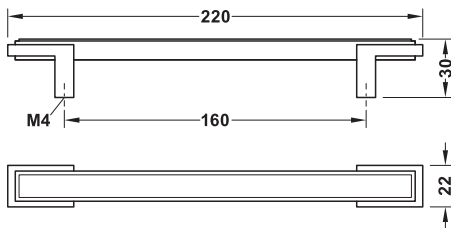

Oberfläche/Farbe	Artikel-Nr.
vermessingt antik gebürstet	106.69.413
bronze geölt	106.69.414
schwarz, RAL 9005	106.69.415

Abpackung: 1, 10 oder 50 Stück

Gewindeschrauben M4

► MB 1.470

DGH-M 2018; HDE-de, 06/18; Maßangaben unverbindlich. Konstruktionsänderungen vorbehalten.



Häfele Design Modell H1975



1

Möbelgriffe Trend

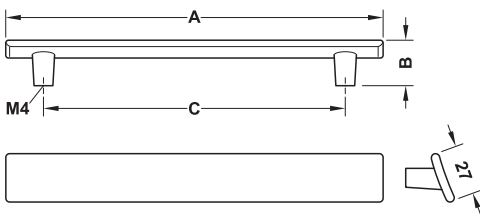

Oberfläche/Farbe	Maß A mm	Maß B mm	Maß C mm	Artikel-Nr.
vernickelt gebürstet	52	23	32	106.69.522
	200	23	160	106.69.512
vernickelt schwarz gebürstet	52	23	32	106.69.521
	200	23	160	106.69.511
schwarz, RAL 9017, matt	52	23	32	106.69.520
	200	23	160	106.69.510

Abpackung: 1, 10 oder 100 Stück

DGH-M 2018, HDE-de, 06/18; Maßangaben unverbindlich. Konstruktionsänderungen vorbehalten.

Gewindeschrauben M4

► MB 1.470

29.07.2019  
 ID 4588

1

Möbelgriffe Trend

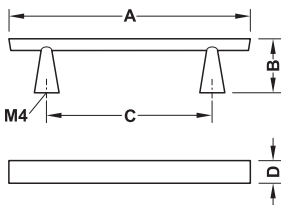
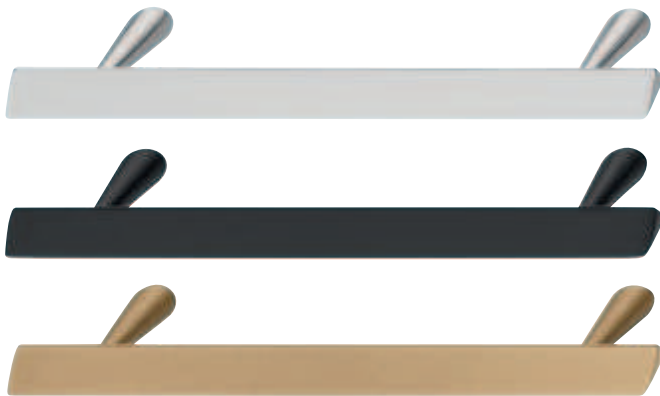

> Designer: Paul McCobb

Oberfläche/Farbe	Maß A mm	Maß B mm	Maß C mm	Maß D mm	Artikel-Nr.
verchromt poliert	92	23	64	10	102.04.140
	128	25	96	12	102.04.150
schwarz	92	23	64	10	102.04.141
	128	25	96	12	102.04.151
goldfarben	92	23	64	10	102.04.142
	128	25	96	12	102.04.152

Abpackung: 1 oder 10 Stück

Gewindeschrauben M4

► MB 1.470

DGH-M 2018; HDE-de, 06/18; Maßangaben unverbindlich. Konstruktionsänderungen vorbehalten.

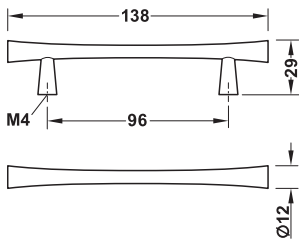
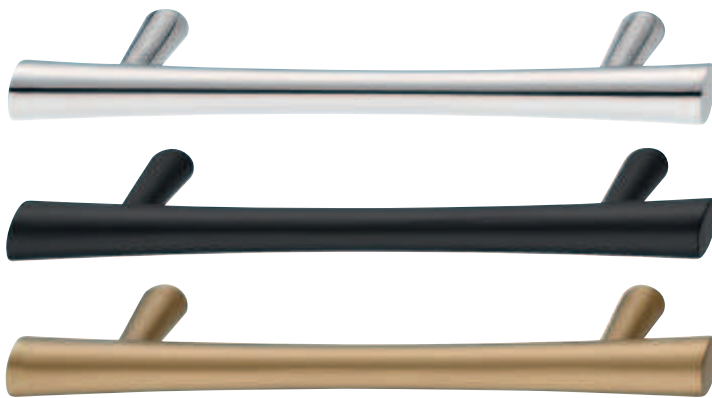

> Designer: Paul McCobb

Oberfläche/Farbe	Artikel-Nr.
verchromt poliert	102.04.160
schwarz	102.04.161
goldfarben	102.04.162

Abpackung: 1 oder 10 Stück

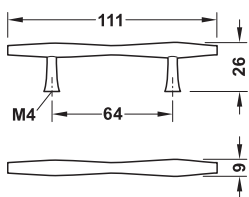
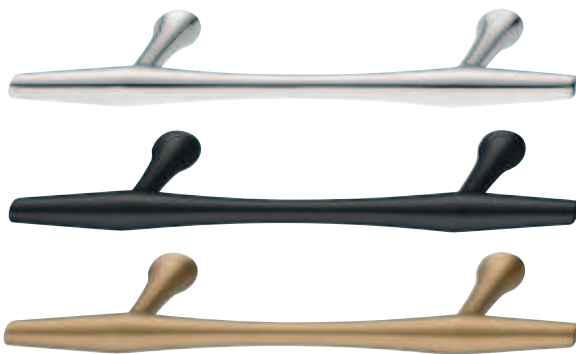

> Designer: Paul McCobb

Oberfläche/Farbe	Artikel-Nr.
verchromt poliert	102.04.170
schwarz	102.04.171
goldfarben	102.04.172

Abpackung: 1 oder 10 Stück

Gewindeschrauben M4

► MB 1.470

DGH-M 2018, HIDE-de, 06/18; Maßangaben unverbindlich. Konstruktionsänderungen vorbehalten.

Häfele Design Modell H2115

1

Möbelgriffe Trend

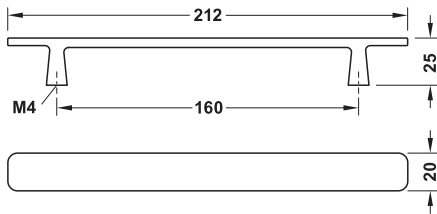

Oberfläche/Farbe	Artikel-Nr.
vernickelt, gebürstet	106.69.010
schwarz, vernickelt, gebürstet	106.69.011

Abpackung: 1 oder 10 Stück

Gewindeschrauben M4

► MB 1.470

DGH-M 2017, HDE-de, 01/17; Maßangaben unverbindlich. Konstruktionsänderungen vorbehalten.

**Häfele Design Modell H2120, Durchmesser 12 mm**

1



Möbelgriffe Trend

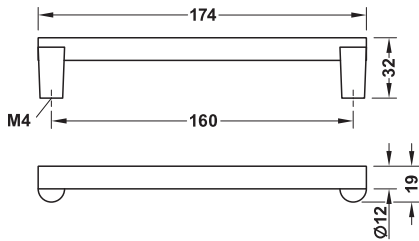

Oberfläche/Farbe	Artikel-Nr.
vernickelt, gebürstet	106.69.020
verzinkt, antik	106.69.021

Abpackung: 1 oder 10 Stück

DGH-M 2017, HDE-de, 01/17; Maßangaben unverbindlich. Konstruktionsänderungen vorbehalten.

Gewindeschrauben M4

► MB 1.470

25.06.2020  
 ID 5101

Häfele Design Modell H2125

1

Möbelgriffe Trend

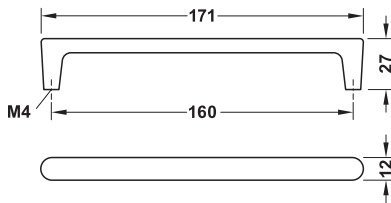

Oberfläche/Farbe	Artikel-Nr.
vernickelt, gebürstet	106.69.030
gebürstet, Used Look	106.69.031

Abpackung: 1 oder 10 Stück

Gewindeschrauben M4

► MB 1.470

DGH-M 2017, HDE-de, 01/17; Maßangaben unverbindlich. Konstruktionsänderungen vorbehalten.



**DIESE SEITE WURDE BEWUSST  
LEER GELASSEN**

**INTENTIONAL BLANK PAGE**

1



Möbelgriffe Trend



Bei diesen Produkten wurden bewusst Gebrauchsspuren eingearbeitet. Dadurch ist jedes Produkt ein Unikat.

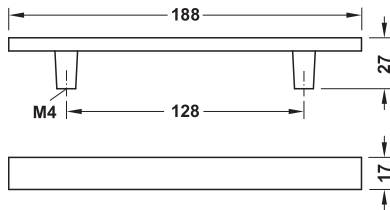

Oberfläche/Farbe	Artikel-Nr.
eisenfarben, Used Look	102.04.017
vernickelt antik, Used Look	102.04.617

Abpackung: 1 oder 25 Stück

Gewindeschrauben M4

► MB 1.470

DGH-M 2018; HDE-de, 06/18; Maßangaben unverbindlich. Konstruktionsänderungen vorbehalten.

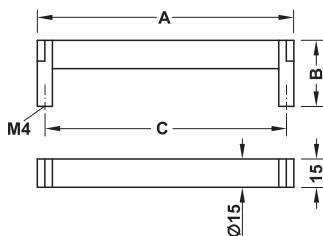
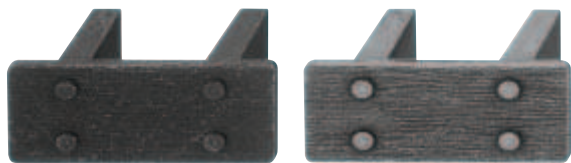

Bei diesen Griffen wurden bewusst Gebrauchsspuren eingearbeitet. Dadurch ist jedes Produkt ein Unikat. 

1



Möbelgriffe Trend

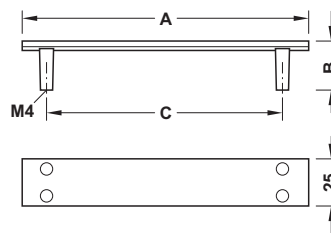

Oberfläche/Farbe	Maß A mm	Maß B mm	Maß C mm	Artikel-Nr.
schwarz, Used Look	58	26	32	110.34.361
	154	26	128	110.34.365
eisenfarben, Used Look	58	26	32	110.34.371
	154	26	128	110.34.375

Abpackung: 1 oder 25 Stück

- > Werkstoff: Griff: Edelstahl, Einlage: Leder
- > Oberfläche: Griff: matt gebürstet, Einlage: dunkelbraun

Maß A mm	Maß B mm	Maß C mm	Artikel-Nr.
136	35	128	112.48.012
200	35	192	112.48.014

Abpackung: 1 oder 10 Stück

Passender Möbelknopf ▶ MB 1.129

Gewindeschrauben M4 ▶ MB 1.470

DGH-M 2018, HDE-de, 06/18; Maßangaben unverbindlich. Konstruktionsänderungen vorbehalten.

1

Möbelgriffe Trend

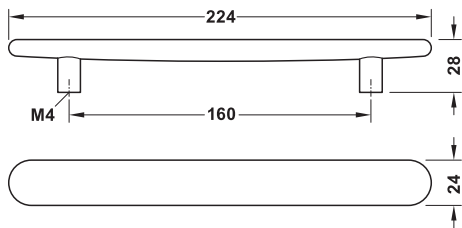

Werkstoff	Oberfläche	Artikel-Nr.
Eiche	natur lackiert	191.67.001
Esche	schwarz gebeizt	191.67.000

Abpackung: 1 oder 25 Stück

passende Möbelknöpfe	► MB 1.126 A
Gewindeschrauben M4	► MB 1.470

DGH-M 2018; HDE-de, 06/18; Maßangaben unverbindlich. Konstruktionsänderungen vorbehalten.

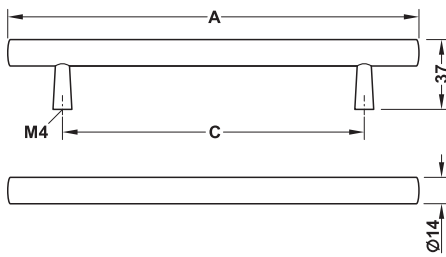

Werkstoff	Oberfläche	Maß A mm	Maß C mm	Artikel-Nr.
Griff: Eiche	Griff: natur	218	160	191.67.071
Sockel: Zinkdruckguss	Sockel: edelstahlfarben	282	224	191.67.080
Griff: Esche	Griff: schwarz gebeizt	218	160	191.67.070
Sockel: Messing	Sockel: gebürstet	282	224	191.67.081

Abpackung: 1 oder 25 Stück

DGH-M 2018, HIDE-de, 06/18; Maßangaben unverbindlich. Konstruktionsänderungen vorbehalten.

Gewindeschrauben M4

► MB 1.470

05.03.2020  
ID 4911

1



Möbelgriffe Trend



Die schräge Vertiefung des Griffes erlaubt ein angenehmes Schieben der Tür in beide Richtungen.



Funktionsbeschreibung

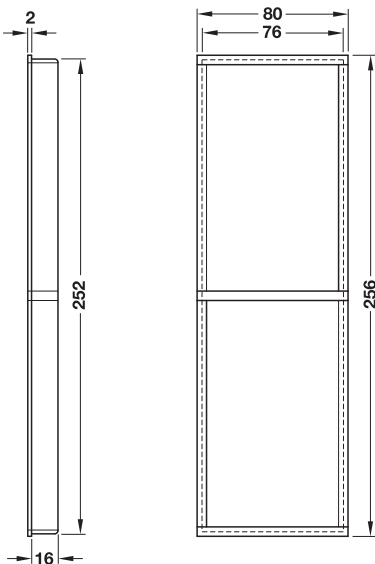
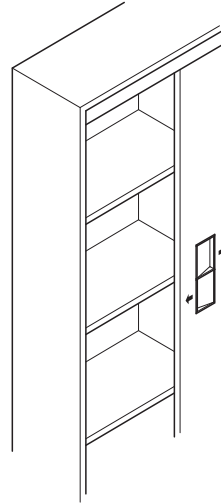

- > Werkstoff: Muschelgriff: Aluminium, Endkappen: Zinkdruckguss
- > Einsatzbereich: für Schiebetüren
- > Montage: schraubenlose Befestigung zum Kleben

Oberfläche	Artikel-Nr.
silberfarben	151.65.900

Abpackung: 1 oder 10 Stück



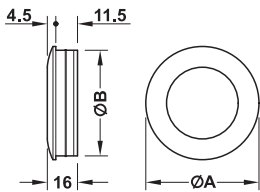

> Montage: zum Kleben

Oberfläche/Farbe	Maß A mm	Maß B mm	Artikel-Nr.
schwarz matt	40	36,0	111.75.620
	60	55,8	111.75.621

Abpackung: 1 oder 25 Stück

**Hinweis**

Zum Einkleben von Muschelgriffen empfehlen wir den Montagekleber Pattex PL 300 transparent, Art-Nr. 003.56.104

1

Möbelgriffe Trend

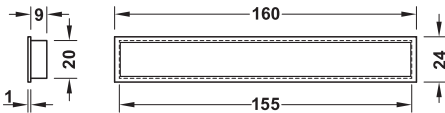

> Montage: zum Kleben

Oberfläche/Farbe	Artikel-Nr.
weiß matt	151.11.640
schwarz matt	151.11.641

Abpackung: 1 oder 25 Stück

**Hinweis**

Zum Einkleben von Muschelgriffen empfehlen wir den Montagekleber Pattex PL 300 transparent, Art-Nr. 003.56.104



Griff linke Tür

Griff rechte Tür

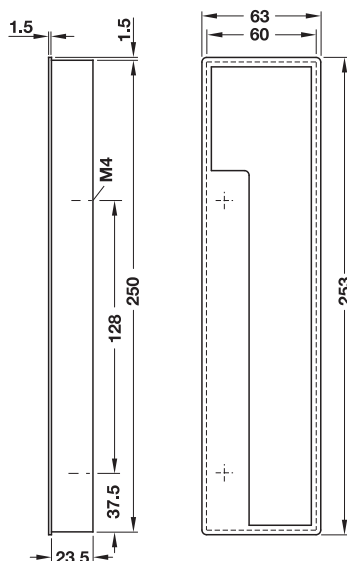

> Einsatzbereich: für Schiebetüren ab 25 mm Dicke

Oberfläche	Ausführung	Artikel-Nr.
aluminiumfarben	Griff linke Tür	152.08.912
	Griff rechte Tür	152.08.902

Abpackung: 1 oder 4 Stück

Gewindeschrauben M4

► MB 1.470

1



Möbelgriffe Trend

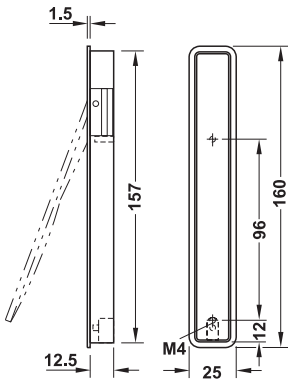

Oberfläche	Artikel-Nr.
aluminiumfarben	161.07.950
edelstahlfarben	161.07.050

Abpackung: 1 oder 25 Stück

**Hinweis**

Die maximale Zugbelastung dieses Griffes liegt bei 300 N.

Gewindeschrauben M4

► MB 1.470

DGH-M 2018; HDE-de, 06/18; Maßangaben unverbindlich. Konstruktionsänderungen vorbehalten.

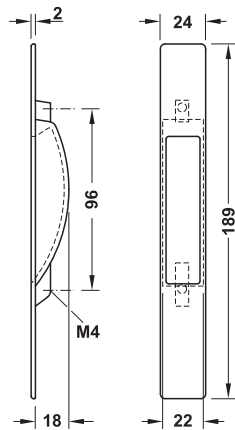

- > Einsatzbereich: für Schiebetüren
- > Montage: Vertikal, zum Schrauben oder Kleben

Oberfläche	Artikel-Nr.
verchromt poliert	152.08.204

Abpackung: 1 oder 15 Stück

DGH-M 2018, HIDE-de, 06/18; Maßangaben unverbindlich. Konstruktionsänderungen vorbehalten.

Gewindeschrauben M4

► MB 1.470

1

GAEB

CAD

Möbelgriffe Trend



- > integriertes und glattes Erscheinungsbild des Möbels
- > steht an der Möbelfront nicht vor
- > verhindert durch die geschlossenen Klappen Schmutzablagerungen in der Griffschale
- > angenehme Haptik und vollwertiger Griffraum erlauben optimales Öffnen



> Werkstoff: Frontplatte und Klappen: Zinkdruckguss, Rückteil: Kunststoff

Oberfläche/Farbe	Maß A mm	Maß B mm	Maß C mm	Artikel-Nr.
Frontplatte und Klappen: edelstahlfarben,	115	110	22	152.16.000
Rückteil: schwarz	155	150	27	152.16.001

Abpackung: 1 Stück

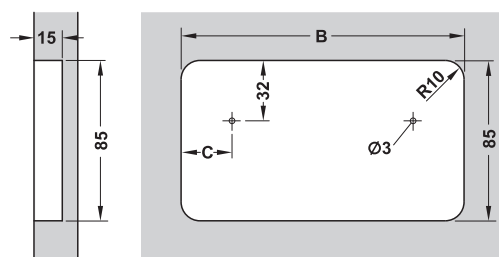
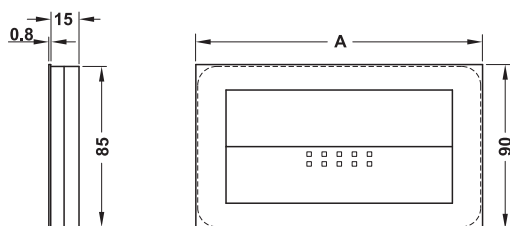

> Werkstoff: Frontplatte und Klappen: Zinkdruckguss, Rückteil: Kunststoff

Oberfläche/Farbe	Artikel-Nr.
Frontplatte und Klappen: edelstahlfarben, Rückteil: schwarz	152.16.003

Abpackung: 1 Stück

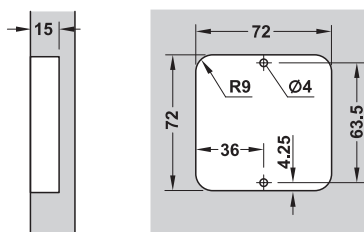
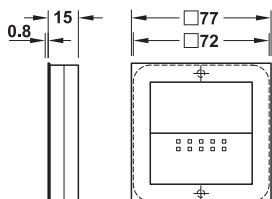

Spanplattenschrauben Panhead Hospa

► MB 1.470

DGH-M 2018; HDE-de, 06/18; Maßangaben unverbindlich. Konstruktionsänderungen vorbehalten.



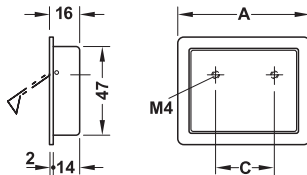

Oberfläche/Farbe	Maß A mm	Maß C mm	Artikel-Nr.
vernickelt gebürstet	70	59	111.75.610
	153	108	111.75.611

Abpackung: 1 oder 25 Stück

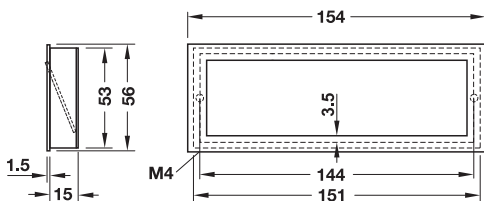

> Werkstoff: Griff: Zinkdruckguss,  
Rückteil: Kunststoff

Oberfläche/Farbe	Artikel-Nr.
Griff: aluminiumfarben, Rückplatte: schwarz	151.96.901
Griff: schwarz matt, Rückplatte: schwarz	151.96.902

Abpackung: 1 oder 15 Stück

Gewindeschrauben M4

► MB 1.470

1



Möbelgriffe Trend

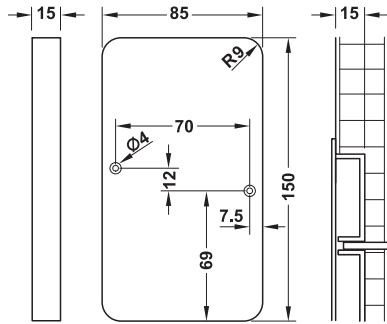
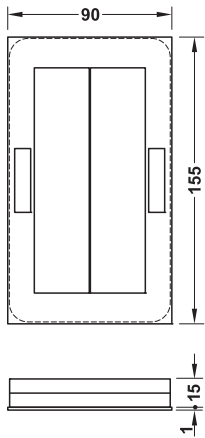

Montage: Griff einseitig

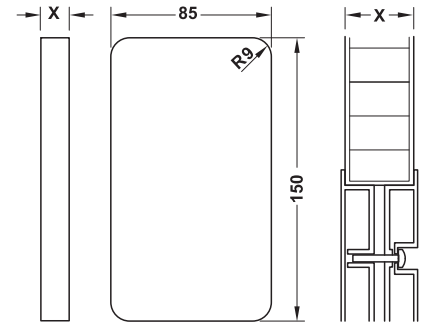

Montage: Griff beidseitig

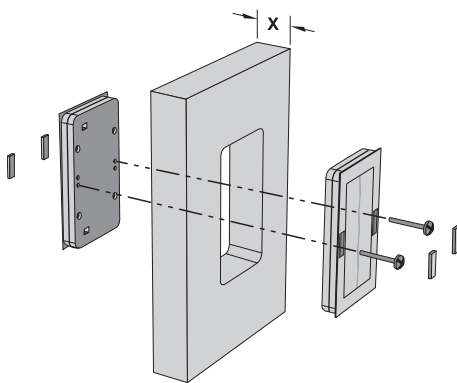

- > Werkstoff: Frontplatte und Klappen: Zinkdruckguss, Rückteil: Kunststoff
- > Einsatzbereich: für Möbel- und Raumschiebetüren

Oberfläche/Farbe	Artikel-Nr.
Frontplatte und Klappen: edelstahlfarben, Rückteil: schwarz	152.16.012

Abpackung: 1 Stück

Gewindeschrauben M4

► MB 1.470

DGH-M 2018; HDE-de, 06/18; Maßangaben unverbindlich. Konstruktionsänderungen vorbehalten.



Dieser Schiebetürgriff eignet sich besonders für flächenbündige Schiebetüren, bei denen die Türflügel zum Öffnen nach vorne und zur Seite über die anderen Türflügel geschoben werden.

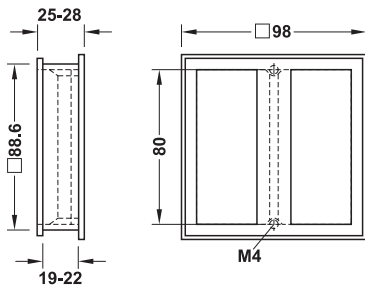

- > Ausführung: 2-teilig
- > Einsatzbereich: für Plattendicke 19 – 22 mm
- > Werkstoff: Zinkdruckguss

Oberfläche	Artikel-Nr.
vernickelt gebürstet	151.81.600

Abpackung: 1 oder 10 Stück

1

Möbelgriffe Trend

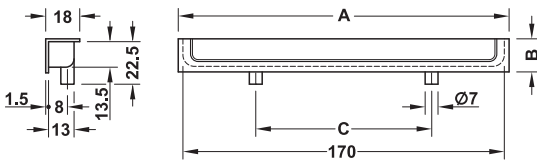
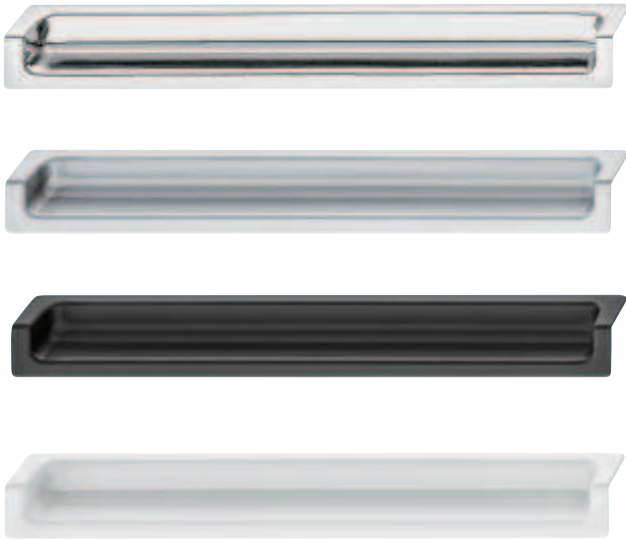
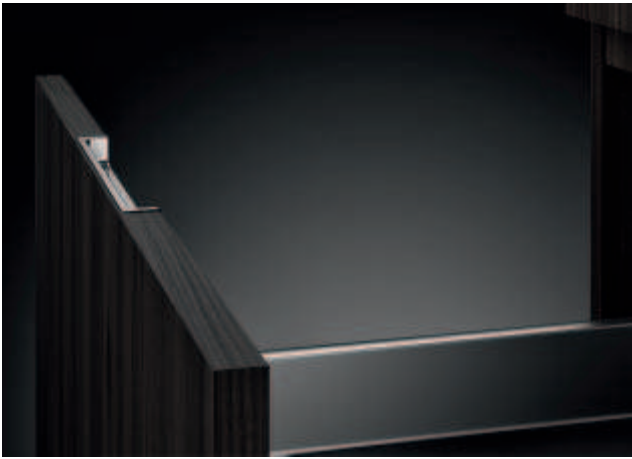

> Montage: schraubenlose Befestigung zum Eindrücken und Kleben

Oberfläche/Farbe	Maß A mm	Maß B mm	Maß C mm	Artikel-Nr.
verchromt poliert	177	24	96	155.01.940
	90	24	64	155.01.930
silberfarben, RAL 9006	177	24	96	155.01.941
	90	24	64	155.01.931
schwarz matt, RAL 9017	177	24	96	155.01.942
	90	24	64	155.01.932
weiß matt, RAL 9016	177	24	96	155.01.943
	90	24	64	155.01.933

Abpackung: 1 Stück

Gewindeschrauben M4

► MB 1.470

DGH-M 2018; HDE-de, 06/18; Maßangaben unverbindlich. Konstruktionsänderungen vorbehalten.

**DIESE SEITE WURDE BEWUSST  
LEER GELASSEN**

**INTENTIONAL BLANK PAGE**

1

Möbelgriffe Trend

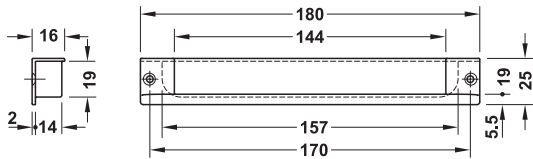
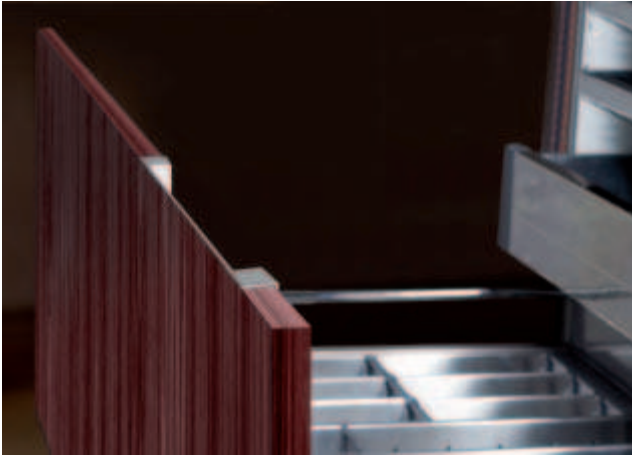

Oberfläche	Artikel-Nr.
aluminiumfarben	108.68.914

Abpackung: 1 oder 25 Stück

Spanplattenschrauben Hospa Senkkopf Ø 3.5 mm ► MB 1.470

DGH-M 2018; HDE-de, 06/18; Maßangaben unverbindlich. Konstruktionsänderungen vorbehalten.





Für ein glattes, griffloses Erscheinungsbild der Möbelfront eignet sich dieser Griff, der bündig oder aufliegend in die Kante eingelassen wird.



Möbelgriffe Trend

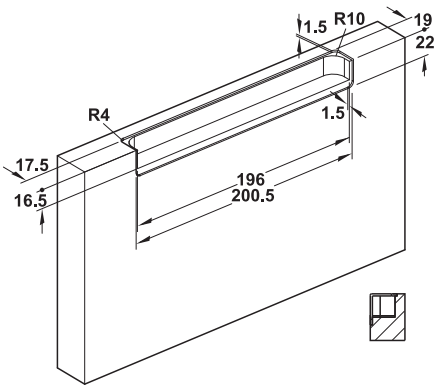

Einbauvariante eingelassen

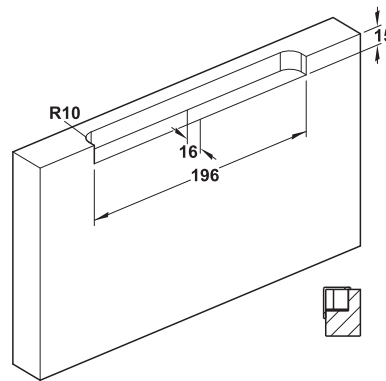

Einbauvariante aufgesetzt

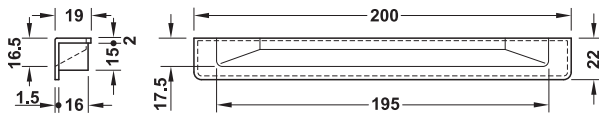

> Montage: schraubenlose Befestigung zum Kleben

Oberfläche	Artikel-Nr.
edelstahlfarben	151.58.600

Abpackung: 1 oder 20 Stück

DGH-M 2018, HIDE-de, 06/18; Maßangaben unverbindlich. Konstruktionsänderungen vorbehalten.

1



Möbelgriffe Trend

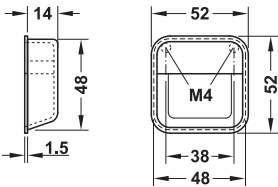

Oberfläche/Farbe	Artikel-Nr.
aluminiumfarben	151.11.981
weiß, matt	151.11.781

Abpackung: 1 oder 10 Stück

Gewindeschrauben M4

► MB 1.470

DGH-M 2018; HDE-de, 06/18; Maßangaben unverbindlich. Konstruktionsänderungen vorbehalten.

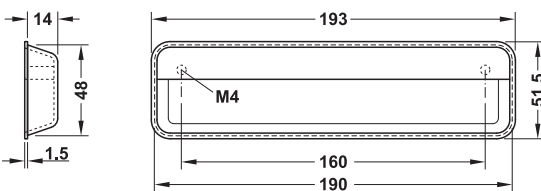

Oberfläche/Farbe	Artikel-Nr.
verchromt poliert	151.11.271
aluminiumfarben	151.11.971
edelstahlfarben	151.11.671
weiß, matt	151.11.771
schwarz, matt	151.11.972

Abpackung: 1 oder 5 Stück

Gewindeschrauben M4

► MB 1.470

DGH-M 2018, HDE-de, 06/18; Maßangaben unverbindlich. Konstruktionsänderungen vorbehalten.

1

Möbelgriffe Trend



Die Rückplatte des Artikels 151.05.210 kann passend zur Möbeloberfläche in jeder beliebigen Farbe lackiert werden.

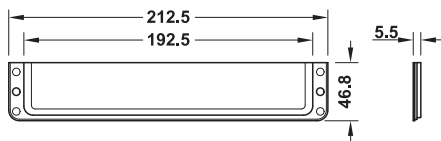
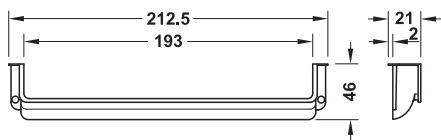
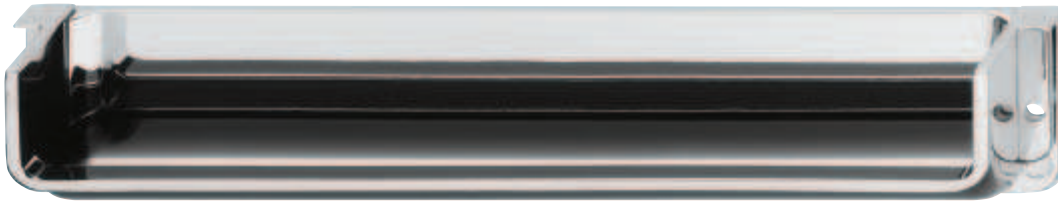
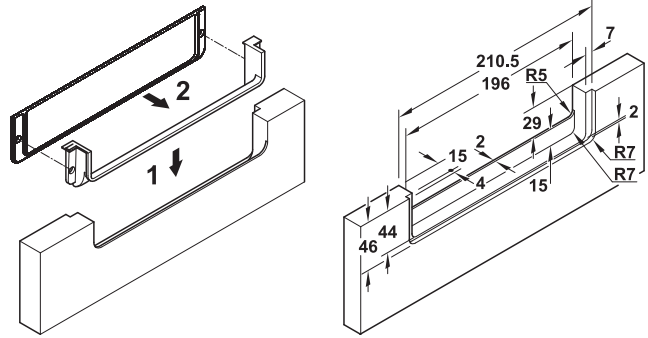

Oberfläche/Farbe	Artikel-Nr.
Muschel und Rückplatte: verchromt poliert	151.05.200
Muschel: verchromt poliert, Rückplatte: weiß	151.05.210
Muschel und Rückplatte: vernickelt gebürstet	151.05.600

Abpackung: 1 oder 25 Stück

Spanplattenschrauben Hospa Senkkopf Ø 4 mm ► MB 1.470

DGH-M 2018; HDE-de, 06/18; Maßangaben unverbindlich. Konstruktionsänderungen vorbehalten.

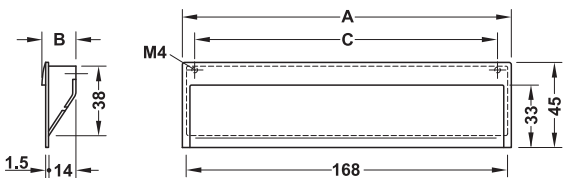

Oberfläche/Farbe	Maß A mm	Maß B mm	Maß C mm	Artikel-Nr.
vermessingt gebürstet	45	18	32	155.01.950
	173	18	160	155.01.960
vernickelt gebürstet	45	18	32	155.01.951
	173	18	160	155.01.961

Abpackung: 1 Stück

Gewindeschrauben M4

► MB 1.470

DGH-M 2018, HIDE-de, 06/18; Maßangaben unverbindlich. Konstruktionsänderungen vorbehalten.

06.09.2019  
ID 4629

1



Möbelgriffe Trend

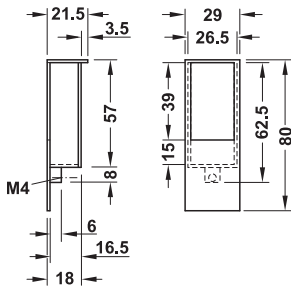

Oberfläche	Artikel-Nr.
verchromt poliert	152.13.200
aluminiumfarben	152.13.900

Abpackung: 1 oder 25 Stück

Gewindeschrauben M4

► MB 1.470

DGH-M 2018; HDE-de, 06/18; Maßangaben unverbindlich. Konstruktionsänderungen vorbehalten.



Modell H1360



Bei den Griffen 110.34.091, 110.34.094 und 110.34.096 wurden bewusst Gebrauchspuren eingearbeitet. Deshalb ist jeder Griff ein Unikat.



1



Möbelgriffe Trend

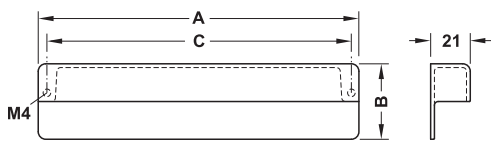

Oberfläche	Maß A mm	Maß B mm	Maß C mm	Artikel-Nr.
vernickelt gebürstet	42	40	32	110.34.691
	106	40	96	110.34.694
	170	40	160	110.34.696
eisenfarben Used Look	42	40	32	110.34.091
	106	40	96	110.34.094
	170	40	160	110.34.096

Abpackung: 1 oder 20 Stück

DGH-M 2018, HDE-de, 06/18; Maßangaben unverbindlich. Konstruktionsänderungen vorbehalten.

Gewindeschrauben M4

► MB 1.470

Modell H1765

1



Möbelgriffe Trend

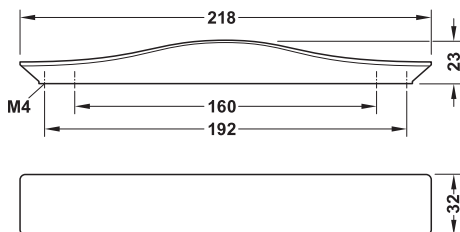

Oberfläche/Farbe	Artikel-Nr.
verchromt poliert	106.62.286
vernickelt schwarz poliert	106.62.386

Abpackung: 1 oder 5 Stück

Gewindeschrauben M4

► MB 1.470

DGH-M 2018; HDE-de, 06/18; Maßangaben unverbindlich. Konstruktionsänderungen vorbehalten.

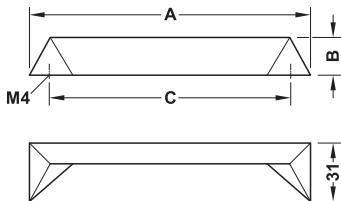

> Werkstoff: Zinkdruckguss

Oberfläche/Farbe	Maß A mm	Maß B mm	Maß C mm	Artikel-Nr.
schwarz, matt	149	20	128	113.97.510
vernickelt gebürstet				113.97.511
weiß, matt				113.97.512
verchromt poliert				113.97.513
verchromt matt				113.97.514
schwarz, matt	213	20	192	113.97.500
vernickelt gebürstet				113.97.501
weiß, matt				113.97.502
verchromt poliert				113.97.503
verchromt matt				113.97.504

Abpackung: 1 oder 25 Stück

Gewindeschrauben M4

► MB 1.470

1



Möbelgriffe Trend

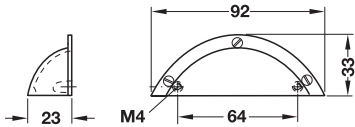

> Werkstoff: Zinkdruckguss

Oberfläche	Artikel-Nr.
vernickelt matt	166.11.600

Abpackung: 1 oder 25 Stück

Gewindeschrauben M4 ▶ MB 1.470

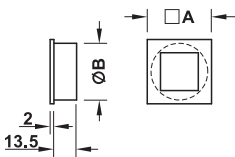
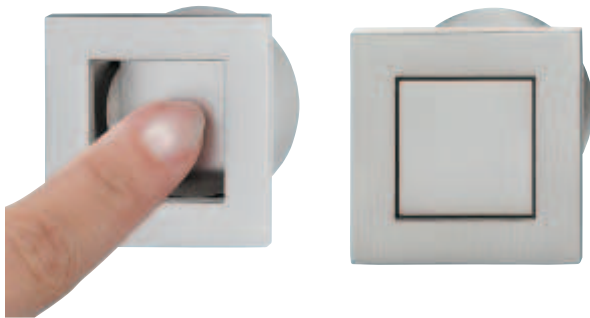

> Werkstoff: Zinkdruckguss  
> Oberfläche: edelstahlfarben  
> Montage: schraubenlose Befestigung zum Kleben

Maß A mm	Maß B mm	Artikel-Nr.
40	35	151.67.012

Abpackung: 1 oder 25 Stück

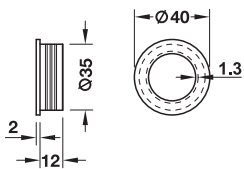
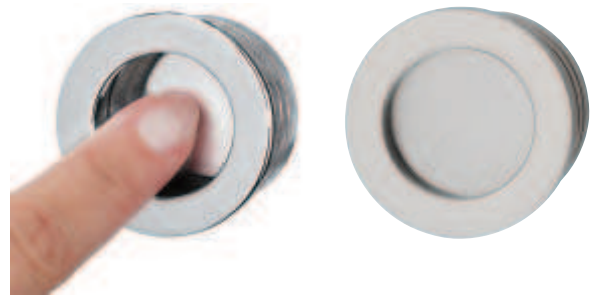

> Werkstoff: Messing  
> Montage: schraubenlose Befestigung mit Leimrillen

Oberfläche	Artikel-Nr.
vernickelt matt	151.98.600

Abpackung: 1 oder 50 Stück

DGH-M 2018; HDE-de, 06/18; Maßangaben unverbindlich. Konstruktionsänderungen vorbehalten.

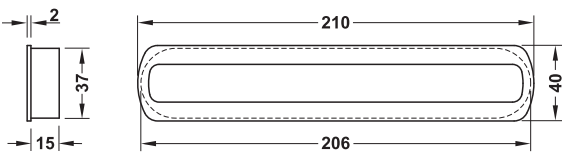

- > Oberfläche: natur
- > Montage: schraubenlose Befestigung zum Kleben

Werkstoff	Artikel-Nr.
Nussbaum	192.29.722
Eiche	192.29.422

Abpackung: 1 oder 25 Stück

DGH-M 2018, HIDE-de, 06/18; Maßangaben unverbindlich. Konstruktionsänderungen vorbehalten.

1

Möbelgriffe Trend

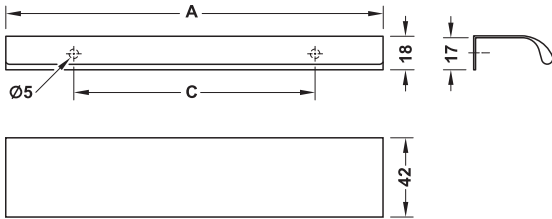

Oberfläche	Maß A mm	Maß C mm	Abpackung Stück	Artikel-Nr.
grau gebürstet	50	32	1 oder 25	126.45.110
	200	128	1 oder 25	126.45.111
	350	256	1 oder 25	126.45.112
	1100	1056	1 oder 15	126.45.113
schwarz gebürstet	50	32	1 oder 25	126.45.120
	200	128	1 oder 25	126.45.121
	350	256	1 oder 25	126.45.122
	1100	1056	1 oder 15	126.45.123

Spanplattenschrauben Hospa Senkkopf Ø 4,5 mm ► MB 1.470

DGH-M 2017, HDE-de, 01/17; Maßangaben unverbindlich. Konstruktionsänderungen vorbehalten.



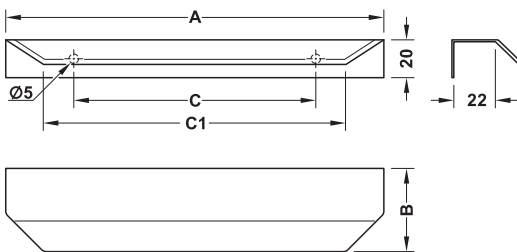
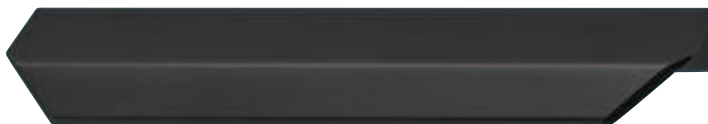
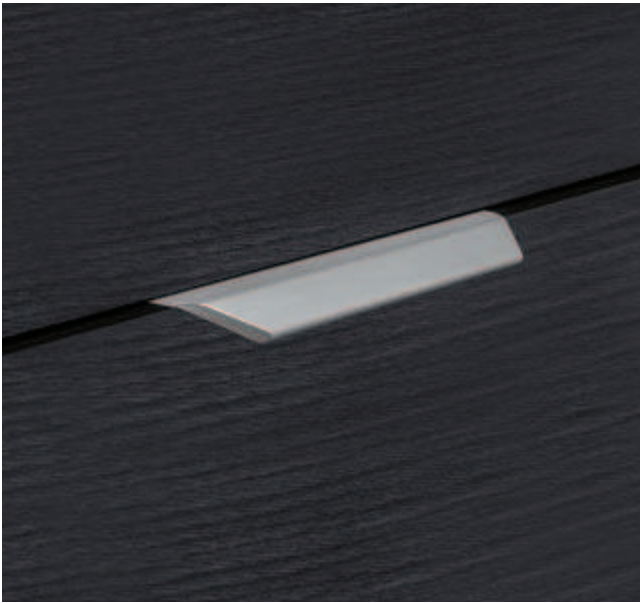

Oberfläche/Farbe	Maß A mm	Maß B mm	Maß C mm	Maß C1 mm	Artikel-Nr.
silberfarben, eloxiert	100	44	64	–	155.02.330
	200	44	128	–	155.02.331
	350	44	256	–	155.02.332
	1200	44	1120	384	155.02.333
edelstahlfarben, eloxiert	100	44	64	–	155.02.340
	200	44	128	–	155.02.341
	350	44	256	–	155.02.342
	1200	44	1120	384	155.02.343
vermessingt, eloxiert	100	44	64	–	155.02.350
	200	44	128	–	155.02.351
	350	44	256	–	155.02.352
	1200	44	1120	384	155.02.353
schwarz, eloxiert	100	44	64	–	155.02.320
	200	44	128	–	155.02.321
	350	44	256	–	155.02.322
	1200	44	1120	384	155.02.323

Abpackung: 1 oder 25 Stück

Spanplattenschrauben Hospa Senkkopf Ø 4,5 mm

► MB 1.470

DGH-M 2017, HDE-de, 01/17; Maßangaben unverbindlich. Konstruktionsänderungen vorbehalten.

06.09.2019  
ID 4629

1

Möbelgriffe Trend

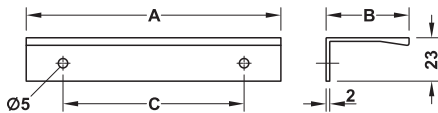

Oberfläche/ Farbe	Maß A mm	Maß B mm	Maß C mm	Abpackung Stück	Artikel-Nr.
schwarz matt, RAL 9017	40	44	25	1, 50 oder 500	155.02.370
	70	44	32	1, 50 oder 300	155.02.380
	135	44	96	1, 20 oder 160	155.02.390
	230	44	192	1, 20 oder 80	155.02.400
verchromt poliert	40	44	25	1, 50 oder 500	155.02.371
	70	44	32	1, 50 oder 300	155.02.381
	135	44	96	1, 20 oder 160	155.02.391
	230	44	192	1, 20 oder 80	155.02.401
silberfarben eloxiert	40	44	25	1, 50 oder 500	155.02.372
	70	44	32	1, 50 oder 300	155.02.382
	135	44	96	1, 20 oder 160	155.02.392
	230	44	192	1, 20 oder 80	155.02.402
dunkel vermessingt gebürstet	40	44	25	1, 50 oder 500	155.02.373
	70	44	32	1, 50 oder 300	155.02.383
	135	44	96	1, 20 oder 160	155.02.393
	230	44	192	1, 20 oder 80	155.02.403
schwarz eloxiert gebürstet	40	44	25	1, 50 oder 500	155.02.374
	70	44	32	1, 50 oder 300	155.02.384
	135	44	96	1, 20 oder 160	155.02.394
	230	44	192	1, 20 oder 80	155.02.404
bronzefarben dunkel geölt	40	44	25	1, 50 oder 500	155.02.375
	70	44	32	1, 50 oder 300	155.02.385
	135	44	96	1, 20 oder 160	155.02.395
	230	44	192	1, 20 oder 80	155.02.405
vermessingt gebürstet	40	44	25	1, 50 oder 500	155.02.376
	70	44	32	1, 50 oder 300	155.02.386
	135	44	96	1, 20 oder 160	155.02.396
	230	44	192	1, 20 oder 80	155.02.406

Spanplattenschrauben Hospa Senkkopf Ø 4,5 mm ► MB 1.470

DGH-M 2018; HDE-de, 06/18; Maßangaben unverbindlich. Konstruktionsänderungen vorbehalten.

**DIESE SEITE WURDE BEWUSST  
LEER GELASSEN**

**INTENTIONAL BLANK PAGE**

1



Möbelgriffe Trend

Modell H1535

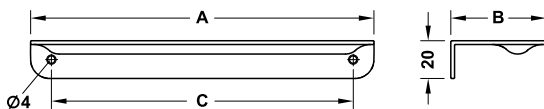

Oberfläche/Farbe	Maß A mm	Maß B mm	Maß C mm	Artikel-Nr.
silberfarben eloxiert	150	50	128	106.60.933
	182	50	160	106.60.934
	214	50	192	106.60.936
edelstahlfarben	150	50	128	106.60.033
	182	50	160	106.60.034
	214	50	192	106.60.036

Abpackung: 1 oder 20 Stück

Gewindeschrauben M4

► MB 1.470

DGH-M 2018; HDE-de, 06/18; Maßangaben unverbindlich. Konstruktionsänderungen vorbehalten.

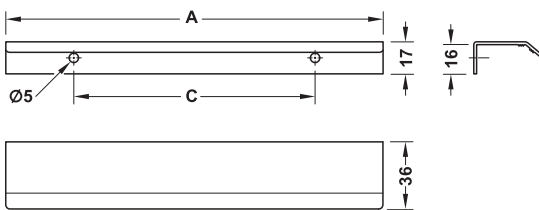

Oberfläche	Maß A mm	Maß C mm	Artikel-Nr.
edelstahlfarben	45	32	126.45.031
	200	128	126.45.755
weiß matt	45	32	126.45.751
	200	128	126.45.755
schwarz matt	45	32	126.45.351
	200	128	126.45.355
grau gebürstet	45	32	126.45.551
	200	128	126.45.555

Abpackung: 1 oder 25 Stück

DGH-M 2017, HDE-de, 01/17; Maßangaben unverbindlich. Konstruktionsänderungen vorbehalten.

Spanplattenschrauben Hospa Senkkopf Ø 4,5 mm ► MB 1.470

1

Möbelgriffe Trend

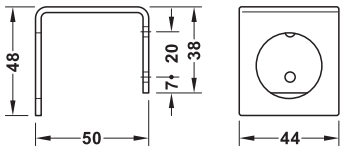

eckig

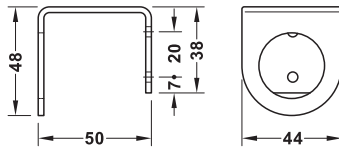

abgerundet

- > Designer: Bodil Kjaer
- > Oberfläche: matt gebürstet

Ausführung	Artikel-Nr.
eckig	102.04.130
abgerundet	102.04.131

Abpackung: 1 oder 10 Stück

Spanplattenschrauben Hospa Senkkopf Ø 3,5 mm ► MB 1.470

DGH-M 2018; HDE-de, 06/18; Maßangaben unverbindlich. Konstruktionsänderungen vorbehalten.



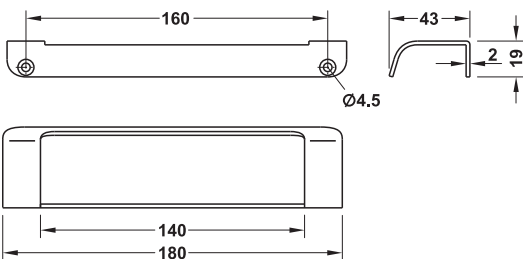

Oberfläche/Farbe	Artikel-Nr.
verchromt poliert	111.07.216
edelstahlfarben	111.07.016

Abpackung: 1 oder 25 Stück

Spanplattenschraube Hospa  $\varnothing 4,0$  mm

► MB 1.470

1



Möbelgriffe Trend



Elegante Griffleisten-Optik ohne aufwändiges Einnuten

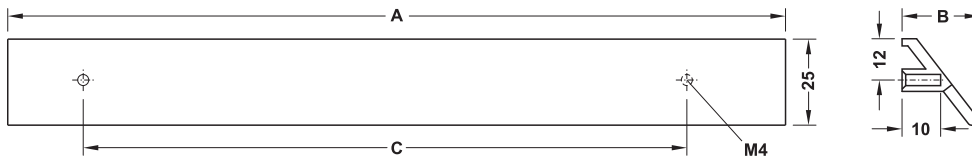

Oberfläche	Maß A mm	Maß B mm	Maß C mm	Artikel-Nr.
edelstahlfarben	56	20,5	32	110.35.031
	200	20,5	160	110.35.036

Abpackung: 1 oder 25 Stück

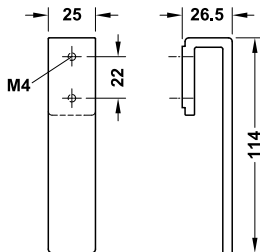

Oberfläche/Farbe	Artikel-Nr.
edelstahlfarben	110.24.011

Abpackung: 1 oder 25 Stück

Gewindeschrauben M4

► MB 1.470

DGH-M 2018; HDE-de, 06/18; Maßangaben unverbindlich. Konstruktionsänderungen vorbehalten.

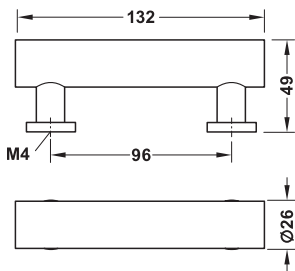

> Designer: Michael Graves

Oberfläche/Farbe	Artikel-Nr.
verchromt poliert	102.04.350

Abpackung: 1 oder 5 Stück

DGH-M 2018, HIDE-de, 06/18; Maßangaben unverbindlich. Konstruktionsänderungen vorbehalten.

passender Möbelknopf	► MB 1.121 C
Gewindeschrauben M4	► MB 1.470

Möbelgriffe Trend

**DIESE SEITE WURDE BEWUSST  
LEER GELASSEN**

**INTENTIONAL BLANK PAGE**

**Modell H1355**



1



Möbelgriffe Trend

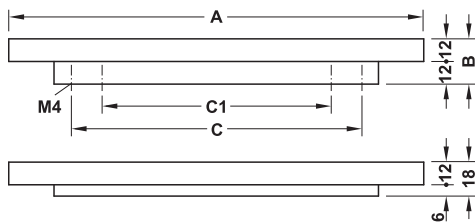

Oberfläche	Maß A mm	Maß B mm	Maß C mm	Maß C1 mm	Artikel-Nr.
verchromt	80	24	–	32	110.35.281
poliert	220	24	160	128	110.35.286
edelstahl- farben	80	24	–	32	110.35.681
	220	24	160	128	110.35.686

Abpackung: 1 oder 10 Stück

Gewindeschrauben M4

► MB 1.470

DGH-M 2018, HIDE-de, 06/18; Maßangaben unverbindlich. Konstruktionsänderungen vorbehalten.

1



Möbelgriffe Trend

**Modell H1540**

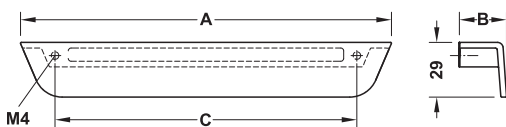

Oberfläche/Farbe	Maß A mm	Maß B mm	Maß C mm	Artikel-Nr.
silberfarben eloxiert	69	25	32	106.60.941
	197	25	160	106.60.944
edelstahlfarben	69	25	32	106.60.041
	197	25	160	106.60.044

Abpackung: 1 oder 20 Stück

**Modell H1545**

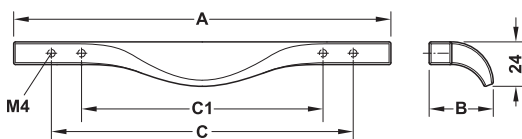

Oberfläche/Farbe	Maß A mm	Maß B mm	Maß C1 mm	Maß C mm	Artikel-Nr.
edelstahlfarben	200	34	128	160	106.60.023
	350	34	256	320	106.60.027

Abpackung: 1 oder 25 Stück

Gewindeschrauben M4

► MB 1.470

DGH-M 2018; HDE-de, 06/18; Maßangaben unverbindlich. Konstruktionsänderungen vorbehalten.



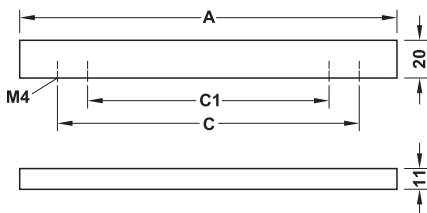
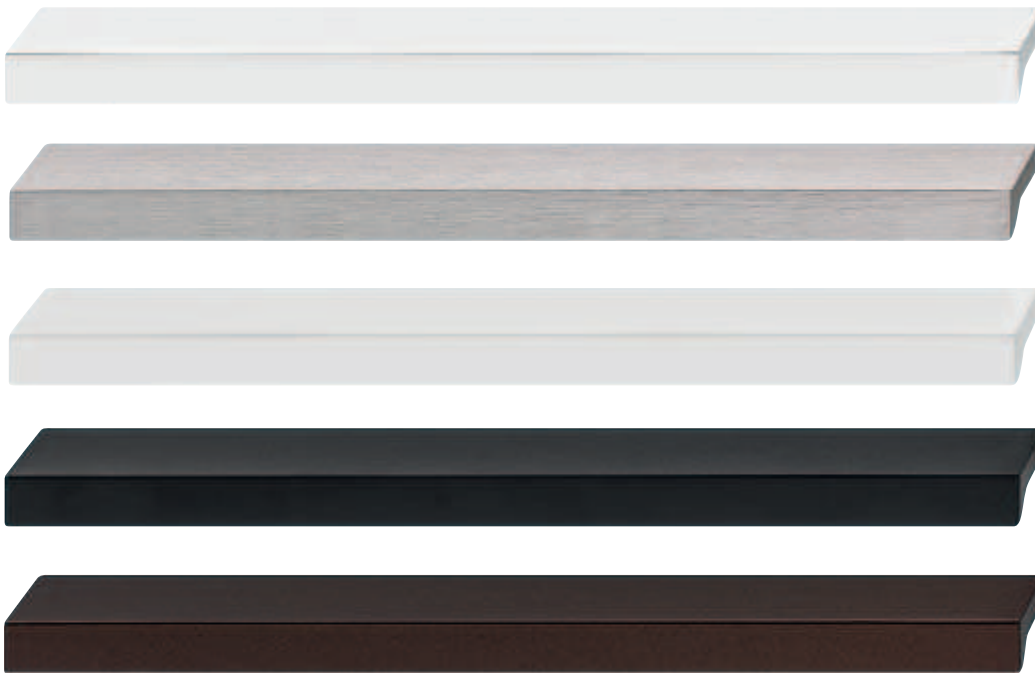

Oberfläche	Maß A mm	Maß C1 mm	Maß C mm	Artikel-Nr.
verchromt poliert	200	128	160	108.66.230
	400	256	320	108.66.231
	500	320	416	108.66.232
	600	480	512	108.66.233
	900	640	320	108.66.234
edelstahlfarben	200	128	160	108.66.040
	300	–	192	108.66.041
	400	256	320	108.66.042
	500	320	416	108.66.051
	600	480	512	108.66.046
	900	640	320	108.66.047
weiß matt	200	128	160	108.66.030
	500	320	416	108.66.043
	900	640	320	108.66.048
schwarz matt	200	128	160	108.66.330
	500	320	416	108.66.044
	900	640	320	108.66.049
braun metallic	600	480	512	108.66.045
	900	640	320	108.66.050

Abpackung: 1 oder 25 Stück

Gewindeschrauben M4

► MB 1.470

DGH-M 2017, HDE-de, 01/17; Maßangaben unverbindlich. Konstruktionsänderungen vorbehalten.

Möbelgriffe Trend

1

Möbelgriffe Trend

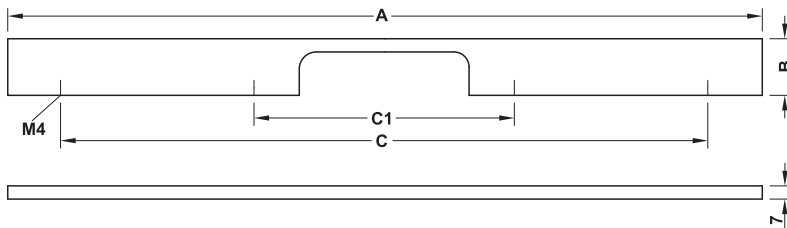

**Hinweis**

Ab einer Länge von 400 mm sind 4 Bohrungen zur Befestigung notwendig.

Oberfläche/ Farbe	Maß A mm	Maß B mm	Maß C mm	Maß C1 mm	Abpackung Stück	Artikel-Nr.
schwarz matt, RAL 9017	300	30	224	–	1 oder 30	155.01.830
	350	30	256	–	1 oder 25	155.01.831
	400	30	320	160	1 oder 35	155.01.832
	500	30	384	160	1 oder 35	155.01.833
	700	30	560	160	1 oder 20	155.01.834
	800	30	640	160	1 oder 20	155.01.835
verchromt poliert	300	30	224	–	1 oder 30	155.01.840
	350	30	256	–	1 oder 25	155.01.841
	400	30	320	160	1 oder 35	155.01.842
	500	30	384	160	1 oder 35	155.01.843
	700	30	560	160	1 oder 20	155.01.844
	800	30	640	160	1 oder 20	155.01.845

Gewindeschrauben M4

► MB 1.470

DGH-M 2018; HDE-de, 06/18; Maßangaben unverbindlich. Konstruktionsänderungen vorbehalten.

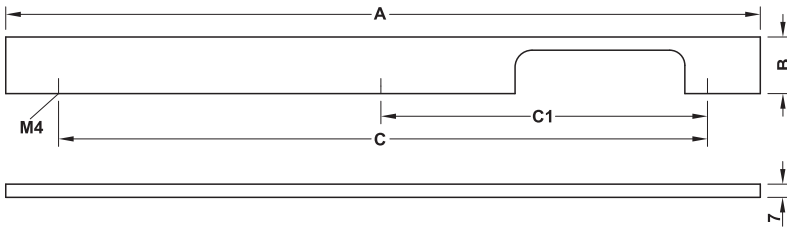

**Hinweis**

Ab einer Länge von 400 mm sind 4 Bohrungen zur Befestigung notwendig.

Oberfläche/ Farbe	Maß A mm	Maß B mm	Maß C mm	Maß C1 mm	Abpackung Stück	Artikel-Nr.
schwarz matt, RAL 9017	300	30	256	–	1 oder 30	155.01.850
	350	30	288	–	1 oder 25	155.01.851
	400	30	352	160	1 oder 35	155.01.852
	500	30	448	160	1 oder 35	155.01.853
	700	30	640	160	1 oder 20	155.01.854
	800	30	736	160	1 oder 20	155.01.855
verchromt poliert	300	30	256	–	1 oder 30	155.01.860
	350	30	288	–	1 oder 25	155.01.861
	400	30	352	160	1 oder 35	155.01.862
	500	30	448	160	1 oder 35	155.01.863
	700	30	640	160	1 oder 20	155.01.864
	800	30	736	160	1 oder 20	155.01.865

Gewindeschrauben M4

► MB 1.470

DGH-M 2018, HIDE-de, 06/18; Maßangaben unverbindlich. Konstruktionsänderungen vorbehalten.

06.09.2019  
ID 4629

1

Möbelgriffe Trend

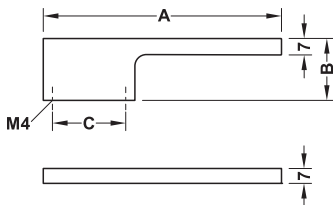

Oberfläche/Farbe	Maß A mm	Maß B mm	Maß C mm	Artikel-Nr.
schwarz matt	105	30	32	155.01.870
verchromt poliert	105	30	32	155.01.871

Abpackung: 1 oder 35 Stück

Gewindeschrauben M4

► MB 1.470

DGH-M 2018; HDE-de, 06/18; Maßangaben unverbindlich. Konstruktionsänderungen vorbehalten.

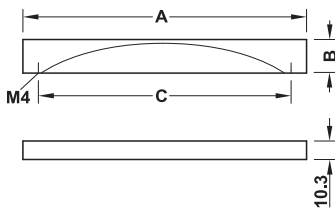

Oberfläche/ Farbe	Maß A mm	Maß B mm	Maß C mm	Abpackung Stück	Artikel-Nr.
verchromt matt	83	18	64	1 oder 25	155.01.990
	147	18	128	1 oder 20	155.02.000
	184	18	160	1 oder 20	155.02.010
vernickelt matt	83	18	64	1 oder 25	155.01.991
	147	18	128	1 oder 20	155.02.001
	184	18	160	1 oder 20	155.02.011
verchromt poliert	83	18	64	1 oder 25	155.01.992
	147	18	128	1 oder 20	155.02.002
	184	18	160	1 oder 20	155.02.012
vermessingt gebürstet	83	18	64	1 oder 25	155.01.993
	147	18	128	1 oder 20	155.02.003
	184	18	160	1 oder 20	155.02.013

DGH-M 2018, HDE-de, 06/18; Maßangaben unverbindlich. Konstruktionsänderungen vorbehalten.

Gewindeschrauben M4

► MB 1.470

Möbelgriffe Trend

06.09.2019  
 ID 4629

**DIESE SEITE WURDE BEWUSST  
LEER GELASSEN**

**INTENTIONAL BLANK PAGE**



Modell H1315

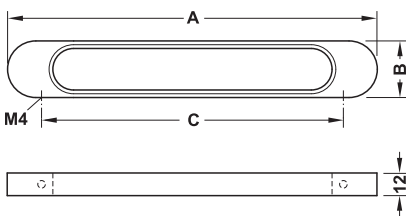

Oberfläche/Farbe	Maß A mm	Maß B mm	Maß C mm	Artikel-Nr.
verchromt poliert	196	30	160	110.34.216
	228	30	192	110.34.217
vernickelt gebürstet	196	30	160	110.34.616
	228	30	192	110.34.617
vernickelt schwarz poliert	196	30	160	110.34.346
	228	30	192	110.34.347

Abpackung: 1 oder 10 Stück

Gewindeschrauben M4

► MB 1.470

1



Möbelgriffe Trend

Modell H1320

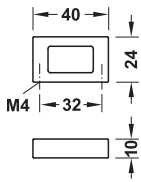

Oberfläche	Artikel-Nr.
verchromt poliert	110.34.271
vernickelt gebürstet	110.34.671
titanfarben lackiert	110.34.071

Abpackung: 1 oder 20 Stück

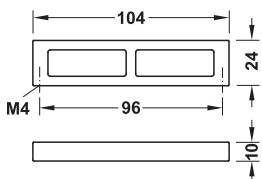

Oberfläche	Artikel-Nr.
verchromt poliert	110.34.274
vernickelt gebürstet	110.34.674
titanfarben lackiert	110.34.074

Abpackung: 1 oder 25 Stück

Gewindeschrauben M4

► MB 1.470

DGH-M 2018; HDE-de, 06/18; Maßangaben unverbindlich. Konstruktionsänderungen vorbehalten.

Modell H1320

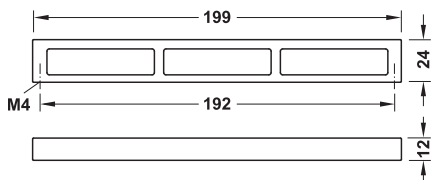
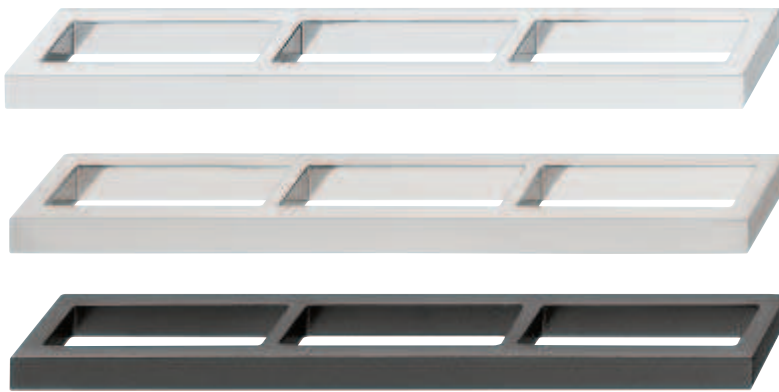

Oberfläche	Artikel-Nr.
verchromt poliert	110.34.277
vernickelt gebürstet	110.34.677
titanfarben lackiert	110.34.077

Abpackung: 1 oder 10 Stück

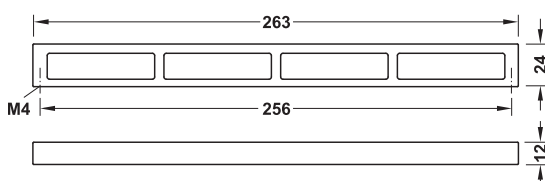

Oberfläche	Artikel-Nr.
verchromt poliert	110.34.279
vernickelt gebürstet	110.34.679
titanfarben lackiert	110.34.079

Abpackung: 1 oder 10 Stück

Gewindeschrauben M4

► MB 1.470

DGH-M 2018, HIDE-de, 06/18; Maßangaben unverbindlich. Konstruktionsänderungen vorbehalten.

1  
 GAEB  
 CAD  
 Möbelgriffe Trend

1



Möbelgriffe Trend

Modell H1520



Beim Griff 106.61.464 wurden bewusst Gebrauchsspuren eingearbeitet. Dadurch ist jeder Griff ein Unikat. 

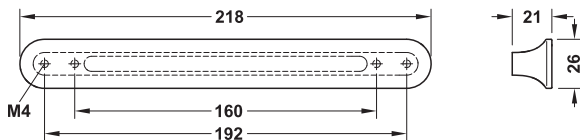

Oberfläche/Farbe	Artikel-Nr.
weiß, matt lackiert	106.61.764
titanfarben, lackiert	106.61.964
bleifarben	106.61.464
verkupfert antik	106.61.164

Abpackung: 1 oder 10 Stück

Gewindeschrauben M4 ▶ MB 1.470

DGH-M 2018; HDE-de, 06/18; Maßangaben unverbindlich. Konstruktionsänderungen vorbehalten.

**Modell H1550**

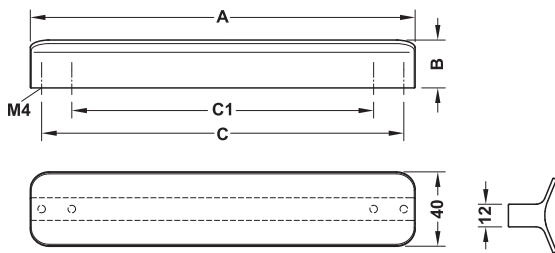

> Oberfläche: vernickelt gebürstet

Maß A mm	Maß B mm	Maß C1 mm	Maß C mm	Abpackung Stück	Artikel-Nr.
44	25	–	32	1 oder 10	106.61.071
204	25	160	192	1 oder 5	106.61.074

DGH-M 2018, HIDE-de, 06/18; Maßangaben unverbindlich. Konstruktionsänderungen vorbehalten.

Gewindeschrauben M4

► MB 1.470

1



Möbelgriffe Trend



1



Möbelgriffe Trend

Modell H1745

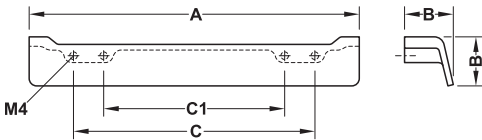

Oberfläche/ Farbe	Maß A mm	Maß B mm	Maß C mm	Maß C1 mm	Artikel-Nr.
verchromt	111	26	–	64	106.62.243
poliert	175	26	128	96	106.62.244
vernickelt matt	111	26	–	64	106.62.643
	175	26	128	96	106.62.644
vernickelt schwarz poliert	111	26	–	64	106.62.343
	175	26	128	96	106.62.344

Abpackung: 1 oder 10 Stück

Gewindeschrauben M4

► MB 1.470

DGH-M 2018; HDE-de, 06/18; Maßangaben unverbindlich. Konstruktionsänderungen vorbehalten.



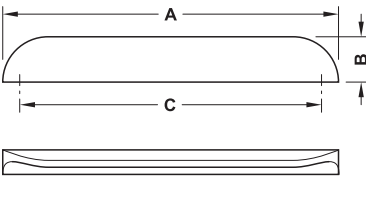

Oberfläche	Maß A mm	Maß B mm	Maß C mm	Artikel-Nr.
verchromt poliert	50	24	32	132.15.240
	178	24	160	132.15.250
vernickelt gebürstet	50	24	32	132.15.241
	178	24	160	132.15.251
verkupfert gebürstet	50	24	32	126.45.060
	178	24	160	126.45.061
vermessingt gebürstet	50	24	32	126.45.062
	178	24	160	126.45.063

Abpackung: 1 oder 25 Stück

Gewindeschrauben M4

► MB 1.470

DGH-M 2018, HIDE-de, 06/18; Maßangaben unverbindlich. Konstruktionsänderungen vorbehalten.

1



Möbelgriffe Trend

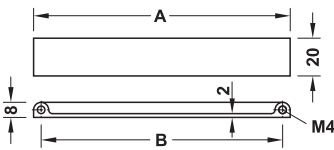

Oberfläche/Farbe	Maß A mm	Maß B mm	Artikel-Nr.
verchromt poliert	136	128	111.44.235
	264	256	111.44.238
	328	320	111.44.239
edelstahlfarben	136	128	111.44.035
	264	256	111.44.038
	328	320	111.44.039

Abpackung: 1 oder 25 Stück

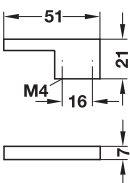

Oberfläche	Artikel-Nr.
verchromt poliert	110.26.201
aluminiumfarben	110.26.901
vernickelt matt	110.26.601

Abpackung: 1 oder 25 Stück

Gewindeschrauben M4

► MB 1.470

DGH-M 2018; HDE-de, 06/18; Maßangaben unverbindlich. Konstruktionsänderungen vorbehalten.

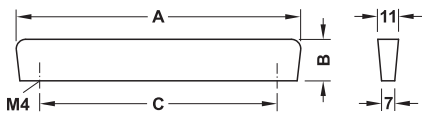

Oberfläche	Maß A mm	Maß B mm	Maß C mm	Artikel-Nr.
oiled	55	22	32	111.44.191
bronze	151	22	128	111.44.195

Abpackung: 1 oder 25 Stück

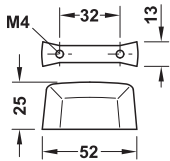

Oberfläche	Artikel-Nr.
verchromt poliert	111.44.241
verchromt matt	111.44.441
edelstahlfarben	111.44.041

Abpackung: 1 oder 25 Stück

DGH-M 2018, HIDE-de, 06/18; Maßangaben unverbindlich. Konstruktionsänderungen vorbehalten.

Gewindeschrauben M4

► MB 1.470

1

Möbelgriffe Trend

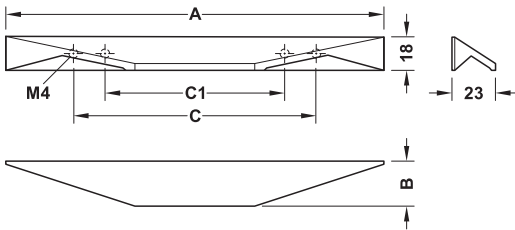

Oberfläche/Farbe	Maß A mm	Maß B mm	Maß C mm	Maß C1 mm	Artikel-Nr.
edelstahlfarben, eloxiert	200	23	128	96	110.46.084
edelstahlfarben, eloxiert	400	23	320	192	110.46.087
schwarz, matt, eloxiert	200	23	128	96	155.02.360
schwarz, matt, eloxiert	400	23	320	192	155.02.361

Abpackung: 1 oder 25 Stück

Gewindeschrauben M4

► MB 1.470

DGH-M 2018; HDE-de, 06/18; Maßangaben unverbindlich. Konstruktionsänderungen vorbehalten.

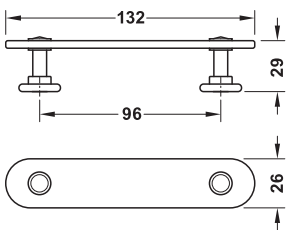

- > Werkstoff: Griff: Leder, Sockel: Stahl
- > Designer: Michael Graves

Oberfläche/Farbe	Artikel-Nr.
Griff: braun, Sockel: verchromt poliert	102.04.370
Griff: naturbraun, Sockel: verchromt poliert	102.04.371
Griff: anthrazitfarben, Sockel: verchromt poliert	102.04.372

Abpackung: 1 oder 5 Stück

passender Möbelknopf	► MB 1.130 A
Gewindeschrauben M4	► MB 1.470

1



Möbelgriffe Trend

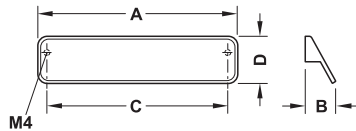

> Werkstoff: Griff: Zinkdruckguss, Einlage: Leder

Oberfläche	Maß A mm	Maß B mm	Maß C mm	Maß D mm	Artikel-Nr.
Griff: vernickelt poliert, Einlage: dunkelbraun	170	30	160	17	103.83.713

Abpackung: 1 oder 25 Stück

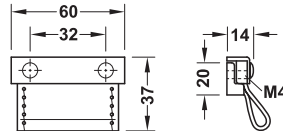

> Werkstoff: Griff: Leder, Sockel: Zinkdruckguss

Oberfläche	Artikel-Nr.
Griff: dunkelbraun Sockel: edelstahlfarben	110.76.030

Abpackung: 1 oder 20 Stück

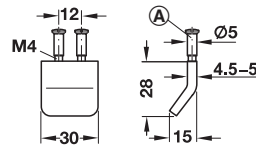

Farbe	Artikel-Nr.
schwarz	105.95.350

Abpackung: 1 oder 25 Stück

Ⓐ Hülse Ø 5 mm

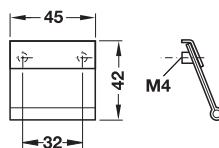

> Werkstoff: Griff: Leder, Sockel: Zinkdruckguss

Oberfläche/Farbe	Artikel-Nr.
Griff: hellbraun, Sockel: verchromt poliert	110.81.150

Abpackung: 1 oder 50 Stück

Gewindeschrauben M4

► MB 1.470

DGH-M 2018; HDE-de, 06/18; Maßangaben unverbindlich. Konstruktionsänderungen vorbehalten.





Dieser Möbelgriff kann auch als Klapphaken verwendet werden. Beim Aufklappen zeigt der Haken nach oben. 

1



Möbelgriffe Trend

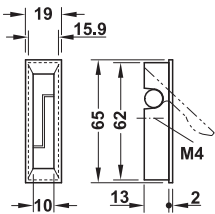
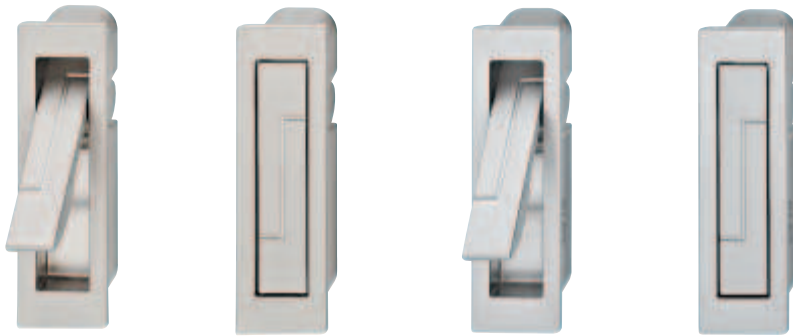

Oberfläche	Artikel-Nr.
verchromt matt	844.33.400
vernickelt matt	844.33.600

Abpackung: 1 oder 10 Stück

Möbelgriff als Klapphaken ▶ MB 1.447

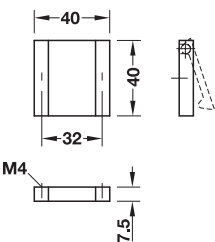

Oberfläche	Artikel-Nr.
verchromt matt	161.02.400
vernickelt matt	161.02.600

Abpackung: 1 oder 10 Stück

Gewindeschrauben M4 ▶ MB 1.470

DGH-M 2018, HIDE-de, 06/18; Maßangaben unverbindlich. Konstruktionsänderungen vorbehalten.

1

GAEB

CAD

Möbelknöpfe Trend

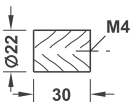
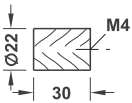

> Werkstoff: Edelstahl Güte 1.4571  
> Ausführung: Baustahl-Optik

Oberfläche	Artikel-Nr.
matt gebürstet	117.64.000

Abpackung: 1 oder 10 Stück

Bogengriff Edelstahl in Baustahl-Optik	► MB 1.42
Bügelgriff Edelstahl in Baustahl-Optik	► MB 1.36
Garderobenbügel Edelstahl in Baustahl-Optik	► MB 1.368
Garderobenhaken Edelstahl in Baustahl-Optik	► MB 1.411

> Werkstoff: Stahl  
> Ausführung: in Baustahl-Optik

Oberfläche	Artikel-Nr.
roh lackiert, Used Look	117.30.300

Abpackung: 1 oder 10 Stück

Bügelgriff Stahl in Baustahl-Optik	► MB 1.42
Bogengriff Stahl in Baustahl-Optik	► MB 1.36
Garderobenbügel Stahl in Baustahl-Optik	► MB 1.368
Garderobenhaken Stahl in Baustahl-Optik	► MB 1.411
Gewindeschrauben M4	► MB 1.470

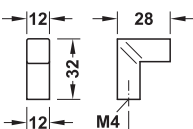
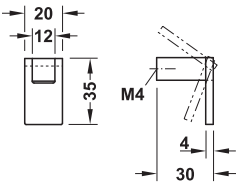

> Werkstoff: Edelstahl, Güte 1.4305  
> Ausführung: mit Verdrehstift

Oberfläche	Artikel-Nr.
matt gebürstet	112.02.020

Abpackung: 1 oder 10 Stück

> Werkstoff: Stahl

Oberfläche	Artikel-Nr.
matt lackiert, Used Look	112.02.340

Abpackung: 1 oder 10 Stück

passender Garderobenhaken ▶ MB 1.435

passender Möbelgriff ▶ MB 1.44

Gewindeschrauben M4

▶ MB 1.470

1

Möbelknöpfe Trend

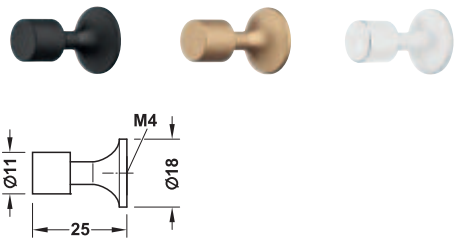

> Designer: Paul McCobb

Oberfläche/Farbe	Artikel-Nr.
schwarz	102.04.190
goldfarben	102.04.191
verchromt poliert	102.04.192

Abpackung: 1 oder 10 Stück

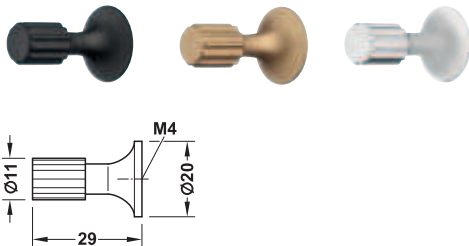

> Designer: Paul McCobb

Oberfläche/Farbe	Artikel-Nr.
schwarz	102.04.200
goldfarben	102.04.201
verchromt poliert	102.04.202

Abpackung: 1 oder 10 Stück

Gewindeschrauben M4

► MB 1.470

DGH-M 2017, HDE-de, 01/17; Maßangaben unverbindlich. Konstruktionsänderungen vorbehalten.

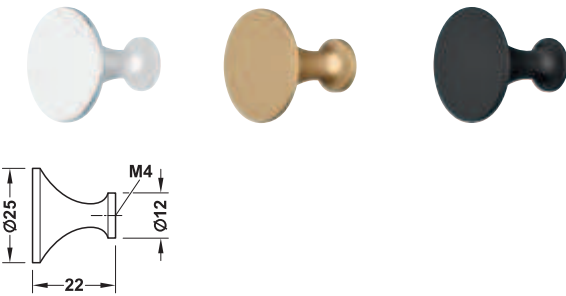

> Designer: Paul McCobb

Oberfläche/Farbe	Artikel-Nr.
verchromt poliert	102.04.212
goldfarben	102.04.211
schwarz	102.04.210

Abpackung: 1 oder 10 Stück

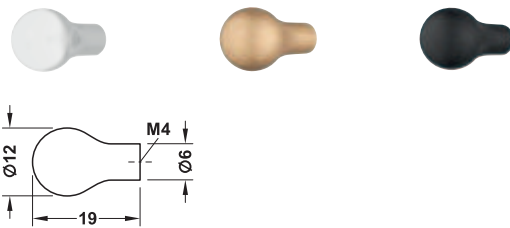

> Designer: Paul McCobb

Oberfläche/Farbe	Artikel-Nr.
verchromt poliert	102.04.222
goldfarben	102.04.221
schwarz	102.04.220

Abpackung: 1 oder 10 Stück

DGH-M 2017, HIDE-de, 01/17; Maßangaben unverbindlich. Konstruktionsänderungen vorbehalten.

Gewindeschrauben M4

► MB 1.470

24.02.2020  
ID 4767



1

Möbelknöpfe Trend

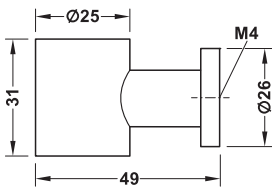

> Designer: Michael Graves

Oberfläche/Farbe	Artikel-Nr.
verchromt poliert	102.04.340

Abpackung: 1 oder 5 Stück

passender Möbelgriff	► MB 1.106 A
Gewindeschrauben M4	► MB 1.470



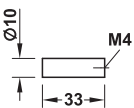
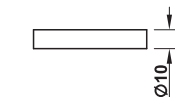
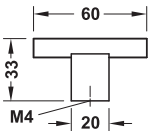
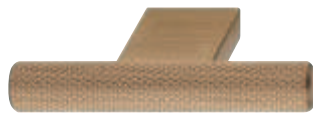
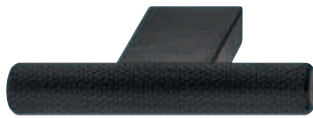
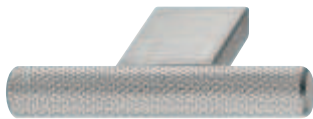

Oberfläche	Artikel-Nr.
edelstahlfarben	132.19.105
schwarz gebürstet	132.19.106
messingfarben gebürstet	132.19.107

Abpackung: 1 oder 25 Stück

Oberfläche	Artikel-Nr.
edelstahlfarben	132.19.100
schwarz gebürstet	132.19.101
messingfarben gebürstet	132.19.102

Abpackung: 1 oder 25 Stück

passender Möbelgriff	► MB 1.77 A
Gewindeschrauben M4	► MB 1.470

1

Möbelknöpfe Trend

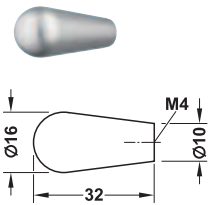

> Designer: Jasper Morrison

Oberfläche/Farbe	Artikel-Nr.
silberfarben eloxiert	102.04.390
schwarz eloxiert	102.04.391
goldfarben eloxiert	102.04.392

Abpackung: 1 oder 10 Stück

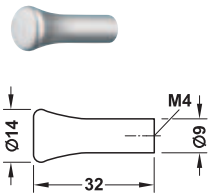

> Designer: Jasper Morrison

Oberfläche/Farbe	Artikel-Nr.
silberfarben eloxiert	102.04.400
schwarz eloxiert	102.04.401
goldfarben eloxiert	102.04.402

Abpackung: 1 oder 10 Stück

Gewindeschrauben M4

► MB 1.470

DGH-M 2018; HDE-de, 06/18; Maßangaben unverbindlich. Konstruktionsänderungen vorbehalten.

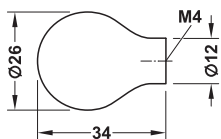
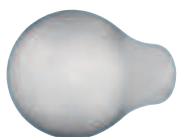
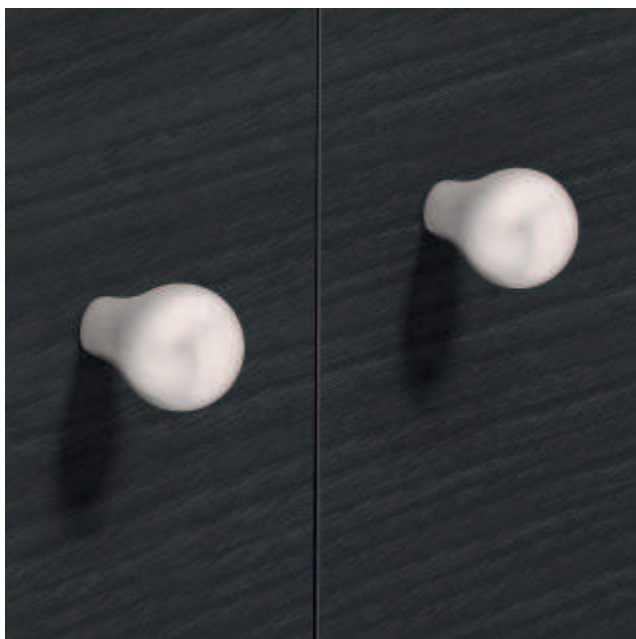

> Designer: Jasper Morrison

Oberfläche/Farbe	Artikel-Nr.
silberfarben eloxiert	102.04.410
schwarz eloxiert	102.04.411
goldfarben eloxiert	102.04.412

Abpackung: 1 oder 10 Stück

1

Möbelknöpfe Trend

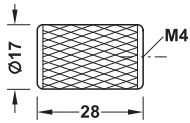
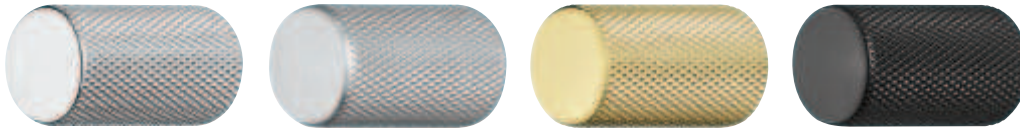

Oberfläche	Artikel-Nr.
verchromt poliert	132.15.230
edelstahlfarben	132.15.630
vermessingt gebürstet	132.19.210
schwarz matt	132.19.211

Abpackung: 1 oder 25 Stück

Gewindeschrauben M4

► MB 1.470

DGH-M 2018; HDE-de, 06/18; Maßangaben unverbindlich. Konstruktionsänderungen vorbehalten.

Häfele Design Modell H1940



1

Möbelknöpfe Trend

Möbelknöpfe passend zu den Eckknoten des Aluminium-Regalsystems.

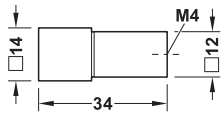

Oberfläche/Farbe	Artikel-Nr.
vernickelt gebürstet	106.70.071
schwarz, eloxiert	106.70.072
grau eloxiert	106.70.073
schwarz rau matt	106.70.074

Abpackung: 1 oder 100 Stück

Häfele Design Modell H1945

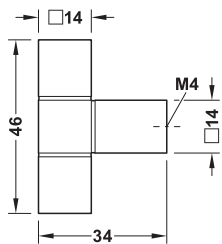
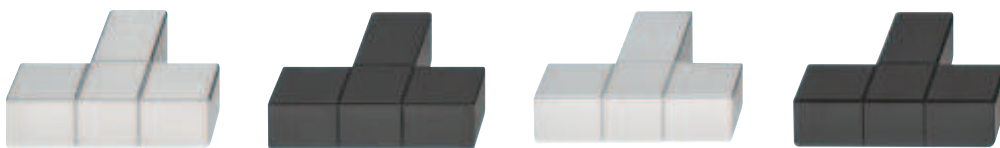

Oberfläche/Farbe	Artikel-Nr.
vernickelt gebürstet	106.70.081
schwarz, eloxiert	106.70.082
grau eloxiert	106.70.083
schwarz rau matt	106.70.084

Abpackung: 1 oder 100 Stück

passend zu Regalsystem	► MB 8.69 A
passender Möbelgriff	► MB 1.46 A
Gewindeschrauben M4	► MB 1.470

DGH-M 2018, HIDE-de, 06/18; Maßangaben unverbindlich. Konstruktionsänderungen vorbehalten.

29.07.2019  
ID 4588



1

Möbelknöpfe Trend

Häfele Design Modell H1960

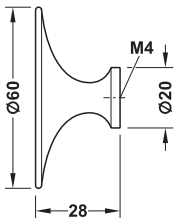

Oberfläche/Farbe	Artikel-Nr.
verchromt poliert	106.69.500
vermessingt gebürstet	106.69.502
schwarz, RAL 9017, matt	106.69.501

Abpackung: 1, 10 oder 100 Stück

Gewindeschrauben M4

► MB 1.470

DGH-M 2018; HDE-de, 06/18; Maßangaben unverbindlich. Konstruktionsänderungen vorbehalten.



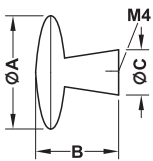

Oberfläche/Farbe	Maß A mm	Maß B mm	Maß C mm	Artikel-Nr.
verchromt poliert	30	22	12	155.02.240
vernickelt gebürstet	30	22	12	155.02.241
vermessingt gebürstet	30	22	12	155.02.242
schwarz matt, RAL 9017	30	22	12	155.02.243

Abpackung: 1, 50 oder 200 Stück

1

Möbelknöpfe Trend

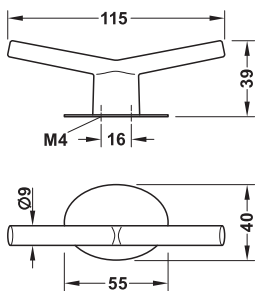

> Designer: Jens Risom

Oberfläche/Farbe	Artikel-Nr.
Griff: schwarz matt, Rückplatte: vermessingt gebürstet	102.04.110
Griff: verchromt poliert, Rückplatte: verchromt poliert	102.04.111
Griff: verchromt matt, Rückplatte: schwarz matt	102.04.112

Abpackung: 1 oder 5 Stück

Gewindeschrauben M4

► MB 1.470

DGH-M 2018; HDE-de, 06/18; Maßangaben unverbindlich. Konstruktionsänderungen vorbehalten.

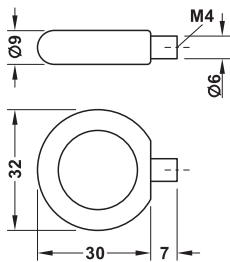
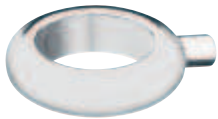

> Designer: Paul McCobb

Oberfläche/Farbe	Artikel-Nr.
verchromt poliert	102.04.180
schwarz	102.04.181
goldfarben	102.04.182

Abpackung: 1 oder 10 Stück

DGH-M 2018, HIDE-de, 06/18; Maßangaben unverbindlich. Konstruktionsänderungen vorbehalten.

Gewindeschrauben M4

► MB 1.470

24.02.2020  
ID 4767

**DIESE SEITE WURDE BEWUSST  
LEER GELASSEN**

**INTENTIONAL BLANK PAGE**

Modell H1340



Beim Möbelknopf 110.35.040 wurden bewusst Gebrauchsspuren eingearbeitet. Dadurch ist jeder Möbelknopf ein Unikat.



1



Möbelknöpfe Trend

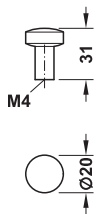

Oberfläche/Farbe	Artikel-Nr.
verchromt poliert	110.35.271
vernickelt gebürstet	110.35.671
weiß, RAL 9016, matt, lackiert	110.35.771
weißaluminium, lackiert	110.35.640
schwarz, RAL 9017, matt, lackiert	110.35.371
vernickelt schwarz poliert	110.35.340
eisenfarben, Used Look	110.35.040

Abpackung: 1 oder 25 Stück

DGH-M 2018, HIDE-de, 06/18; Maßangaben unverbindlich. Konstruktionsänderungen vorbehalten.

Gewindeschrauben M4

► MB 1.470

1



Möbelknöpfe Trend

Modell H1725

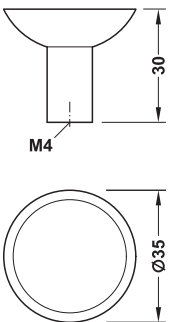

Oberfläche/Farbe	Artikel-Nr.
verzinkt antik	106.65.150
silberfarben, matt	106.65.650
rosésilberfarben	106.65.750
anthrazitfarben	106.65.450
schwarz, matt	106.65.350

Abpackung: 1 oder 50 Stück

passende Möbelgriffe	► MB 1.58
Gewindeschrauben M4	► MB 1.470

DGH-M 2018; HDE-de, 06/18; Maßangaben unverbindlich. Konstruktionsänderungen vorbehalten.



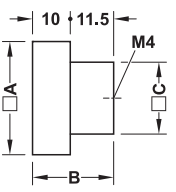

Oberfläche/Farbe	Maß A mm	Maß B mm	Maß C mm	Artikel-Nr.
verzinkt antik	30	21,5	18	155.01.780
bronzefarben geölt gebürstet	30	21,5	18	155.01.782
silberfarben, antik	30	21,5	18	155.01.783
verchromt poliert	30	21,5	18	155.01.784
vermessingt gebürstet	30	21,5	18	155.01.785

Abpackung: 1 Stück

passende Möbelgriffe ▶ MB 1.69 A

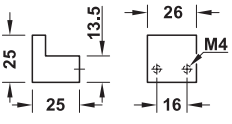
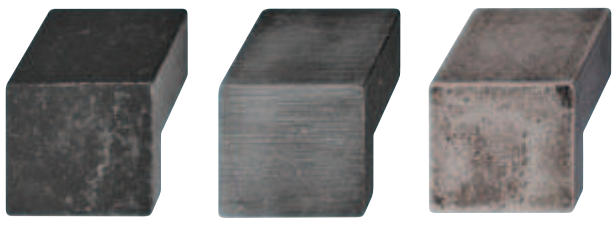

Oberfläche/Farbe	Artikel-Nr.
eisenfarben, Used Look	131.10.380
eisenfarben, Fläche aufgehellt, Used Look	131.10.381
vernickelt antik, Used Look	131.10.382

Abpackung: 1 Stück

passende Möbelgriffe ▶ MB 1.69  
Gewindeschrauben M4 ▶ MB 1.470

DGH-M 2018, HIDE-de, 06/18; Maßangaben unverbindlich. Konstruktionsänderungen vorbehalten.

1



MöbelknöpfeTrend

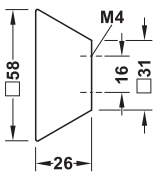
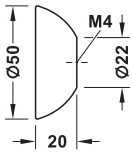

Werkstoff	Oberfläche	Artikel-Nr.
Eiche	weiß lackiert	196.45.711
Buche		196.45.710
Eiche	schwarz lackiert	191.67.125

Abpackung: 1 oder 25 Stück

Der Griff 196.45.721 kann in jeder beliebigen Farbe lackiert werden.



> Lochabstand: 16 mm

Werkstoff	Oberfläche	Artikel-Nr.
Eiche	weiß lackiert	196.45.721
	natur	196.45.421

Abpackung: 1 oder 25 Stück

Gewindeschrauben M4

► MB 1.470

DGH-M 2018; HDE-de, 06/18; Maßangaben unverbindlich. Konstruktionsänderungen vorbehalten.

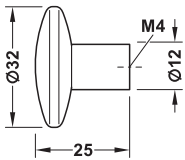
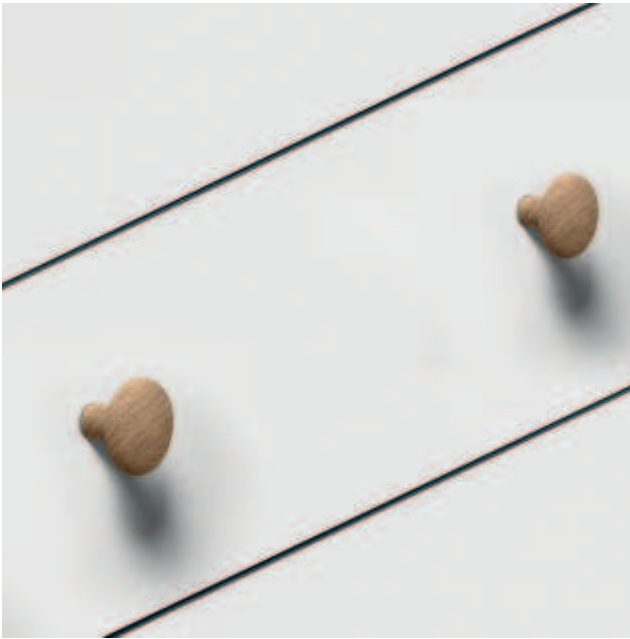

Werkstoff	Oberfläche	Artikel-Nr.
Eiche	natur lackiert	191.67.121
Esche	schwarz gebeizt	191.67.120

Abpackung: 1 oder 25 Stück

Möbelknöpfe, Holz

DGH-M 2018, HIDE-de, 06/18; Maßangaben unverbindlich. Konstruktionsänderungen vorbehalten.

passende Möbelgriffe	► MB 1.74 B
Gewindeschrauben M4	► MB 1.470

05.03.2020  
ID 4911

**DIESE SEITE WURDE BEWUSST  
LEER GELASSEN**

**INTENTIONAL BLANK PAGE**

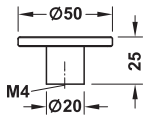

> Oberfläche: Griff: lackiert,  
Sockel: edelstahlfarben

Werkstoff	Artikel-Nr.
Griff: Nussbaum Sockel: Zinkdruckguss	196.45.700
Griff: Eiche Sockel: Zinkdruckguss	196.45.400
Griff: Buche Sockel: Zinkdruckguss	196.45.300

Abpackung: 1 oder 25 Stück

DGH-M 2018, HIDE-de, 06/18; Maßangaben unverbindlich. Konstruktionsänderungen vorbehalten.

Gewindeschrauben M4

► MB 1.470

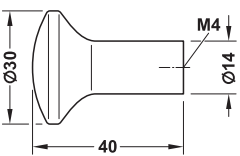
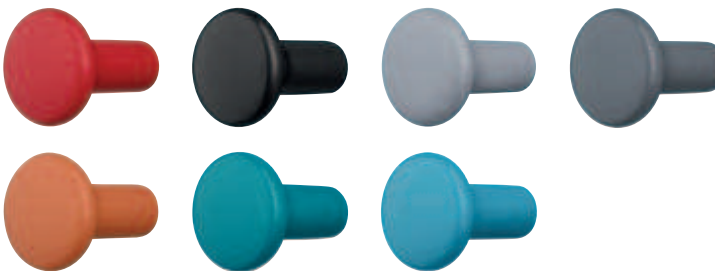
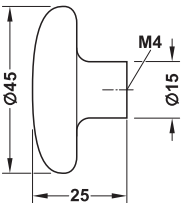

> Designer: Nanna Ditzel

Oberfläche/Farbe	Artikel-Nr.
rot	102.04.250
schwarz	102.04.251
hellgrau	102.04.252
dunkelgrau	102.04.253
terrakottafarben	102.04.254
türkisgrün	102.04.255
türkisblau	102.04.256

Abpackung: 1 oder 10 Stück

> Designer: Nanna Ditzel

Oberfläche/Farbe	Artikel-Nr.
rot	102.04.260
schwarz	102.04.261
hellgrau	102.04.262
dunkelgrau	102.04.263
terrakottafarben	102.04.264
türkisgrün	102.04.265
türkisblau	102.04.266

Abpackung: 1 oder 10 Stück

Gewindeschrauben M4

► MB 1.470



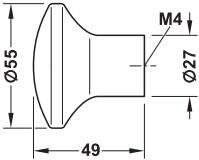
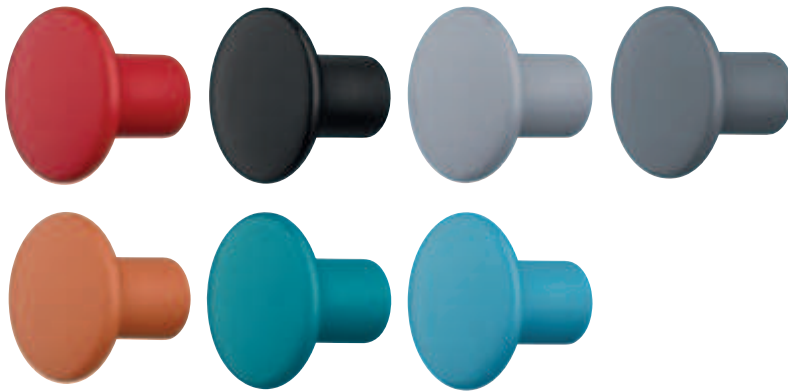

> Designer: Nanna Ditzel

Oberfläche/Farbe	Artikel-Nr.
rot	102.04.270
schwarz	102.04.271
hellgrau	102.04.272
dunkelgrau	102.04.273
terrakottafarben	102.04.274
türkisgrün	102.04.275
türkisblau	102.04.276

Abpackung: 1 oder 10 Stück

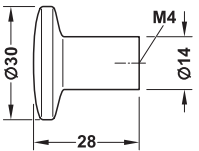
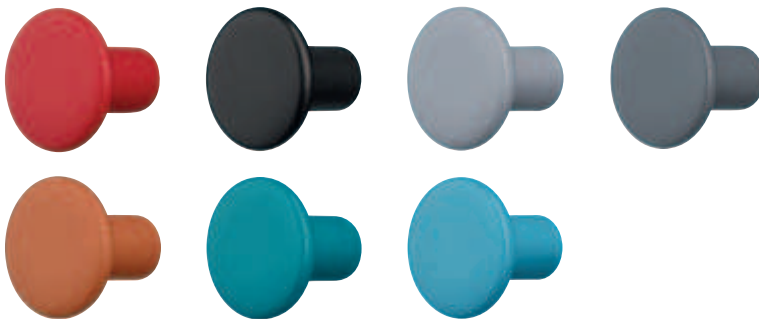

> Designer: Nanna Ditzel

Oberfläche/Farbe	Artikel-Nr.
rot	102.04.280
schwarz	102.04.281
hellgrau	102.04.282
dunkelgrau	102.04.283
terrakottafarben	102.04.284
türkisgrün	102.04.285
türkisblau	102.04.286

Abpackung: 1 oder 10 Stück

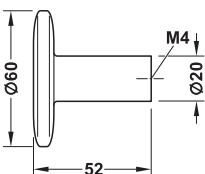
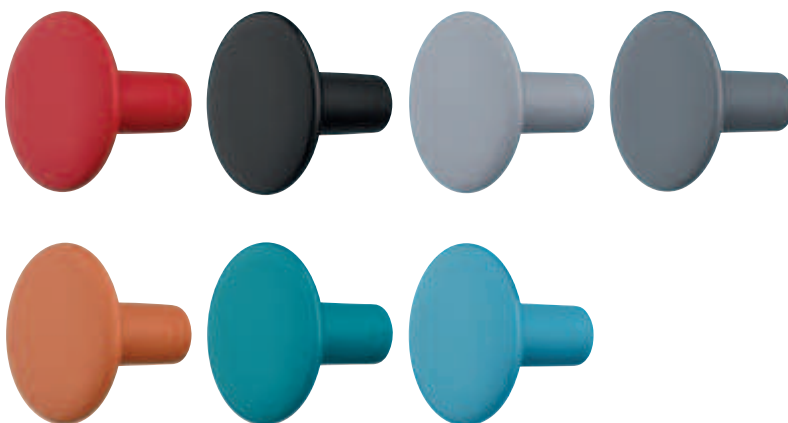

> Designer: Nanna Ditzel

Oberfläche/Farbe	Artikel-Nr.
rot	102.04.290
schwarz	102.04.291
hellgrau	102.04.292
dunkelgrau	102.04.293
terrakottafarben	102.04.294
türkisgrün	102.04.295
türkisblau	102.04.296

Abpackung: 1 oder 10 Stück

Gewindeschrauben M4

► MB 1.470

DGH-M 2018, HDE-de, 06/18; Maßangaben unverbindlich. Konstruktionsänderungen vorbehalten.

Möbelknöpfe Trend

1



Möbelknöpfe Trend

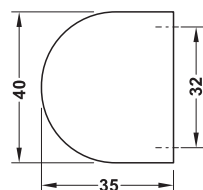
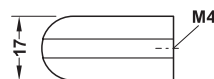
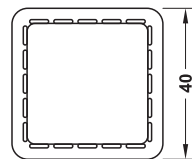
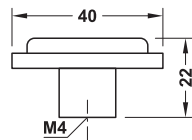
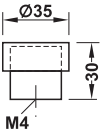
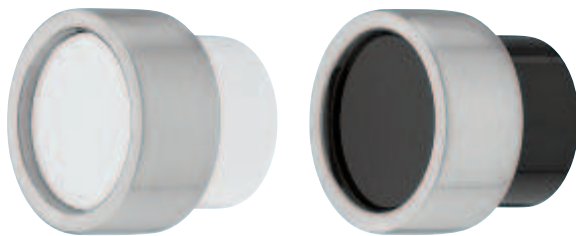

> Werkstoff: Knopf: Kunststoff,  
Ring: Zinkdruckguss

Oberfläche	Artikel-Nr.
Knopf: weiß Ring: vernickelt gebürstet	132.08.670
Knopf: schwarz Ring: vernickelt gebürstet	132.08.630

Abpackung: 1 oder 25 Stück

Oberfläche	Artikel-Nr.
Lederimitation, braun	111.26.500

Abpackung: 1 Stück

> Werkstoff: Griff: Kunststoff,  
Einlage: Aluminium  
> Designer: Dieter Rams

Oberfläche/Farbe	Artikel-Nr.
Griff: schwarz, Einlage: silberfarben eloxiert	102.04.380

Abpackung: 1 oder 5 Stück

Gewindeschrauben M4

► MB 1.470

DGH-M 2018; HDE-de, 06/18; Maßangaben unverbindlich. Konstruktionsänderungen vorbehalten.

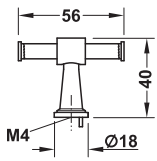
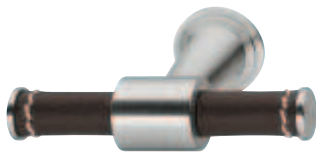

> Werkstoff: Knopf: Edelstahl,  
Einlage: Leder

Oberfläche	Artikel-Nr.
Knopf: matt gebürstet Einlage: dunkelbraun	131.33.010

Abpackung: 1 oder 10 Stück

passender Bogengriff ▶ MB 1.41

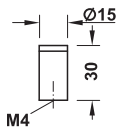

> Werkstoff: Knopf: Edelstahl,  
Einlage: Leder

Oberfläche	Artikel-Nr.
Knopf: matt gebürstet Einlage: dunkelbraun	131.34.010

Abpackung: 1 oder 10 Stück

passender Sockelgriff ▶ MB 1.83

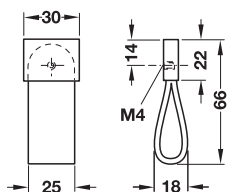

> Werkstoff: Griff: Leder,  
Sockel: Zinkdruckguss

Farbe	Artikel-Nr.
Griff: dunkelbraun Sockel: edelstahlfarben	110.76.011

Abpackung: 1 oder 10 Stück

passender Bogengriff ▶ MB 1.41

Gewindeschrauben M4 ▶ MB 1.470

DGH-M 2018, HIDE-de, 06/18; Maßangaben unverbindlich. Konstruktionsänderungen vorbehalten.

1



Möbelknöpfe Trend

1



Möbelknöpfe Trend

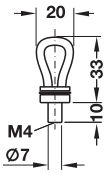

> Werkstoff: Griff: Leder,  
Sockel: Zinkdruckguss

Oberfläche/Farbe	Artikel-Nr.
Griff: hellbraun, Sockel: silberfarben	105.96.190

Abpackung: 1 oder 25 Stück

Passender Bogengriff ▶ MB 1.41

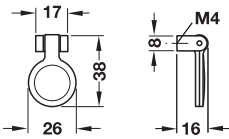

> Werkstoff: Griff: Leder,  
Sockel: Zinkdruckguss

Oberfläche/Farbe	Artikel-Nr.
Griff: braun, Sockel: verchromt poliert	101.18.120

Abpackung: 1 oder 100 Stück

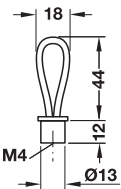
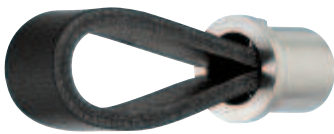

> Werkstoff: Griff: Leder,  
Sockel: Edelstahl, Güte 1.4305/AISI 303

Oberfläche/Farbe	Artikel-Nr.
Griff: schwarz, Sockel: matt	105.94.350

Abpackung: 1 oder 25 Stück

Gewindeschrauben M4 ▶ MB 1.470

DGH-M 2018; HDE-de, 06/18; Maßangaben unverbindlich. Konstruktionsänderungen vorbehalten.

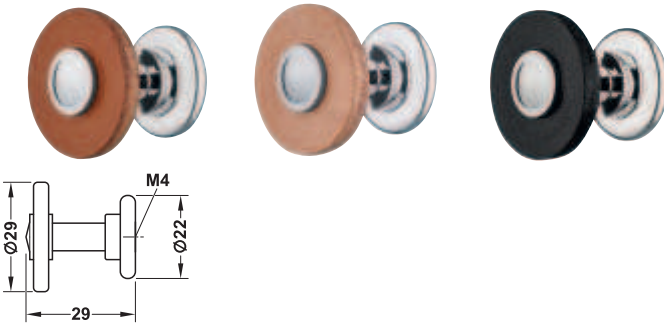

> Werkstoff: Griff: Leder,  
Sockel: Stahl  
> Designer: Michael Graves

Oberfläche/Farbe	Artikel-Nr.
Griff: braun, Sockel: verchromt poliert	102.04.360
Griff: naturbraun, Sockel: verchromt poliert	102.04.361
Griff: anthrazitfarben, Sockel: verchromt poliert	102.04.362

Abpackung: 1 oder 5 Stück

DGH-M 2018, HIDE-de, 06/18; Maßangaben unverbindlich. Konstruktionsänderungen vorbehalten.

passender Möbelgriff	► MB 1.117 B
Gewindeschrauben M4	► MB 1.470

24.02.2020  
ID 4767

**DIESE SEITE WURDE BEWUSST  
LEER GELASSEN**

**INTENTIONAL BLANK PAGE**



# 1

# HÄFELE

ZEITLOS.

PERFEKTE HARMONIE FÜR EIN INDIVIDUELLES AMBIENTE.



1

Möbelgriff Durchmesser 10 mm

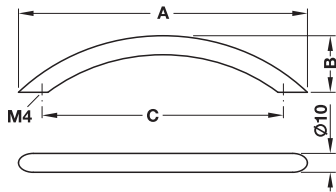

> Werkstoff: Edelstahl, Güte 1.4301/AISI 304  
> Oberfläche: matt gebürstet

Maß A mm	Maß B mm	Maß C mm	Artikel-Nr.
115	30	96	117.64.615
153	30	128	117.64.625
190	32	160	117.64.635
228	32	192	117.64.645
263	32	224	117.64.605
339	32	288	117.64.655
394	41	352	117.64.665
504	50	448	117.64.673

Abpackung: 1 oder 10 Stück

Möbelgriffe zeitlos

Möbelgriff Durchmesser 12 mm

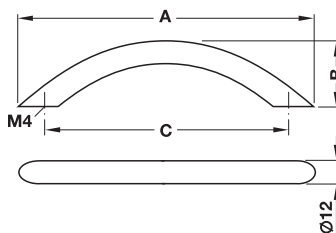

> Werkstoff: Edelstahl, Güte 1.4305  
> Oberfläche: matt gebürstet

Maß A mm	Maß B mm	Maß C mm	Artikel-Nr.
155	35	128	115.82.002
203	34	160	115.82.003
242	35	192	115.82.004
286	37	224	115.82.008
350	43	288	115.82.005

Abpackung: 1 oder 10 Stück

Gewindeschrauben M4

► MB 1.470

DGH-M 2018; HDE-de, 06/18; Maßangaben unverbindlich. Konstruktionsänderungen vorbehalten.

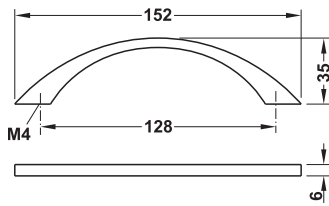

> Werkstoff: Edelstahl, Güte 1.4301/AISI 304  
> Oberfläche: matt gebürstet

Maß A mm	Maß B mm	Maß C mm	Artikel-Nr.
120	35	96	155.01.440
152	35	128	155.01.441
184	35	160	155.01.442

Abpackung: 1 oder 30 Stück

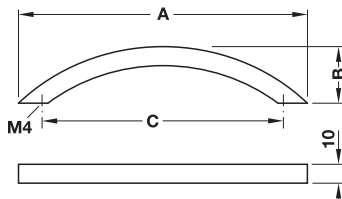

> Werkstoff: Edelstahl, Güte 1.4301/AISI 304  
> Oberfläche: matt gebürstet

Maß A mm	Maß B mm	Maß C mm	Artikel-Nr.
112	31	96	155.01.200
149	31	128	155.01.201
181	31	160	155.01.202
259	32	224	155.01.203
365	33	320	155.01.204

Abpackung: 1 oder 10 Stück

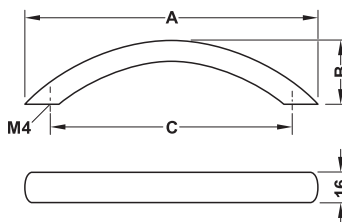

> Werkstoff: Edelstahl, Güte 1.4301/AISI 304  
> Oberfläche: matt gebürstet

Maß A mm	Maß B mm	Maß C mm	Abpackung Stück	Artikel-Nr.
108	30	96	1 oder 25	155.01.450
144	30	128	1 oder 25	155.01.451
181	30	160	1 oder 20	155.01.452
218	30	192	1 oder 20	155.01.453

Gewindeschrauben M4

► MB 1.470

DGH-M 2018, HDE-de, 06/18; Maßangaben unverbindlich. Konstruktionsänderungen vorbehalten.

1

Möbelgriff Durchmesser 10 mm

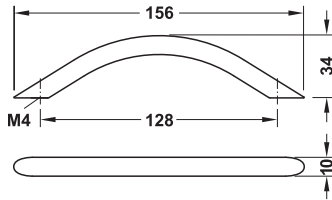

Oberfläche/Farbe	Artikel-Nr.
silberfarben eloxiert	117.67.955
schwarz, matt	117.67.355

Abpackung: 1 oder 10 Stück

Möbelgriffe zeitlos

Möbelgriff Durchmesser 12 mm

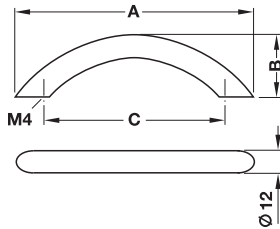

> Oberfläche/Farbe: silberfarben eloxiert

Maß A mm	Maß B mm	Maß C mm	Artikel-Nr.
120	34	96	155.01.000
155	35	128	155.01.001
196	34	160	155.01.002
230	35	192	155.01.003

Abpackung: 1, 25 oder 200 Stück

DGH-M 2018; HDE-de, 06/18; Maßangaben unverbindlich. Konstruktionsänderungen vorbehalten.



<b>Oberfläche</b>	<b>Artikel-Nr.</b>
silberfarben eloxiert	101.03.910
Abpackung: 1 oder 10 Stück	

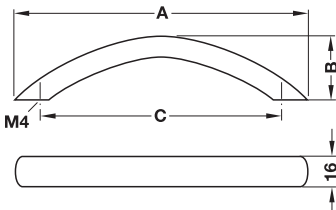
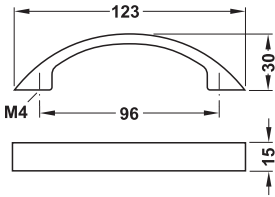

> Oberfläche: silberfarben eloxiert

Maß A mm	Maß B mm	Maß C mm	Artikel-Nr.
113	34	96	100.87.901
151	34	128	100.87.902
188	34	160	100.87.903
227	34	192	100.87.904
262	34	224	100.87.905

Abpackung: 1 oder 25 Stück

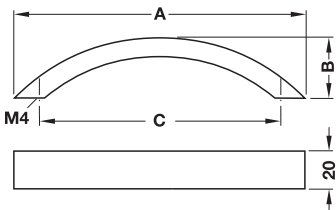

> Oberfläche/Farbe: silberfarben eloxiert

Maß A mm	Maß B mm	Maß C mm	Artikel-Nr.
155	32	128	155.01.010
229	37	192	155.01.011

Abpackung: 1, 25 oder 100 Stück

Gewindeschrauben M4 ▶ FF 1.260

DGH-M 2018, HIDE-de, 06/18; Maßangaben unverbindlich. Konstruktionsänderungen vorbehalten.

1



Möbelgriffe zeitlos

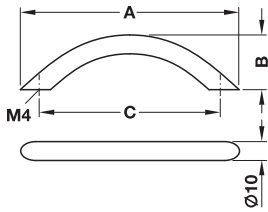
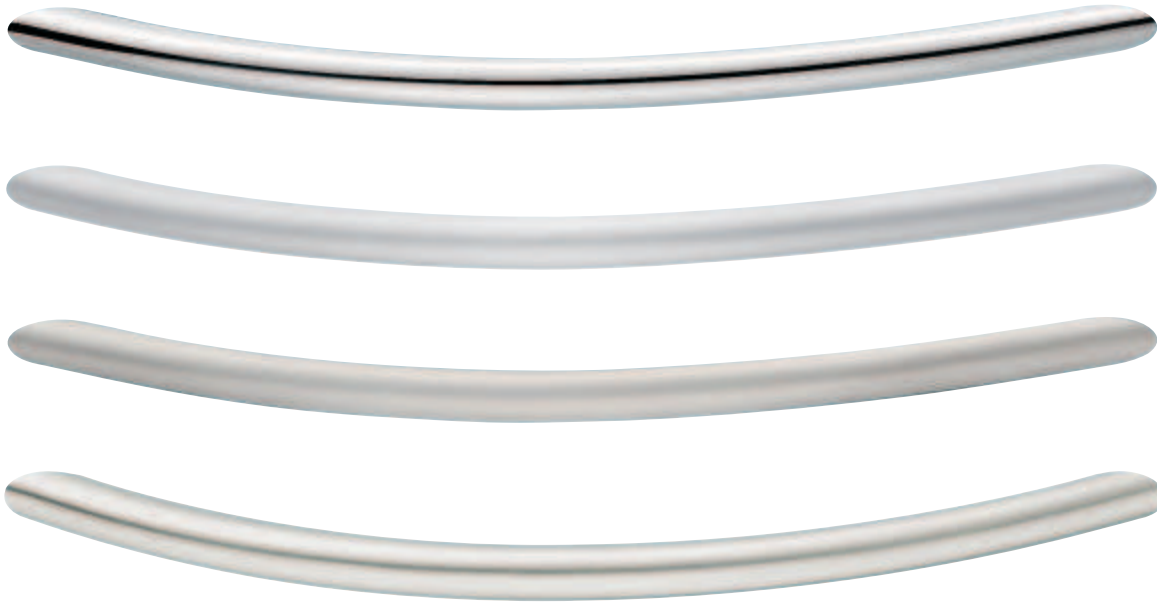

Oberfläche/Farbe	Maß A mm	Maß B mm	Maß C mm	Artikel-Nr.
verchromt poliert	112	30	96	155.00.820
	148	30	128	155.00.821
	184	32	160	155.00.822
	221	32	192	155.00.823
	297	32	256	155.00.824
	332	31	288	155.00.825
verchromt matt	392	41	352	155.00.826
	112	30	96	155.00.830
	148	30	128	155.00.831
	184	32	160	155.00.832
	221	32	192	155.00.833
	297	32	256	155.00.834
vernickelt matt	332	31	288	155.00.835
	392	41	352	155.00.836
	112	30	96	155.00.840
	148	30	128	155.00.841
	184	32	160	155.00.842
	221	32	192	155.00.843
vernickelt gebürstet	297	32	256	155.00.844
	332	31	288	155.00.845
	392	41	352	155.00.846
	112	30	96	155.00.850
	148	30	128	155.00.851
	184	32	160	155.00.852
	221	32	192	155.00.853
	297	32	256	155.00.854
	332	31	288	155.00.855
	392	41	352	155.00.856

Abpackung: 1 oder 25 Stück

Gewindeschrauben M4

► MB 1.470



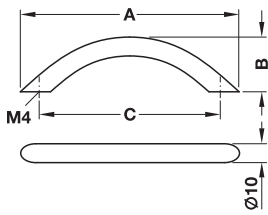

Oberfläche/Farbe	Maß A mm	Maß B mm	Maß C mm	Artikel-Nr.
oil rubbed bronze, Used Look	112	30	96	155.00.860
	148	30	128	155.00.861
	184	32	160	155.00.862
	221	32	192	155.00.863
	332	31	288	155.00.865
	392	41	352	155.00.866
oil rubbed bronze, dunkel, Used Look	112	30	96	155.00.870
	148	30	128	155.00.871
	184	32	160	155.00.872
	221	32	192	155.00.873
	332	31	288	155.00.875
	392	41	352	155.00.876
schwarz, matt, RAL 9017	112	30	96	155.00.880
	148	30	128	155.00.881
	184	32	160	155.00.882
	221	32	192	155.00.883
	332	31	288	155.00.885

Abpackung: 1 oder 25 Stück

Gewindeschrauben M4 ▶ MB 1.470

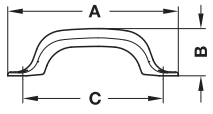

> Oberfläche: vernickelt poliert

Maß A mm	Maß B mm	Maß C mm	Schrauben-Durchmesser mm	Artikel-Nr.
87	28	73	2,5	162.00.729
115	31	99	3,0	162.00.739
140	36	120	3,5	162.00.759

Abpackung: 1 oder 25 Stück

Holzschrauben Linsensenkopf DIN 95 ▶ MB 1.471

DGH-M 2018, HIDE-de, 06/18; Maßangaben unverbindlich. Konstruktionsänderungen vorbehalten.

1

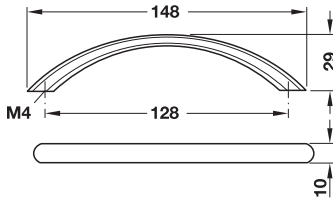

Oberfläche	Artikel-Nr.
verchromt matt	103.02.400

Abpackung: 1 oder 10 Stück

Möbelgriffe zeitlos

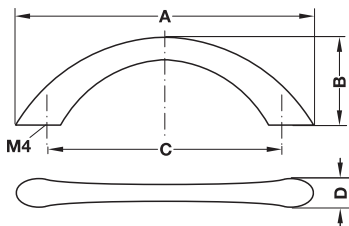

Oberfläche	Maß A mm	Maß B mm	Maß C mm	Maß D mm	Abpackung Stück	Artikel-Nr.
verchromt poliert	81	24	64	11	1 oder 30	155.00.480
	112	24	96	9	1 oder 25	155.00.481
	155	30	128	11	1 oder 25	155.00.482
verchromt matt	81	24	64	11	1 oder 30	155.00.470
	112	24	96	9	1 oder 25	155.00.471
	155	30	128	11	1 oder 25	155.00.472
vernickelt gebürstet	81	24	64	11	1 oder 30	155.00.490
	112	24	96	9	1 oder 25	155.00.491
	155	30	128	11	1 oder 25	155.00.492
	203	30	160	12	1 oder 20	155.00.493
vernickelt matt	286	33	224	16	1 oder 20	155.00.494
	112	24	96	9	1 oder 25	155.00.460
	155	30	128	11	1 oder 25	155.00.461

Gewindeschrauben M4

► MB 1.470

DGH-M 2018; HDE-de, 06/18; Maßangaben unverbindlich. Konstruktionsänderungen vorbehalten.

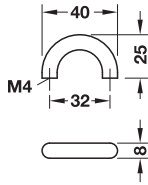
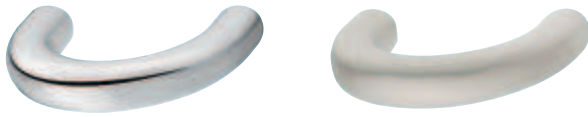

Oberfläche	Artikel-Nr.
verchromt poliert	104.62.200
vernickelt matt	104.62.600

Abpackung: 1 oder 25 Stück

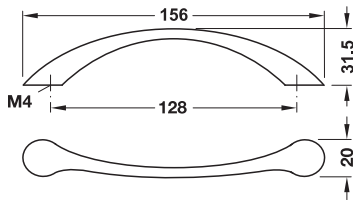

Oberfläche	Artikel-Nr.
edelstahlfarben	103.33.402

Abpackung: 1 oder 25 Stück

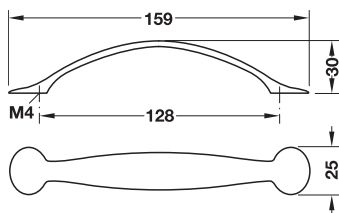

Oberfläche	Artikel-Nr.
vernickelt matt	103.05.600

Abpackung: 1 oder 10 Stück

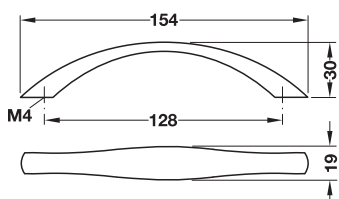

Oberfläche	Artikel-Nr.
verchromt matt	110.09.400

Abpackung: 1 oder 25 Stück

Gewindeschrauben M4

► MB 1.470

DGH-M 2018, HIDE-de, 06/18; Maßangaben unverbindlich. Konstruktionsänderungen vorbehalten.

1



Möbelgriffe zeitlos

1

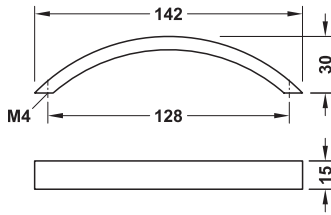

Oberfläche	Artikel-Nr.
vernickelt gebürstet	155.00.450

Abpackung: 1 oder 25 Stück

Möbelgriffe zeitlos

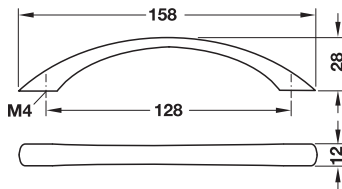

Oberfläche/Farbe	Artikel-Nr.
verchromt poliert	155.00.510
vernickelt gebürstet	155.00.520
goldfarben, poliert	155.00.500
schwarz, matt	155.00.530

Abpackung: 1 oder 25 Stück

Gewindeschrauben M4

► MB 1.470

DGH-M 2018; HDE-de, 06/18; Maßangaben unverbindlich. Konstruktionsänderungen vorbehalten.

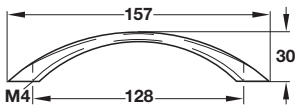

Oberfläche	Artikel-Nr.
verchromt matt	107.66.401
vernickelt matt	107.66.601

Abpackung: 1 oder 25 Stück

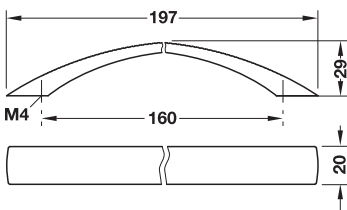

Oberfläche	Artikel-Nr.
verchromt poliert	101.12.203
verchromt matt	101.12.403
vernickelt gebürstet	101.12.603

Abpackung: 1 oder 25 Stück

Gewindeschrauben M4

► MB 1.470

DGH-M 2018, HIDE-de, 06/18; Maßangaben unverbindlich. Konstruktionsänderungen vorbehalten.

1

Möbelgriffe zeitlos

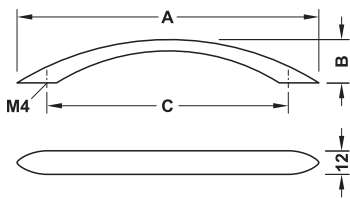

Oberfläche	Maß A mm	Maß B mm	Maß C mm	Artikel-Nr.
verchromt poliert	127	23	96	155.00.620
	160	23	128	155.00.621
verchromt matt	127	23	96	155.00.610
	160	23	128	155.00.611
vernickelt gebürstet	127	23	96	155.00.600
	160	23	128	155.00.601
oil rubbed bronze	127	23	96	155.00.630
	160	23	128	155.00.631

Abpackung: 1 oder 25 Stück

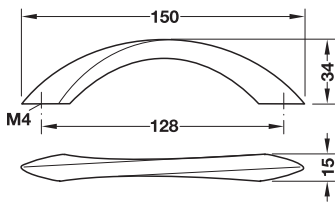

Oberfläche	Artikel-Nr.
verchromt matt	155.00.120
vernickelt matt	155.00.130

Abpackung: 1 oder 25 Stück

Gewindeschrauben M4

► MB 1.470

DGH-M 2018; HDE-de, 06/18; Maßangaben unverbindlich. Konstruktionsänderungen vorbehalten.



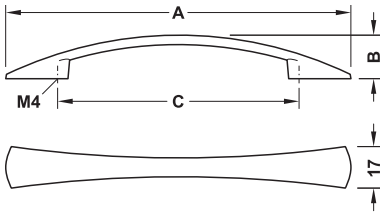
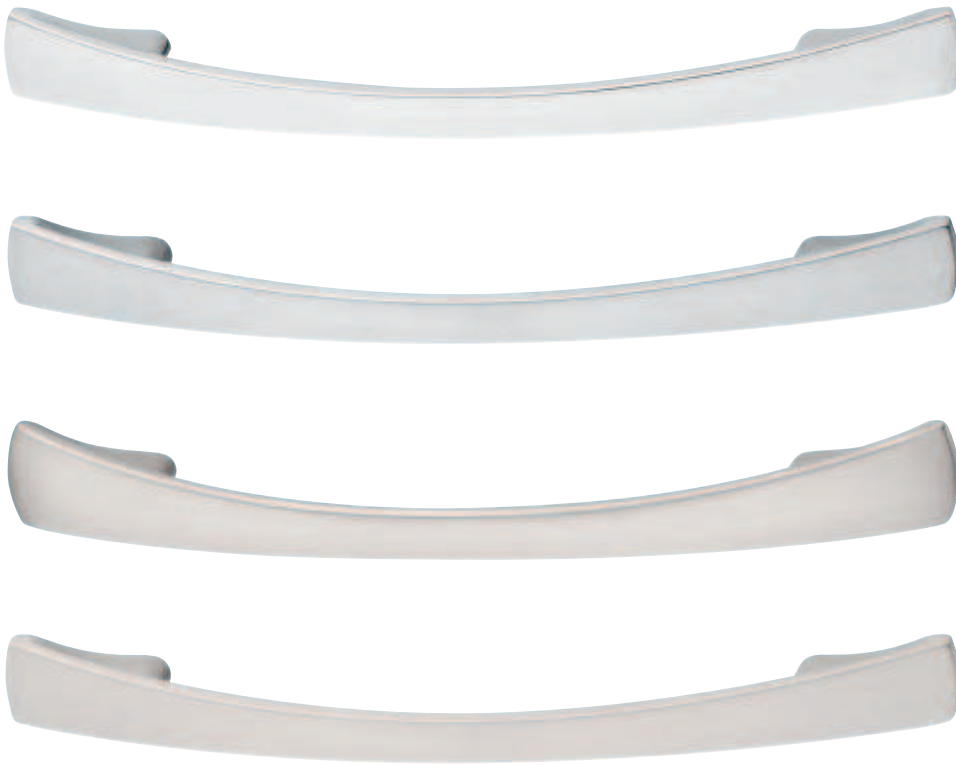

Oberfläche	Maß A mm	Maß B mm	Maß C mm	Abpackung Stück	Artikel-Nr.
verchromt poliert	183	23	128	1 oder 20	155.00.220
verchromt matt	183	23	128	1 oder 20	155.00.210
vernickelt gebürstet	142	23	96	1 oder 25	155.00.440
	183	23	128	1 oder 20	155.00.441
vernickelt matt	183	23	128	1 oder 20	155.00.200

Möbelgriffe zeitlos

DGH-M 2018, HIDE-de, 06/18; Maßangaben unverbindlich. Konstruktionsänderungen vorbehalten.

Gewindeschrauben M4

► MB 1.470

17.05.2019  
ID 4568

1



Möbelgriffe zeitlos

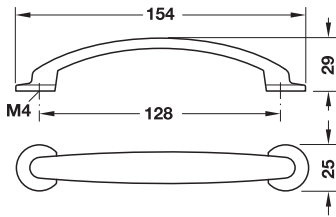

Oberfläche	Artikel-Nr.
vernickelt gebürstet	155.00.650
vernickelt matt	155.00.640

Abpackung: 1 oder 25 Stück

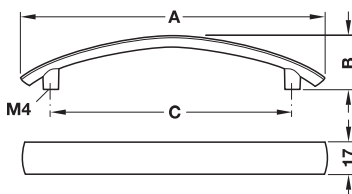
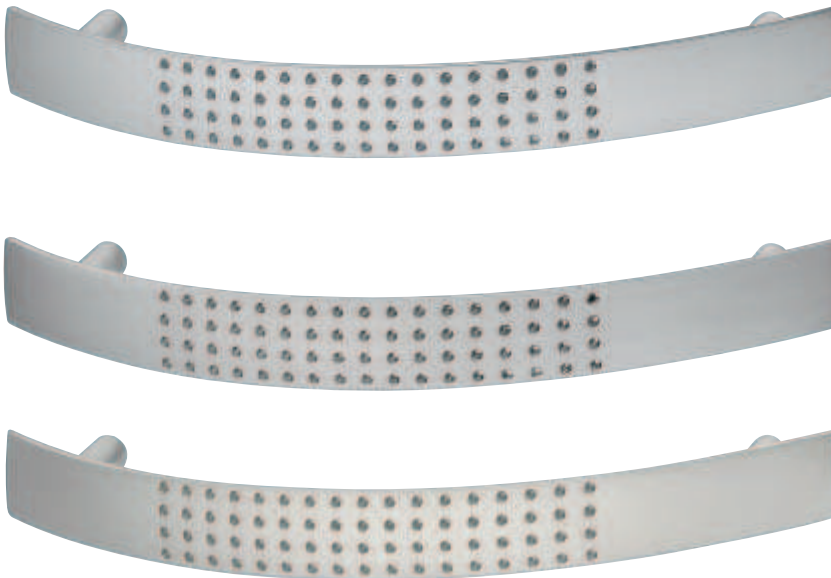

Oberfläche	Maß A mm	Maß B mm	Maß C mm	Artikel-Nr.
verchromt matt	124	27	96	101.69.401
	160	29	128	101.69.402
edelstahlfarben	124	27	96	101.69.001
	160	29	128	101.69.002
vernickelt matt	124	27	96	101.69.601
	160	29	128	101.69.602

Abpackung: 25 Stück

Gewindeschrauben M4

► MB 1.470

DGH-M 2018; HDE-de, 06/18; Maßangaben unverbindlich. Konstruktionsänderungen vorbehalten.

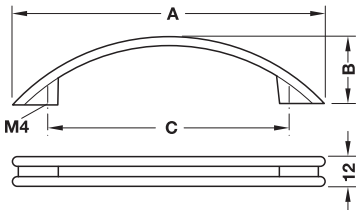
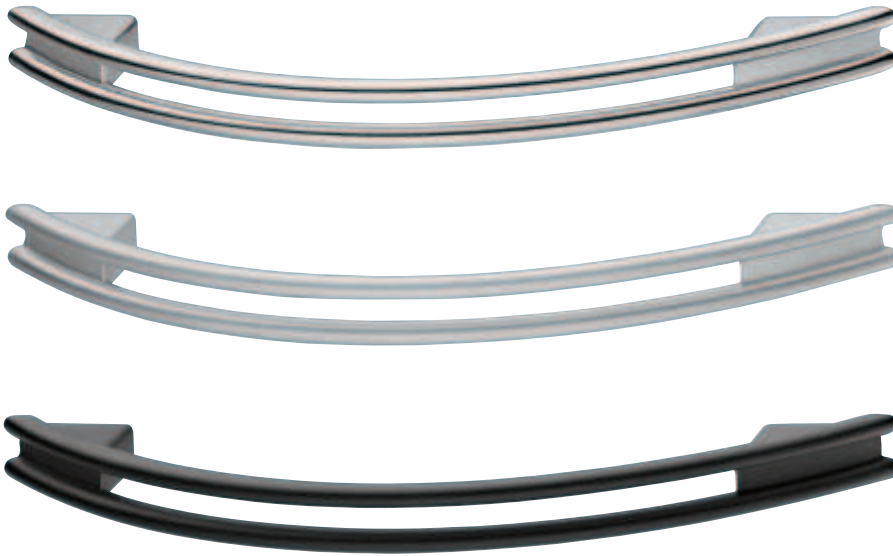

Oberfläche/ Farbe	Maß A mm	Maß B mm	Maß C mm	Abpackung Stück	Artikel-Nr.
verchromt poliert	124	28	96	1 oder 25	155.00.680
verchromt matt	167	27	128	1 oder 20	155.00.681
verchromt matt	124	28	96	1 oder 25	155.00.660
schwarz, matt	167	27	128	1 oder 20	155.00.671

DGH-M 2018, HIDE-de, 06/18; Maßangaben unverbindlich. Konstruktionsänderungen vorbehalten.

Gewindeschrauben M4

► MB 1.470

1

Möbelgriff Durchmesser 8 mm

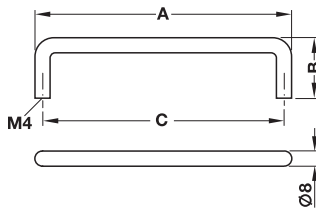

> Werkstoff: Edelstahl, Güte 1.4301/AISI 304  
> Oberfläche: matt gebürstet

Maß A mm	Maß B mm	Maß C mm	Artikel-Nr.
72	32	64	155.01.220
90	32	82	155.01.221
104	32	96	155.01.222
120	32	112	155.01.223
136	32	128	155.01.224
168	32	160	155.01.225
200	32	192	155.01.226

Abpackung: 1 oder 20 Stück

Gewindeschrauben M4

► MB 1.470

Möbelgriffe zeitlos

Rosette

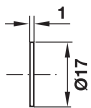

> Werkstoff: Edelstahl, Güte 1.4305/AISI 303

Oberfläche	Artikel-Nr.
blank	116.10.094

Abpackung: 1 oder 50 Stück

DGH-M 2018; HDE-de, 06/18; Maßangaben unverbindlich. Konstruktionsänderungen vorbehalten.

Möbelgriff Durchmesser 10 mm

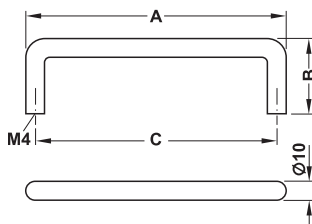
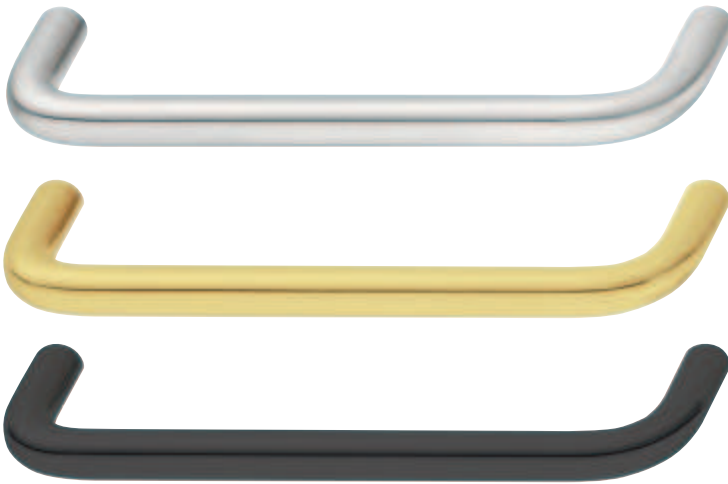

> Werkstoff: Edelstahl, Güte 1.4301/AISI 304

Oberfläche/Farbe	Maß A mm	Maß B mm	Maß C mm	Artikel-Nr.
matt gebürstet	74	35	64	155.01.230
	106	35	96	155.01.231
	138	35	128	155.01.232
	170	35	160	155.01.233
	202	35	192	155.01.234
	234	35	224	155.01.235
	298	35	288	155.01.236
	362	35	352	155.01.237
vermessingt poliert, PVD beschichtet	106	35	96	112.04.070
	138	35	128	112.04.071
schwarz, matt, PVD beschichtet	106	35	96	112.04.072
	138	35	128	112.04.073

Abpackung: 1 oder 20 Stück

Möbelgriff Durchmesser 10 mm – Topco

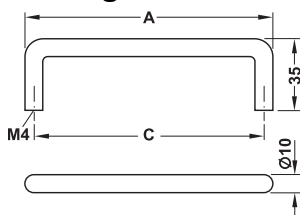

> Werkstoff: Edelstahl, Güte 1.4305/AISI 303  
> Oberfläche: matt gebürstet

Länge mm	Artikel-Nr.
Fixlänge (bis 1.800 mm)	117.40.619

Abpackung: 1 Stück

**topCo** KUNDENINDIVIDUELL  
BEREITS AB EINEM STÜCK

Folgende Eigenschaften können Sie wählen:

- > Grifflänge (Maß A)
- > Lochabstand (Maß C)

Gewindeschrauben M4

► MB 1.470

1

Möbelgriff Durchmesser 12 mm

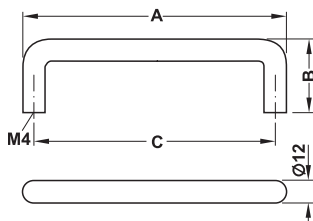

Möbelgriffe zeitlos

**Kundenindividuelle Topco-Leistungen**  
Andere Größen und Ausführungen sind als Topco-Leistung lieferbar.

> Werkstoff: Edelstahl, Güte 1.4305  
> Oberfläche: matt gebürstet

Maß A mm	Maß B mm	Maß C mm	Artikel-Nr.
108	35	96	115.51.610
140	40	128	115.51.620
172	40	160	115.51.630
204	40	192	115.51.640
236	40	224	115.51.641
300	40	288	115.51.650
460	40	448	115.51.670

Abpackung: 1 oder 10 Stück

Möbelgriff Durchmesser 12 mm – Topco

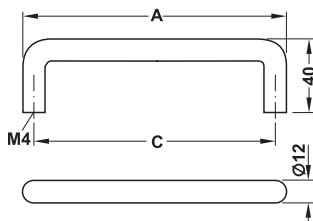

> Oberfläche: matt gebürstet

Länge mm	Werkstoff	Artikel-Nr.
Fixlänge (bis 1.800 mm)	Edelstahl, Güte 1.4305	115.51.619
	Edelstahl, Güte 1.4571	115.51.669

Abpackung: 1 Stück

**topCo** KUNDENINDIVIDUELL  
BEREITS AB EINEM STÜCK

Folgende Eigenschaften können Sie wählen:

- > Grifflänge (Maß A)
- > Lochabstand (Maß C, ggf. C1)
- > Edelstahlgüte 1.4305 oder 1.4571

Gewindeschrauben M4

► MB 1.470

DGH-M 2018; HDE-de, 06/18; Maßangaben unverbindlich. Konstruktionsänderungen vorbehalten.



Möbelgriff Durchmesser 14 mm

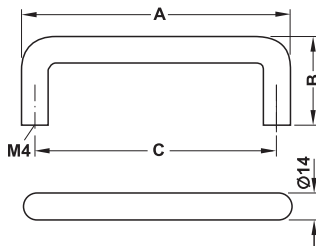

**Kundenindividuelle Topco-Leistungen**  
Andere Größen und Ausführungen sind als Topco-Leistung lieferbar.

> Werkstoff: Edelstahl, Güte 1.4305  
> Oberfläche: matt gebürstet

Maß A mm	Maß B mm	Maß C mm	Artikel-Nr.
110	45	96	117.50.610
142	45	128	115.52.620
174	45	160	115.52.630
206	45	192	115.52.640
238	45	224	115.52.645
302	45	288	115.52.650
462	45	448	115.52.670

Abpackung: 1 oder 10 Stück

Möbelgriff Durchmesser 14 mm – Topco

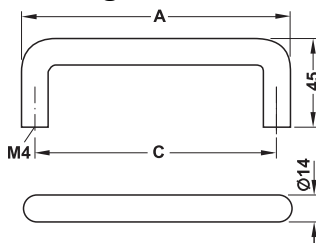

> Werkstoff: Edelstahl, Güte 1.4305  
> Oberfläche: matt gebürstet

Länge mm	Artikel-Nr.
Fixlänge (bis 1.800 mm)	115.52.619

Abpackung: 1 Stück

**topCo** KUNDENINDIVIDUELL  
BEREITS AB EINEM STÜCK

Folgende Eigenschaften können Sie wählen:

- > Grifflänge (Maß A)
- > Lochabstand (Maß C, ggf. C1)

DGH-M 2018, HIDE-de, 06/18; Maßangaben unverbindlich. Konstruktionsänderungen vorbehalten.

Gewindeschrauben M4

► MB 1.470



Möbelgriff Durchmesser 10 mm

1

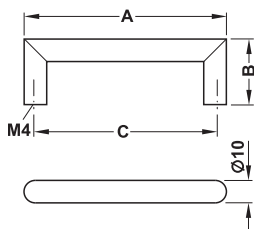

> Werkstoff: Edelstahl, Güte 1.4301/AISI 304  
> Oberfläche: matt gebürstet

Maß A mm	Maß B mm	Maß C mm	Abpackung Stück	Artikel-Nr.
106	35	96	1 oder 20	155.01.240
138	35	128	1 oder 20	155.01.241
170	35	160	1 oder 20	155.01.242
202	35	192	1 oder 20	155.01.243
234	35	224	1 oder 20	155.01.244
298	35	288	1 oder 10	155.01.245
330	35	320	1 oder 10	155.01.246
362	35	352	1 oder 10	155.01.247
458	35	448	1 oder 10	155.01.248
570	35	560	1 oder 8	155.01.249

Möbelgriffe zeitlos

Möbelgriff Durchmesser 10 mm – Topco

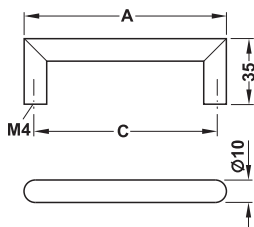

> Werkstoff: Edelstahl, Güte 1.4305/AISI 303  
> Oberfläche: matt gebürstet

Länge mm	Artikel-Nr.
Fixlänge (bis 2.000 mm)	115.77.019

Abpackung: 1 Stück

**Bestellhinweis**

Zur Stabilisierung sind erforderlich  
> ab Länge 1.000 mm: 3 Sockel  
> ab Länge 1.600 mm: 4 Sockel

**topCo** KUNDENINDIVIDUELL  
BEREITS AB EINEM STÜCK

Folgende Eigenschaften können Sie wählen:

- > Grifflänge (Maß A)
- > Lochabstand (Maß C, ggf. C1)
- > Anzahl Sockel

Gewindeschrauben M4

► MB 1.470

DGH-M 2018; HDE-de, 06/18; Maßangaben unverbindlich. Konstruktionsänderungen vorbehalten.

Möbelgriff Durchmesser 12 mm

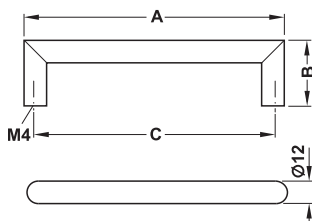

> Werkstoff: Edelstahl, Güte 1.4301/AISI 304  
> Oberfläche: matt gebürstet

Maß A mm	Maß B mm	Maß C mm	Abpackung Stück	Artikel-Nr.
108	35	96	1 oder 10	155.01.250
140	35	128	1 oder 10	155.01.251
172	35	160	1 oder 10	155.01.252
204	35	192	1 oder 10	155.01.253
236	35	224	1 oder 10	155.01.254
300	35	288	1 oder 10	155.01.255
332	35	320	1 oder 10	155.01.256
364	35	352	1 oder 8	155.01.257
460	35	448	1 oder 8	155.01.258
492	35	480	1 oder 7	155.01.259
572	35	560	1 oder 6	155.01.260
652	35	640	1 oder 20	155.01.261
972	35	960	1 oder 10	155.01.262

Möbelgriffe zeitlos

1

Möbelgriff Durchmesser 12 mm – Topco

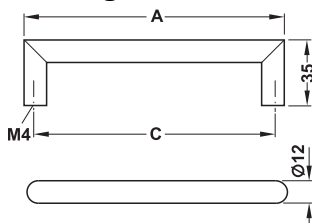

> Werkstoff: Edelstahl, Güte 1.4305/AISI 303  
> Oberfläche: matt gebürstet

Länge mm	Artikel-Nr.
Fixlänge (bis 2.000 mm)	115.78.019

Abpackung: 1 Stück

**Bestellhinweis**

Zur Stabilisierung sind erforderlich  
> ab Länge 1.000 mm: 3 Sockel  
> ab Länge 1.600 mm: 4 Sockel

**topCo** KUNDENINDIVIDUELL  
BEREITS AB EINEM STÜCK

Folgende Eigenschaften können Sie wählen:

- > Grifflänge (Maß A)
- > Lochabstand (Maß C, ggf. C1)
- > Anzahl Sockel

Gewindeschrauben M4

► MB 1.470

DGH-M 2018, HDE-de, 06/18; Maßangaben unverbindlich. Konstruktionsänderungen vorbehalten.

1

Möbelgriffe zeitlos

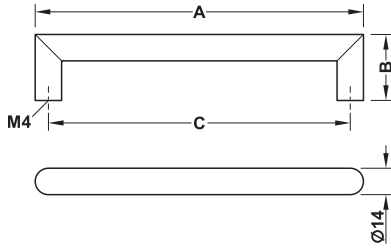

> Werkstoff: Edelstahl, Güte 1.4301/AISI 304  
> Oberfläche: matt gebürstet

Maß A mm	Maß B mm	Maß C mm	Abpackung Stück	Artikel-Nr.
110	35	96	1 oder 10	155.01.270
142	35	128	1 oder 10	155.01.271
174	35	160	1 oder 10	155.01.272
206	35	192	1 oder 10	155.01.273
238	35	224	1 oder 10	155.01.274
302	35	288	1 oder 8	155.01.275
366	35	352	1 oder 7	155.01.276
462	35	448	1 oder 5	155.01.277
574	35	560	1 oder 5	155.01.278

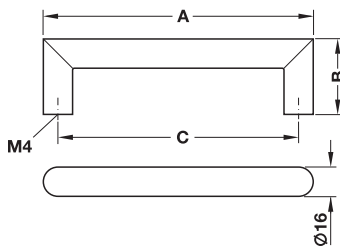

> Werkstoff: Edelstahl, Güte 1.4301/AISI 304  
> Oberfläche: matt gebürstet

Maß A mm	Maß B mm	Maß C mm	Artikel-Nr.
176	40	160	155.01.280
208	40	192	155.01.281
240	40	224	155.01.282
304	40	288	155.01.283
368	40	352	155.01.284
464	40	448	155.01.285

Abpackung: 1 oder 10 Stück

Gewindeschrauben M4

► MB 1.470

DGH-M 2018; HDE-de, 06/18; Maßangaben unverbindlich. Konstruktionsänderungen vorbehalten.

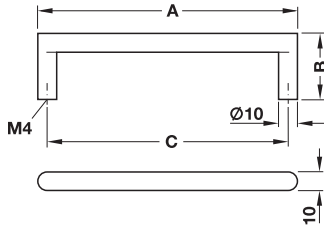

> Werkstoff: Edelstahl, Güte 1.4301/AISI 304  
> Oberfläche: matt gebürstet

Maß A mm	Maß B mm	Maß C mm	Artikel-Nr.
106	35	96	155.01.300
138	35	128	155.01.301
170	35	160	155.01.302
202	35	192	155.01.303
234	35	224	155.01.304
266	35	256	155.01.305
298	35	288	155.01.306
330	35	320	155.01.307

Abpackung: 1 oder 10 Stück

Möbelgriffe zeitlos

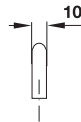
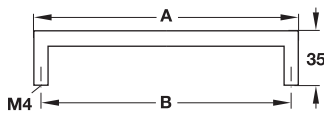

> Werkstoff: Edelstahl, Güte 1.4301/AISI 304  
> Oberfläche: matt gebürstet

Maß A mm	Maß B mm	Abpackung Stück	Artikel-Nr.
106	96	1 oder 10	155.01.290
138	128	1 oder 10	155.01.291
170	160	1 oder 10	155.01.292
202	192	1 oder 10	155.01.293
234	224	1 oder 10	155.01.294
298	288	1 oder 10	155.01.295
362	352	1 oder 10	155.01.296
458	448	1 oder 10	155.01.297
570	560	1 oder 8	155.01.298

Gewindeschrauben M4

► MB 1.470

1

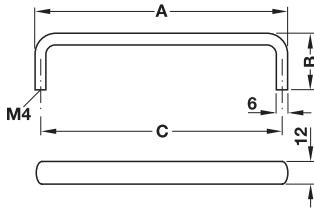

> Werkstoff: Edelstahl  
> Oberfläche: matt gebürstet

Maß A mm	Maß B mm	Maß C mm	Abpackung Stück	Artikel-Nr.
70	30	64	1	116.11.626
102	30	96	1 oder 10	116.11.635
134	30	128	1 oder 10	116.11.644
166	30	160	1 oder 10	116.11.650
198	30	192	1 oder 10	116.11.662
262	30	256	1 oder 10	116.11.671
294	30	288	1 oder 10	116.11.680
358	30	352	1 oder 10	116.11.715

Möbelgriffe zeitlos

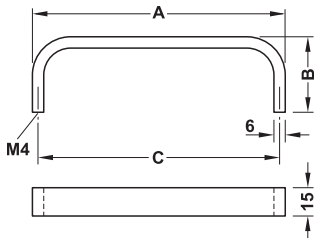

> Werkstoff: Edelstahl, Güte 1.4301/AISI 304  
> Oberfläche: matt gebürstet

Maß A mm	Maß B mm	Maß C mm	Artikel-Nr.
134	40	128	116.11.012
166	40	160	116.11.013
198	40	192	116.11.014
230	40	224	116.11.015
294	40	288	116.11.017

Abpackung: 1 oder 10 Stück

Gewindeschrauben M4

► MB 1.470

DGH-M 2018; HDE-de, 06/18; Maßangaben unverbindlich. Konstruktionsänderungen vorbehalten.



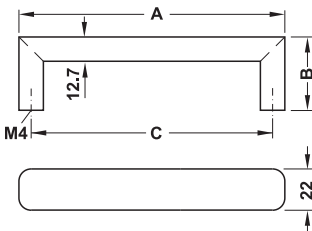

> Werkstoff: Edelstahl, Güte 1.4301/AISI 304  
> Oberfläche: matt gebürstet

Maß A mm	Maß B mm	Maß C mm	Artikel-Nr.
140	39	128	155.01.580
172	39	160	155.01.581
204	39	192	155.01.582
332	39	320	155.01.583

Abpackung: 1 oder 50 Stück

DGH-M 2018, HIDE-de, 06/18; Maßangaben unverbindlich. Konstruktionsänderungen vorbehalten.

Gewindeschrauben M4

► MB 1.470

14.09.2019  
ID 4255

Möbelgriff – Topco

1



Möbelgriffe zeitlos

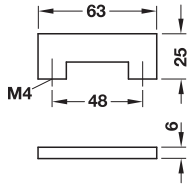

> Werkstoff: Edelstahl, Güte 1.4301/AISI 304

Oberfläche	Artikel-Nr.
matt gebürstet	112.01.000

Abpackung: 1 oder 10 Stück

**topCo** KUNDENINDIVIDUELL  
BEREITS AB EINEM STÜCK

Dieser Griff ist auch mit einer Logo-Beschriftung erhältlich.

Laser-Beschriftung ▶ MB 1.206

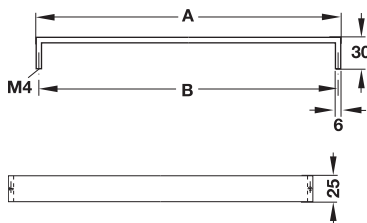

> Werkstoff: Edelstahl, Güte 1.4301/AISI 304  
> Oberfläche: matt gebürstet

Maß A mm	Maß B mm	Abpackung Stück	Artikel-Nr.
166	160	1 oder 10	155.01.310
198	192	1 oder 10	155.01.311
230	224	1 oder 10	155.01.312
294	288	1 oder 8	155.01.313

Gewindeschrauben M4 ▶ MB 1.470

DGH-M 2018; HDE-de, 06/18; Maßangaben unverbindlich. Konstruktionsänderungen vorbehalten.

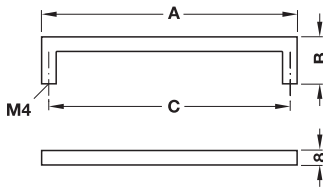

> Werkstoff: Edelstahl, Güte 1.4301/AISI 304  
> Oberfläche: matt gebürstet

Maß A mm	Maß B mm	Maß C mm	Artikel-Nr.
104	25	96	155.01.330
136	25	128	155.01.331
168	25	160	155.01.332
200	25	192	155.01.333
232	25	224	155.01.334
264	25	256	155.01.335
296	25	288	155.01.336
328	25	320	155.01.337

Abpackung: 1 oder 20 Stück

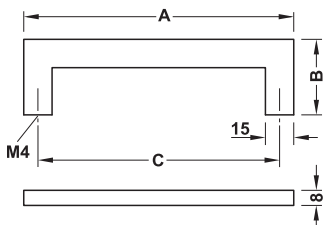

> Werkstoff: Edelstahl, Güte 1.4305/AISI 303  
> Oberfläche: matt gebürstet

Maß A mm	Maß B mm	Maß C mm	Artikel-Nr.
143	40	128	100.45.012
175	40	160	100.45.013
207	40	192	100.45.014
239	40	224	100.45.015
303	40	288	100.45.017

Abpackung: 1 oder 10 Stück

DGH-M 2018, HIDE-de, 06/18; Maßangaben unverbindlich. Konstruktionsänderungen vorbehalten.

Gewindeschrauben M4

► MB 1.470

1

Möbelgriffe zeitlos

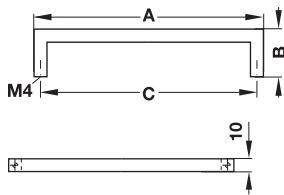

> Werkstoff: Edelstahl, Güte 1.4301/AISI 304

Oberfläche/Farbe	Maß A mm	Maß B mm	Maß C mm	Abpackung Stück	Artikel-Nr.
matt gebürstet	106	35	96	1 oder 10	155.01.340
	138	35	128	1 oder 10	155.01.341
	170	35	160	1 oder 10	155.01.342
	202	35	192	1 oder 10	155.01.343
	234	35	224	1 oder 10	155.01.344
	298	35	288	1 oder 10	155.01.345
	362	35	352	1 oder 10	155.01.346
	458	35	448	1 oder 8	155.01.347
	570	35	560	1 oder 7	155.01.348
vermessingt poliert, PVD beschichtet	106	35	96	1 oder 30	112.04.080
	138	35	128	1 oder 20	112.04.081
schwarz, matt, PVD beschichtet	106	35	96	1 oder 30	112.04.082
	138	35	128	1 oder 20	112.04.083

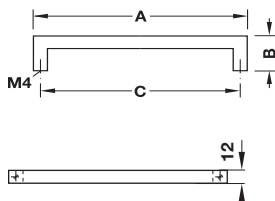

> Werkstoff: Edelstahl, Güte 1.4301/AISI 304  
> Oberfläche: matt gebürstet

Maß A mm	Maß B mm	Maß C mm	Abpackung Stück	Artikel-Nr.
108	35	96	1 oder 10	155.01.350
140	35	128	1 oder 10	155.01.351
172	35	160	1 oder 10	155.01.352
204	35	192	1 oder 10	155.01.353
236	35	224	1 oder 10	155.01.354
300	35	288	1 oder 8	155.01.355
364	35	352	1 oder 7	155.01.356
460	35	448	1 oder 5	155.01.357
572	35	560	1 oder 5	155.01.358

Gewindeschrauben M4

► MB 1.470

DGH-M 2018; HDE-de, 06/18; Maßangaben unverbindlich. Konstruktionsänderungen vorbehalten.

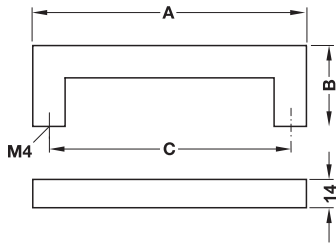

> Werkstoff: Edelstahl, Güte 1.4301/AISI 304  
> Oberfläche: matt gebürstet

Maß A mm	Maß B mm	Maß C mm	Abpackung Stück	Artikel-Nr.
142	40	128	1 oder 50	155.01.590
174	40	160	1 oder 50	155.01.591
206	40	192	1 oder 50	155.01.592
238	40	224	1 oder 50	155.01.593
302	40	288	1 oder 50	155.01.594
334	40	320	1 oder 50	155.01.595
654	40	640	1 oder 25	155.01.596

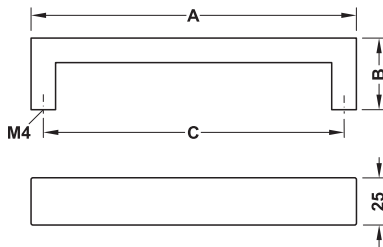

> Werkstoff: Edelstahl, Güte 1.4301/AISI 304  
> Oberfläche: matt gebürstet

Maß A mm	Maß B mm	Maß C mm	Abpackung Stück	Artikel-Nr.
141	38	128	1 oder 10	155.01.460
173	38	160	1 oder 10	155.01.461
205	38	192	1 oder 10	155.01.462
237	38	224	1 oder 10	155.01.463
301	38	288	1 oder 10	155.01.464
333	38	320	1 oder 10	155.01.465
453	38	440	1 oder 5	155.01.466

DGH-M 2018, HIDE-de, 06/18; Maßangaben unverbindlich. Konstruktionsänderungen vorbehalten.

Gewindeschrauben M4

► MB 1.470

14.08.2019  
ID 4255

1



Möbelgriffe zeitlos

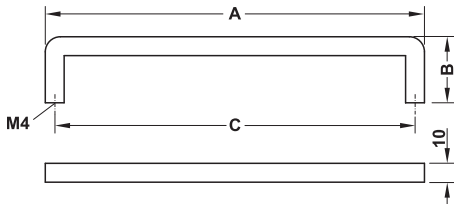
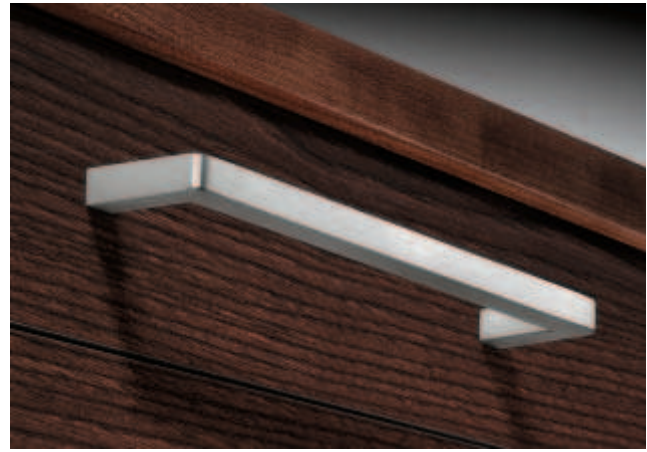

> Werkstoff: Edelstahl, Güte 1.4301/AISI 304  
> Oberfläche: matt gebürstet

Maß A mm	Maß B mm	Maß C mm	Artikel-Nr.
106	35	96	155.01.360
138	35	128	155.01.361
170	35	160	155.01.362
202	35	192	155.01.363
234	35	224	155.01.364
266	35	256	155.01.365
298	35	288	155.01.366
330	35	320	155.01.367

Abpackung: 1 oder 10 Stück

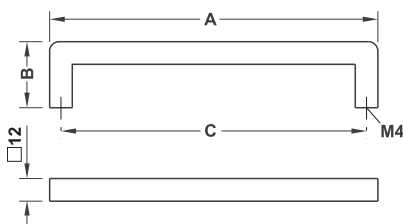

> Werkstoff: Edelstahl, Güte 1.4305/AISI 303  
> Oberfläche: matt gebürstet

Maß A mm	Maß B mm	Maß C mm	Artikel-Nr.
140	40	128	116.11.035
172	40	160	116.11.036
204	40	192	116.11.037

Abpackung: 1 oder 10 Stück

Gewindeschrauben M4

► MB 1.470

DGH-M 2018; HDE-de, 06/18; Maßangaben unverbindlich. Konstruktionsänderungen vorbehalten.

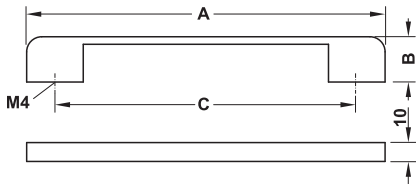

> Werkstoff: Edelstahl, Güte 1.4301/AISI 304  
> Oberfläche: matt gebürstet

Maß A mm	Maß B mm	Maß C mm	Artikel-Nr.
126	24	96	155.01.370
158	24	128	155.01.371
190	24	160	155.01.372

Abpackung: 1 oder 10 Stück

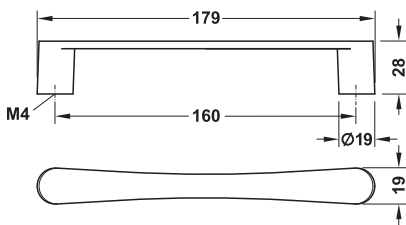

> Werkstoff: Edelstahl, Güte 1.4305/AISI 303

Oberfläche	Artikel-Nr.
matt gebürstet	100.54.013

Abpackung: 1 oder 10 Stück

Gewindeschrauben M4

► MB 1.470

DGH-M 2018, HIDE-de, 06/18; Maßangaben unverbindlich. Konstruktionsänderungen vorbehalten.

14.08.2019  
ID 4255



1

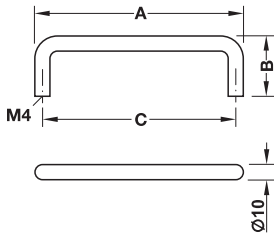

> Oberfläche: schwarz eloxiert

Maß A mm	Maß B mm	Maß C mm	Artikel-Nr.
138	40	128	109.32.880
170	40	160	109.32.881
202	40	192	109.32.882

Abpackung: 1 oder 10 Stück

Möbelgriffe zeitlos

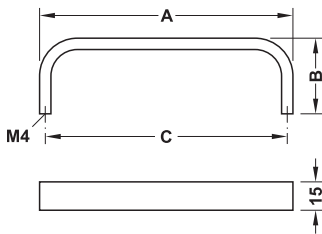

> Oberfläche: schwarz eloxiert

Maß A mm	Maß B mm	Maß C mm	Artikel-Nr.
134	40	128	109.32.870
166	40	160	109.32.871
198	40	192	109.32.872

Abpackung: 1 oder 10 Stück

Gewindeschrauben M4

► MB 1.470

DGH-M 2018; HDE-de, 06/18; Maßangaben unverbindlich. Konstruktionsänderungen vorbehalten.

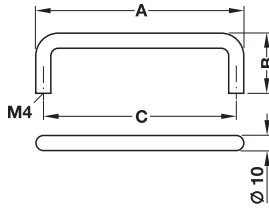

> Werkstoff: Aluminium  
> Oberfläche/Farbe: silberfarben eloxiert

Maß A mm	Maß B mm	Maß C mm	Artikel-Nr.
106	32	96	155.01.020
138	32	128	155.01.021
234	32	224	155.01.022
298	32	288	155.01.023
362	32	352	155.01.024

Abpackung: 1, 50 oder 200 Stück

Möbelgriffe zeitlos

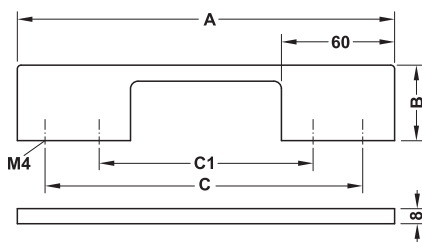

> Oberfläche/Farbe: vernickelt gebürstet

Maß A mm	Maß B mm	Maß C mm	Maß C1 mm	Abpackung Stück	Artikel-Nr.
200	40	170	110	1, 25 oder 100	155.01.060
250	40	220	160	1, 25 oder 50	155.01.061
350	40	320	260	1, 25 oder 50	155.01.062

Gewindeschrauben M4

► MB 1.470

DGH-M 2018, HDE-de, 06/18; Maßangaben unverbindlich. Konstruktionsänderungen vorbehalten.

17.07.2019  
ID 4406

1

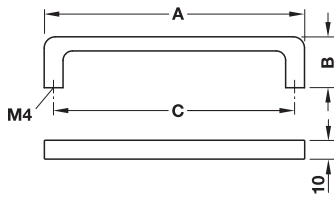

> Oberfläche: silberfarben eloxiert

Maß A mm	Maß B mm	Maß C mm	Abpackung Stück	Artikel-Nr.
106	27	96	1 oder 50	100.74.901
138	27	128	1 oder 40	100.74.902

Möbelgriffe zeitlos

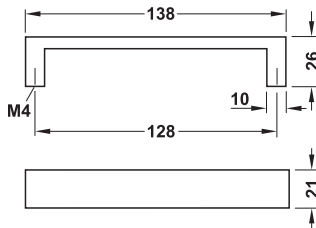

Oberfläche	Artikel-Nr.
silberfarben eloxiert	110.73.904

Abpackung: 1 oder 25 Stück

Gewindeschrauben M4

► MB 1.470

DGH-M 2018; HDE-de, 06/18; Maßangaben unverbindlich. Konstruktionsänderungen vorbehalten.

- > große Griffe als Blickfang
- > können bei ansonsten grifflosen Fronten an schweren Auszügen oder Türen eingesetzt werden (z. B. Apothekeauszug oder Kühlschrank)
- > passend zu verschiedenen Backofengriffen

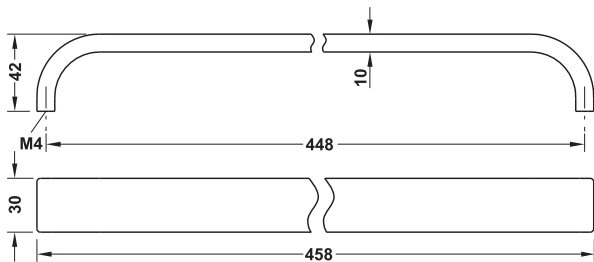

Oberfläche/Farbe	Artikel-Nr.
edelstahlfarben	110.35.638

Abpackung: 1 oder 20 Stück

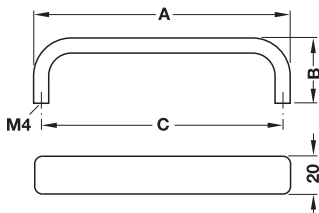

Oberfläche/Farbe	Maß A mm	Maß B mm	Maß C mm	Artikel-Nr.
silberfarben eloxiert	136	35	128	155.01.040
	168	35	160	155.01.041
	200	35	192	155.01.042
	328	35	320	155.01.043
vernickelt gebürstet	136	35	128	155.01.050
	168	35	160	155.01.051
	200	35	192	155.01.052
	328	35	320	155.01.053

Abpackung: 1, 25 oder 100 Stück

DGH-M 2018, HDE-de, 06/18; Maßangaben unverbindlich. Konstruktionsänderungen vorbehalten.

Gewindeschrauben M4

► MB 1.470

1



Möbelgriffe zeitlos

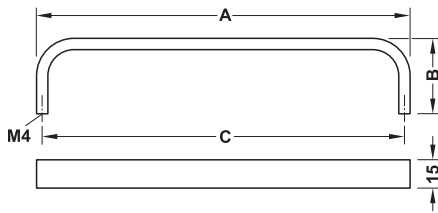

> Oberfläche: matt gebürstet

Maß A mm	Maß B mm	Maß C mm	Artikel-Nr.
134	40	128	116.11.512
166	40	160	116.11.513
198	40	192	116.11.514
230	40	224	116.11.515
294	40	288	116.11.516

Abpackung: 1 oder 10 Stück

passender Möbelknopf ▶ MB 1.274

passende Garderobenhaken ▶ MB 1.437

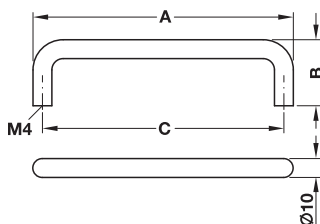

Oberfläche	Maß A mm	Maß B mm	Maß C mm	Artikel-Nr.
poliert	106	35	96	116.35.804
	138	35	128	116.35.840

Abpackung: 1 oder 25 Stück

Gewindeschrauben M4 ▶ MB 1.470

DGH-M 2018; HDE-de, 06/18; Maßangaben unverbindlich. Konstruktionsänderungen vorbehalten.

Modell H1350

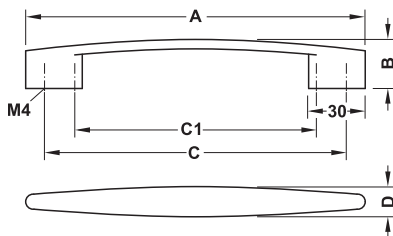

Oberfläche/Farbe	Maß A mm	Maß B mm	Maß C mm	Maß C1 mm	Maß D mm	Artikel-Nr.
verchromt poliert	180	26,5	160	128	16	110.34.236
	244	26	224	192	17,5	110.34.238
vernickelt gebürstet	180	26,5	160	128	16	110.34.636
	244	26	224	192	17,5	110.34.638
weiß, RAL 9016, matt, lackiert	180	26,5	160	128	16	110.34.337
	244	26	224	192	17,5	110.34.339
schwarz, RAL 9017, matt, lackiert	180	26,5	160	128	16	110.34.336
	244	26	224	192	17,5	110.34.338

Abpackung: 1 oder 10 Stück

Gewindeschrauben M4

► MB 1.470

DGH-M 2018, HDE-de, 06/18; Maßangaben unverbindlich. Konstruktionsänderungen vorbehalten.

1  
GAEB  
CAD  
Möbelgriffe zeitlos

1



Möbelgriffe zeitlos

Modell H1385

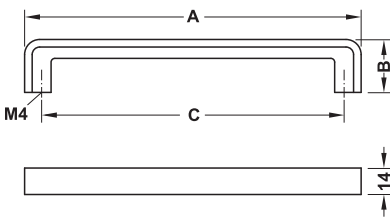
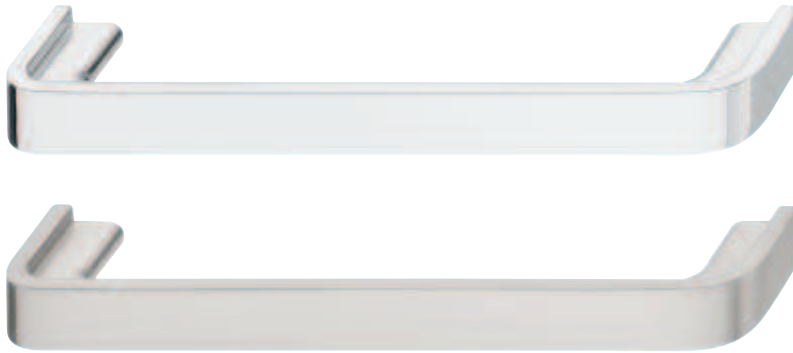

Oberfläche	Maß A mm	Maß B mm	Maß C mm	Artikel-Nr.
verchromt poliert	146	28	128	110.34.265
	178	28	160	110.34.266
	210	28	192	110.34.267
vernickelt gebürstet	146	28	128	110.34.665
	178	28	160	110.34.666
	210	28	192	110.34.667

Abpackung: 1 oder 10 Stück

Gewindeschrauben M4

► MB 1.470

DGH-M 2018; HDE-de, 06/18; Maßangaben unverbindlich. Konstruktionsänderungen vorbehalten.



Modell H1390

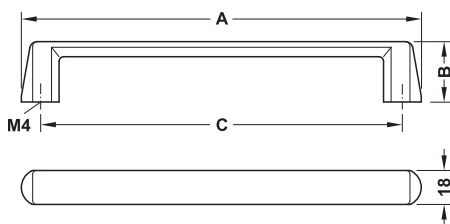

Oberfläche	Maß A mm	Maß B mm	Maß C mm	Artikel-Nr.
verchromt	148	32	128	106.69.205
poliert	212	32	192	106.69.207
vernickelt	148	32	128	106.69.605
gebürstet	212	32	192	106.69.607

Abpackung: 1 oder 25 Stück

Gewindeschrauben M4

► MB 1.470

1



Möbelgriffe zeitlos

Modell H1395

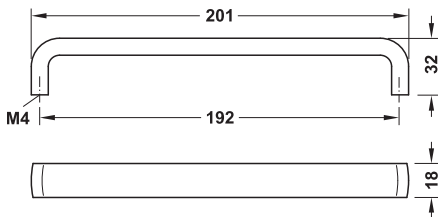
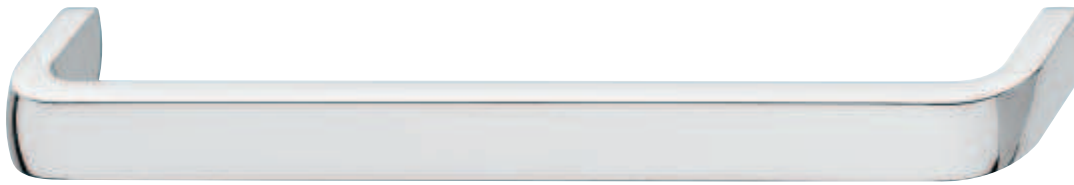

Oberfläche	Artikel-Nr.
verchromt poliert	106.69.237
vernickelt gebürstet	106.69.637

Abpackung: 1 oder 25 Stück

Gewindeschrauben M4

► MB 1.470

DGH-M 2018; HDE-de, 06/18; Maßangaben unverbindlich. Konstruktionsänderungen vorbehalten.

Häfele Design Modell H1950



1

Möbelgriffe zeitlos

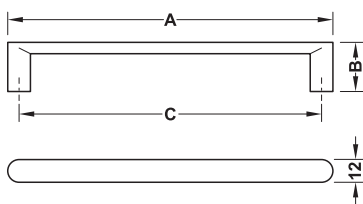
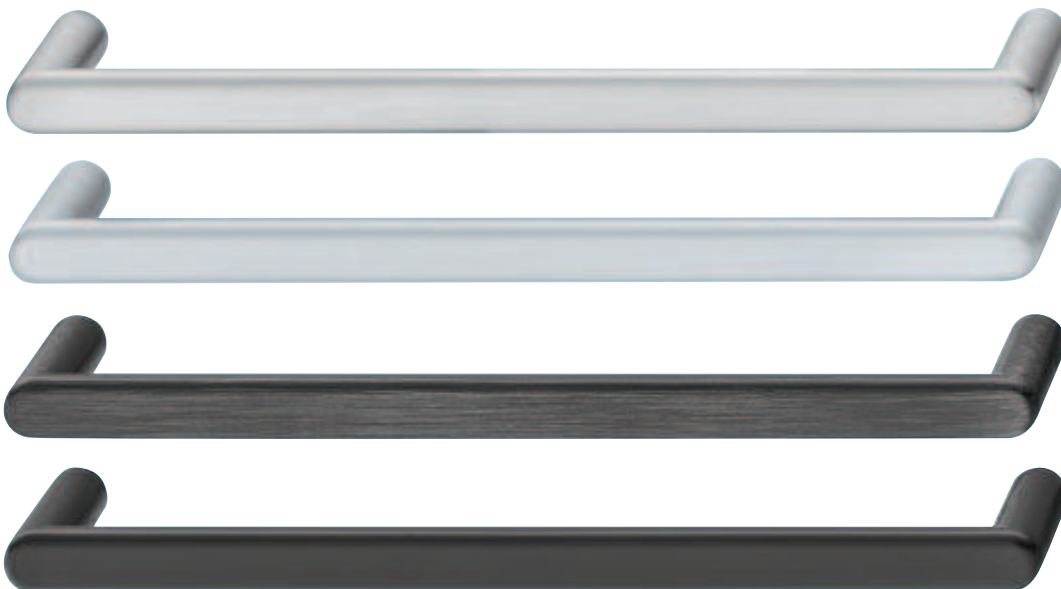

Oberfläche/Farbe	Maß A mm	Maß B mm	Maß C mm	Artikel-Nr.
vernickelt gebürstet	108	26	96	106.69.430
	140	26	128	106.69.431
	172	26	160	106.69.432
	204	26	192	106.69.433
silberfarben	108	26	96	106.69.450
	140	26	128	106.69.451
	172	26	160	106.69.452
	204	26	192	106.69.453
schwarz gebürstet, Used Look	108	26	96	106.69.420
	140	26	128	106.69.421
	172	26	160	106.69.422
	204	26	192	106.69.423
schwarz RAL 9017, matt, lackiert	108	26	96	106.69.440
	140	26	128	106.69.441
	172	26	160	106.69.442
	204	26	192	106.69.443

Abpackung: 1, 10 oder 100 Stück

Gewindeschrauben M4

► MB 1.470

DGH-M 2018, HDE-de, 06/18; Maßangaben unverbindlich. Konstruktionsänderungen vorbehalten.

29.07.2019  
ID 4588

**DIESE SEITE WURDE BEWUSST  
LEER GELASSEN**

**INTENTIONAL BLANK PAGE**

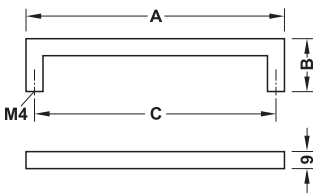

Oberfläche	Maß A mm	Maß B mm	Maß C mm	Abpackung Stück	Artikel-Nr.
verchromt poliert	105	28	96	1 oder 50	155.00.040
	137	28	128	1 oder 20	155.00.041
	169	28	160	1 oder 20	155.00.070
	201	28	192	1 oder 20	155.00.071
	233	28	224	1 oder 20	155.00.072
	329	28	320	1 oder 20	155.00.073
	457	28	448	1 oder 20	155.00.074
verchromt matt	105	28	96	1 oder 50	155.00.050
	137	28	128	1 oder 20	155.00.051
	169	28	160	1 oder 20	155.00.080
	201	28	192	1 oder 20	155.00.081
	233	28	224	1 oder 20	155.00.082
	329	28	320	1 oder 20	155.00.083
	457	28	448	1 oder 20	155.00.084
vernickelt gebürstet	105	28	96	1 oder 50	155.00.060
	137	28	128	1 oder 20	155.00.061
	169	28	160	1 oder 20	155.00.090
	201	28	192	1 oder 20	155.00.091
	233	28	224	1 oder 20	155.00.092
	329	28	320	1 oder 20	155.00.093
	457	28	448	1 oder 20	155.00.094

Gewindeschrauben M4

► MB 1.470

1

Möbelgriffe zeitlos

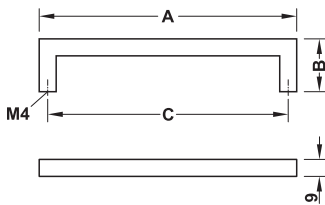

Oberfläche/ Farbe	Maß A mm	Maß B mm	Maß C mm	Abpackung Stück	Artikel-Nr.
schwarz matt, RAL 9017	105	28	96	1, 50 oder 100	155.01.610
	137	28	128	1, 20 oder 100	155.01.611
	169	28	160	1, 20 oder 80	155.01.822
	201	28	192	1, 20 oder 60	155.01.612
	233	28	224	1, 20 oder 60	155.01.613
	329	28	320	1 oder 20	155.01.825
	457	28	448	1 oder 20	155.01.826
vermessingt gebürstet	105	28	96	1, 50 oder 100	155.01.620
	137	28	128	1, 20 oder 100	155.01.621
	169	28	160	1, 20 oder 80	155.02.290
	201	28	192	1, 20 oder 60	155.01.622
	233	28	224	1, 20 oder 60	155.01.623
	329	28	320	1, 20 oder 40	155.02.291
	457	28	448	1 oder 20	155.02.292

Gewindeschrauben M4

► MB 1.470

DGH-M 2018; HDE-de, 06/18; Maßangaben unverbindlich. Konstruktionsänderungen vorbehalten.

**DIESE SEITE WURDE BEWUSST  
LEER GELASSEN**

**INTENTIONAL BLANK PAGE**



1

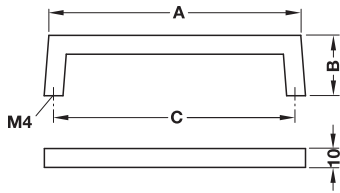

Oberfläche	Maß A mm	Maß B mm	Maß C mm	Artikel-Nr.
verchromt matt	138	32	128	102.12.412
	202	32	192	102.12.414

Abpackung: 1 oder 10 Stück

Möbelgriffe zeitlos

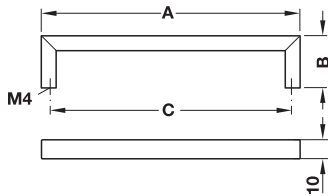

> Oberfläche: verchromt matt

Maß A mm	Maß B mm	Maß C mm	Artikel-Nr.
72	27	64	110.41.401
136	28	128	110.41.403
200	28	192	110.41.405

Abpackung: 1 oder 50 Stück

Gewindeschrauben M4

► MB 1.470

DGH-M 2018; HDE-de, 06/18; Maßangaben unverbindlich. Konstruktionsänderungen vorbehalten.

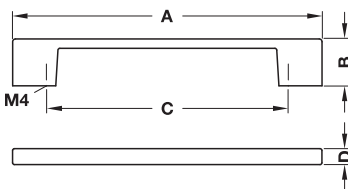

Oberfläche/ Farbe	Maß A mm	Maß B mm	Maß C mm	Maß D mm	Artikel-Nr.
verchromt poliert	132	25	96	8,5	155.00.290
	164	25	128	9	155.00.291
	196	25	160	9	155.00.430
	228	25	192	9	155.00.320
	356	25	320	10	155.00.321
vernickelt matt	132	25	96	8,5	155.00.340
	164	25	128	9	155.00.341
	196	25	160	9	155.00.342
	228	25	192	9	155.00.310
	356	25	320	10	155.00.311
aluminium- farben	132	25	96	8,5	155.00.280
	164	25	128	9	155.00.281
	196	25	160	9	155.00.282
	228	25	192	9	155.00.300
	356	25	320	10	155.00.301
titanfarben, lackiert	132	25	96	8,5	110.29.202
	164	25	128	9	110.29.203
	196	25	160	9	110.29.204
	228	25	192	9	110.29.205
	356	25	320	10	110.29.206

Abpackung: 1 oder 25 Stück

Gewindeschrauben M4

► MB 1.470

DGH-M 2018, HIDE-de, 06/18; Maßangaben unverbindlich. Konstruktionsänderungen vorbehalten.

Möbelgriffe zeitlos

1

Möbelgriffe, Zinkdruckguss

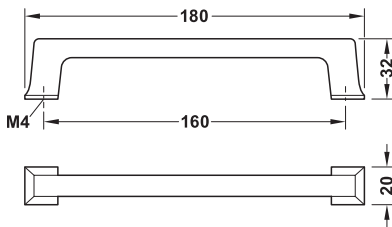

Oberfläche/Farbe	Artikel-Nr.
titanfarben, lackiert	110.29.270
vernickelt, matt	110.29.271

Abpackung: 1 oder 25 Stück

Gewindeschrauben M4

► MB 1.470

DGH-M 2018; HDE-de, 06/18; Maßangaben unverbindlich. Konstruktionsänderungen vorbehalten.

**DIESE SEITE WURDE BEWUSST  
LEER GELASSEN**

**INTENTIONAL BLANK PAGE**

1



Möbelgriffe zeitlos

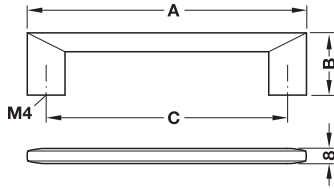

Oberfläche	Maß A mm	Maß B mm	Maß C mm	Artikel-Nr.
vernickelt	148	33	128	110.35.601
gebürstet	212	33	192	110.35.603

Abpackung: 1 oder 25 Stück

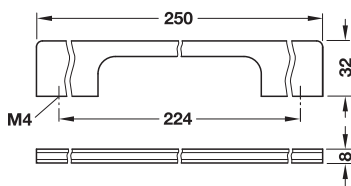

Oberfläche	Artikel-Nr.
verchromt poliert	111.77.205
verchromt matt	111.77.405
vernickelt gebürstet	111.77.615

Abpackung: 1 oder 25 Stück

Gewindeschrauben M4

► MB 1.470

DGH-M 2018; HDE-de, 06/18; Maßangaben unverbindlich. Konstruktionsänderungen vorbehalten.

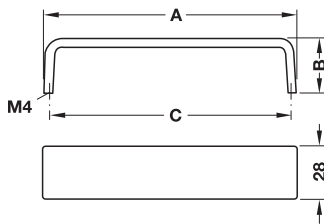

Oberfläche/ Farbe	Maß A mm	Maß B mm	Maß C mm	Artikel-Nr.
verchromt matt	136	30	128	101.13.402
	168	30	160	101.13.403
	200	30	192	101.13.404
aluminium- farben	136	30	128	101.13.906
	168	30	160	101.13.907
	200	30	192	101.13.908
vernickelt gebürstet	136	30	128	101.13.605
	168	30	160	101.13.606
	200	30	192	101.13.607

Abpackung: 1 oder 25 Stück

DGH-M 2018, HIDE-de, 06/18; Maßangaben unverbindlich. Konstruktionsänderungen vorbehalten.

Gewindeschrauben M4

► MB 1.470

1

Dieser Griff mit passendem Beschriftungsclip eignet sich besonders für Medikamenten- und Aktenschränke, Apothekenauszüge und Möbel auf deren Inhalt schnell und zuverlässig zugegriffen werden muss. Eine Beschriftung erspart zeitaufwendiges Suchen. Die weich abgerundeten Griffenden und ein großzügiger Griffraum erlauben ein angenehmes Zugreifen.



Möbelgriffe zeitlos

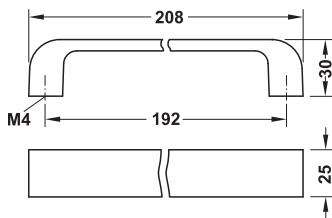

Oberfläche	Artikel-Nr.
verchromt matt	101.13.434
edelstahlfarben	101.13.034

Abpackung: 1 oder 10 Stück

---

passender Beschriftungsclip ▶ MB 1.326

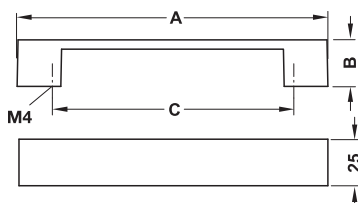
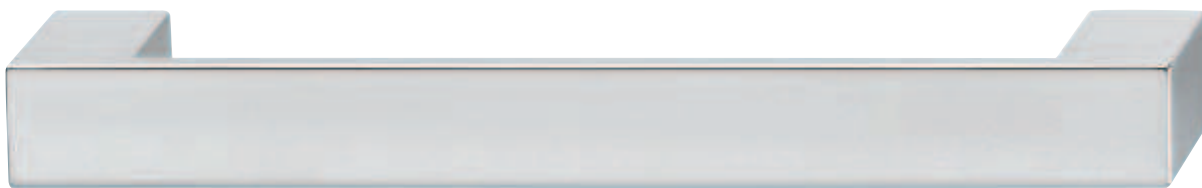

Oberfläche/ Farbe	Maß A mm	Maß B mm	Maß C mm	Abpackung Stück	Artikel-Nr.
verchromt poliert	132	25	96	1 oder 25	155.00.380
	164	25	128	1 oder 25	155.00.140
	196	25	160	1 oder 20	155.00.141
	228	25	192	1 oder 20	155.00.142
vernickelt gebürstet	132	25	96	1 oder 25	155.00.390
	164	25	128	1 oder 25	155.00.150
	196	25	160	1 oder 20	155.00.400
	228	25	192	1 oder 20	155.00.152

Gewindeschrauben M4 ▶ MB 1.470

DGH-M 2018; HDE-de, 06/18; Maßangaben unverbindlich. Konstruktionsänderungen vorbehalten.



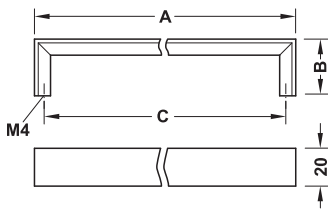

Oberfläche	Maß A mm	Maß B mm	Maß C mm	Abpackung Stück	Artikel-Nr.
verchromt poliert	168	30	160	1 oder 25	109.96.203
	328	30	320	1 oder 5	109.96.208
	488	30	480	1 oder 5	109.96.209
verchromt matt	168	30	160	1 oder 25	109.96.403
	328	30	320	1 oder 5	109.96.408
	488	30	480	1 oder 5	109.96.409
vernickelt matt gebürstet	168	30	160	1 oder 25	109.96.603
	328	30	320	1 oder 5	109.96.608
	488	30	480	1 oder 5	109.96.609

DGH-M 2018, HIDE-de, 06/18; Maßangaben unverbindlich. Konstruktionsänderungen vorbehalten.

Gewindeschrauben M4

► MB 1.470

1



Möbelgriffe zeitlos

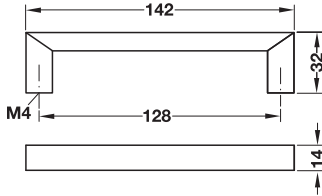

Oberfläche	Artikel-Nr.
verchromt matt	110.52.402

Abpackung: 1 oder 20 Stück

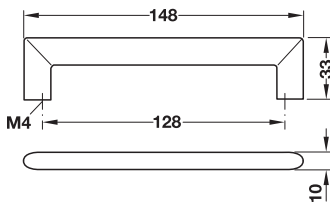

Oberfläche	Artikel-Nr.
verchromt matt	109.59.402

Abpackung: 1 oder 50 Stück

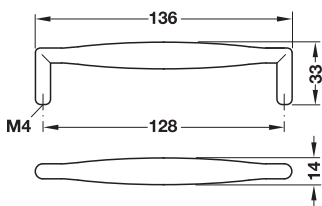

Oberfläche	Artikel-Nr.
edelstahlfarben	102.81.620

Abpackung: 1 oder 10 Stück

Gewindeschrauben M4

► MB 1.470

DGH-M 2018; HDE-de, 06/18; Maßangaben unverbindlich. Konstruktionsänderungen vorbehalten.

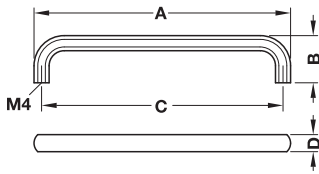

Oberfläche/ Farbe	Maß A mm	Maß B mm	Maß C mm	Maß D mm	Artikel-Nr.
verchromt poliert	104	25	96	9	116.22.236
	136	27	128	10	116.22.235
vernickelt gebürstet	104	25	96	9	116.22.634
	136	27	128	10	116.22.045
vernickelt matt	104	25	96	9	116.22.638
	136	27	128	10	116.22.647
weiß, matt	104	25	96	9	116.22.736
	136	27	128	10	116.22.745
schwarz, matt, pulverbeschichtet	104	25	96	9	116.22.334
	136	27	128	10	116.22.343

Abpackung: 1 oder 25 Stück

1



Möbelgriffe zeitlos

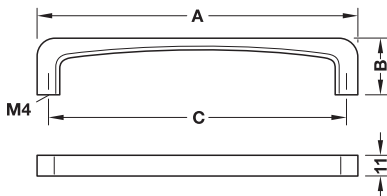

Oberfläche/ Farbe	Maß A mm	Maß B mm	Maß C mm	Artikel-Nr.
verchromt	170	30	160	110.29.256
poliert	330	30	320	110.29.259
vernickelt gebürstet	170	30	160	110.29.656
	202	30	192	110.29.057
vergoldet, matt	330	30	320	110.29.659
	170	30	160	110.29.260
titanfarben, lackiert	330	30	320	110.29.261
	170	30	160	110.29.556
schwarz, matt	202	30	192	110.29.557
	170	30	160	110.29.356
	202	30	192	110.29.357
	330	30	320	110.29.358

Abpackung: 1 oder 25 Stück

Gewindeschrauben M4

► MB 1.470

DGH-M 2018; HDE-de, 06/18; Maßangaben unverbindlich. Konstruktionsänderungen vorbehalten.

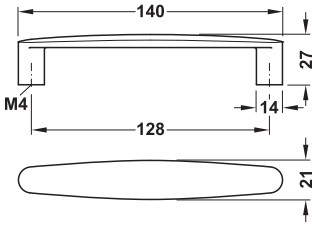

Oberfläche	Artikel-Nr.
verchromt matt	155.00.180
vernickelt matt	155.00.190

Abpackung: 1 oder 25 Stück

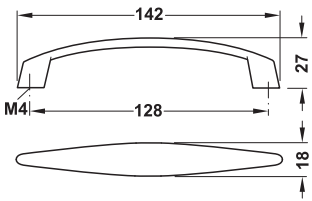

Oberfläche	Artikel-Nr.
verchromt matt	155.00.160
vernickelt matt	155.00.170

Abpackung: 1 oder 25 Stück

DGH-M 2018, HIDE-de, 06/18; Maßangaben unverbindlich. Konstruktionsänderungen vorbehalten.

Gewindeschrauben M4

► MB 1.470

1



Möbelgriffe zeitlos

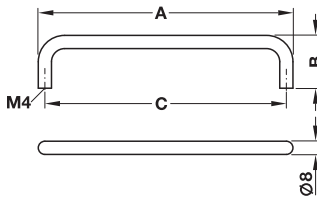

Oberfläche	Maß A mm	Maß B mm	Maß C mm	Abpackung Stück	Artikel-Nr.
verchromt poliert	72	35	64	1 oder 25	155.00.890
	104	35	96	1 oder 25	155.00.891
	136	35	128	1 oder 25	155.00.892
	168	35	160	1 oder 25	155.00.893
	200	35	192	1 oder 25	155.00.894
	264	35	256	1 oder 25	155.00.895
verchromt matt	72	35	64	1 oder 25	155.00.900
	104	35	96	1 oder 25	155.00.901
	136	35	128	1 oder 25	155.00.902
	168	35	160	1 oder 10	155.00.903
	200	35	192	1 oder 10	155.00.904
	264	35	256	1 oder 10	155.00.905
vernickelt matt	72	35	64	1 oder 25	155.00.910
	104	35	96	1 oder 25	155.00.911
	136	35	128	1 oder 25	155.00.912
	168	35	160	1 oder 10	155.00.913
	200	35	192	1 oder 10	155.00.914
	264	35	256	1 oder 10	155.00.915
vernickelt gebürstet	72	35	64	1 oder 25	155.00.920
	104	35	96	1 oder 25	155.00.921
	104	35	128	1 oder 25	155.00.922
	168	35	160	1 oder 10	155.00.923
	200	35	192	1 oder 10	155.00.924
	264	35	256	1 oder 10	155.00.925

passende Rosette ▶ MB 1.184

Gewindeschrauben M4 ▶ MB 1.470

DGH-M 2018; HDE-de, 06/18; Maßangaben unverbindlich. Konstruktionsänderungen vorbehalten.

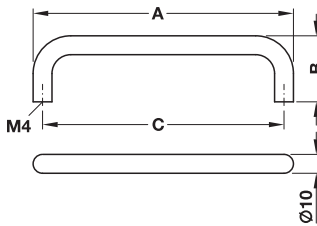

Oberfläche	Maß A mm	Maß B mm	Maß C mm	Abpackung Stück	Artikel-Nr.
verchromt poliert	74	35	64	1 oder 25	155.00.930
	106	35	96	1 oder 20	155.00.931
	138	35	128	1 oder 15	155.00.932
	170	35	160	1 oder 15	155.00.933
	202	35	192	1 oder 20	155.00.934
	298	35	288	1 oder 20	155.00.935
	362	35	352	1 oder 10	155.00.936
verchromt matt	74	35	64	1 oder 20	155.00.940
	106	35	96	1 oder 25	155.00.941
	138	35	128	1 oder 25	155.00.942
	170	35	160	1 oder 25	155.00.943
	202	35	192	1 oder 10	155.00.944
	298	35	288	1 oder 10	155.00.945
	362	35	352	1 oder 10	155.00.946
vernickelt matt	74	35	64	1 oder 20	155.00.950
	106	35	96	1 oder 25	155.00.951
	138	35	128	1 oder 25	155.00.952
	170	35	160	1 oder 25	155.00.953
	202	35	192	1 oder 10	155.00.954
	266	35	256	1 oder 10	155.00.955
	298	35	288	1 oder 10	155.00.956
vernickelt gebürstet	330	35	320	1 oder 10	155.00.957
	362	35	352	1 oder 10	155.00.958
	74	35	64	1 oder 20	155.00.370
	106	35	96	1 oder 25	155.00.371
	138	35	128	1 oder 25	155.00.372
	170	35	160	1 oder 25	155.00.373
	202	35	192	1 oder 10	155.00.374
298	35	288	1 oder 10	155.00.375	
362	35	352	1 oder 10	155.00.376	

Möbelgriffe zeitlos

DGH-M 2018, HIDE-de, 06/18; Maßangaben unverbindlich. Konstruktionsänderungen vorbehalten.

Gewindeschrauben M4

► MB 1.470



1



Möbelgriffe zeitlos

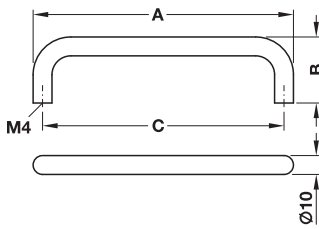

Oberfläche/ Farbe	Maß A mm	Maß B mm	Maß C mm	Artikel-Nr.
goldfarben, poliert	106	35	96	116.09.815
	138	35	128	116.09.885
weiß, glänzend lackiert	106	35	96	116.09.714
	138	35	128	116.09.785
schwarz, matt lackiert	170	35	160	116.09.345

Abpackung: 1 oder 25 Stück

Rosette

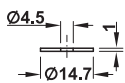

> Werkstoff: Messing

Oberfläche	Artikel-Nr.
vernickelt matt	116.06.698
vernickelt poliert	116.06.796

Abpackung: 1 oder 50 Stück

Gewindeschrauben M4

► MB 1.470

DGH-M 2018; HDE-de, 06/18; Maßangaben unverbindlich. Konstruktionsänderungen vorbehalten.

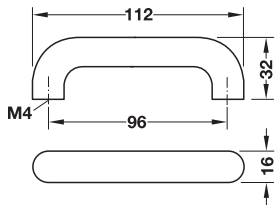

> Oberfläche: natur

Werkstoff	Artikel-Nr.
Buche	193.34.342
Kiefer	193.34.042

Abpackung: 1 oder 25 Stück

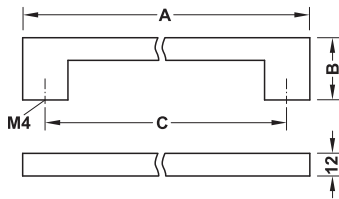

> Oberfläche: natur

Werkstoff	Maß A mm	Maß B mm	Maß C mm	Artikel-Nr.
Eiche	184	33	160	193.12.403
	120	33	96	191.67.060

Abpackung: 1 oder 25 Stück

DGH-M 2018, HIDE-de, 06/18; Maßangaben unverbindlich. Konstruktionsänderungen vorbehalten.

Gewindeschrauben M4

► MB 1.470

1



> Werkstoff: Polyamid

Maß A mm	Maß B mm	Maß C mm	verfügbare Farben ab Lager	Artikel-Nr.
42	26	32	33, 90, 99	114.21.1**
50	30	40	99	114.21.2**

Abpackung: 1 Stück

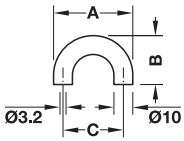

Möbelgriffe zeitlos

18 senfgelb	24 orange	33 rubinrot	36 koralle	50 stahlblau	55 aquablau	72 maigrün
74 apfelgrün	84 umbra	86 sand	90 tiefschwarz	92 anthrazitgrau	95 felsgrau	97 lichtgrün
98 signalweiß	99 reinweiß					

Panheadschrauben Hospa Ø 4 mm

► MB 1.470



Farbe	Artikel-Nr.
weiß	116.52.725
schwarz	116.52.323

Abpackung: 1 oder 100 Stück

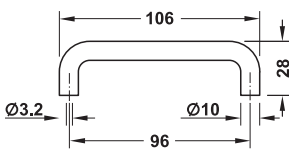

Panheadschrauben Hospa Ø 3,5 mm

► MB 1.470

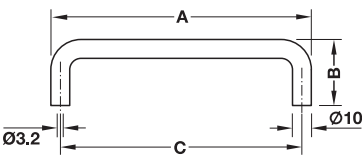
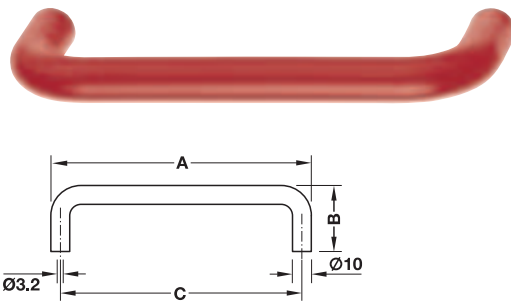

> Werkstoff: Polyamid

Maß A mm	Maß B mm	Maß C mm	verfügbare Farben ab Lager	Artikel-Nr.
<b>glänzend</b>				
74	32	64	90, 99	114.20.1**
106	35	96	33, 50, 90, 95, 97, 99	114.20.5**
138	35	128	33, 50, 90, 92, 95, 97, 99	114.20.7**
<b>matt</b>				
106	35	96	–	114.20.0**
138	35	128	–	114.20.9**

Abpackung: 1 oder 25 Stück

DGH-M 2018, HDE-de, 06/18; Maßangaben unverbindlich. Konstruktionsänderungen vorbehalten.

<b>18</b> senfgelb	<b>24</b> orange	<b>33</b> rubinrot	<b>36</b> koralle	<b>50</b> stahlblau	<b>55</b> aquablau	<b>72</b> maigrün
<b>74</b> apfelgrün	<b>84</b> umbra	<b>86</b> sand	<b>90</b> tiefschwarz	<b>92</b> anthrazitgrau	<b>95</b> felsgrau	<b>97</b> lichtgrau
<b>98</b> signalweiß	<b>99</b> reinweiß					

Panheadschrauben Hospa Ø 4,0 mm

► MB 1.470

21.02.2019  
ID 4191

1

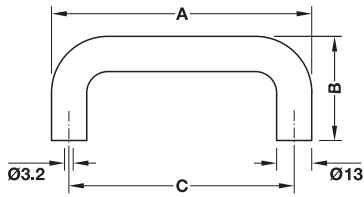

> Werkstoff: Polyamid

Maß A mm	Maß B mm	Maß C mm	verfügbare Farben ab Lager	Artikel-Nr.
<b>glänzend</b>				
109	38	96	33, 50, 90, 92, 95, 97, 99	114.22.2**
141	38	128	33, 50, 90, 92, 95, 97, 99	114.22.3**
205	38	192	33, 90, 95, 97, 99	114.22.4**
<b>matt</b>				
109	38	96	–	114.22.0**

Abpackung: 1 oder 25 Stück

Möbelgriffe zeitlos

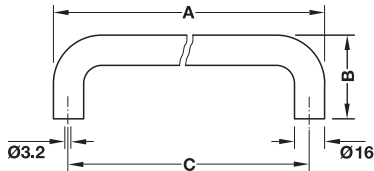

> Werkstoff: Polyamid

Maß A mm	Maß B mm	Maß C mm	verfügbare Farben ab Lager	Artikel-Nr.
208	44	192	33, 92, 95	114.23.4**
304	44	288	33, 90, 95, 99	114.23.5**

Abpackung: 1 Stück

**Bestellhinweis**

Bei Bestellung ersetzen Sie bitte die \*\* durch die Farb-Nummer Ihrer Wahl.



Panheadschrauben Hospa Ø 4,0 mm

► MB 1.470

DGH-M 2018; HDE-de, 06/18; Maßangaben unverbindlich. Konstruktionsänderungen vorbehalten.

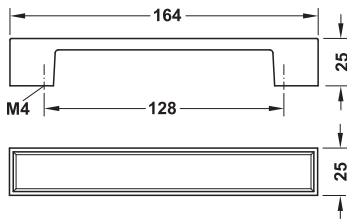

> Werkstoff: Griff: Zinkdruckguss,  
Einlage: Glas

Oberfläche	Artikel-Nr.
Griff: verchromt poliert Einlage: weiß	109.50.274

Abpackung: 1 oder 10 Stück

DGH-M 2018, HIDE-de, 06/18; Maßangaben unverbindlich. Konstruktionsänderungen vorbehalten.

passender Möbelknopf ▶ MB 1.287

Gewindeschrauben M4 ▶ MB 1.470

Möbelgriff Durchmesser 10 mm

1

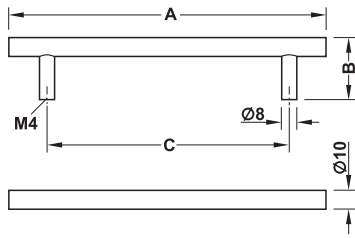

> Werkstoff: Edelstahl, Güte 1.4301/AISI 304  
> Oberfläche: matt gebürstet

Maß A mm	Maß B mm	Maß C mm	Abpackung Stück	Artikel-Nr.
136	35	96	1 oder 30	155.01.380
168	35	128	1 oder 20	155.01.381
200	35	160	1 oder 20	155.01.382
232	35	192	1 oder 20	155.01.383
264	35	224	1 oder 20	155.01.384
328	35	288	1 oder 15	155.01.385
360	35	320	1 oder 10	155.01.386
392	35	352	1 oder 10	155.01.387
488	35	448	1 oder 10	155.01.388
600	35	560	1 oder 10	155.01.389
700	35	660	1 oder 8	155.01.390
800	35	760	1 oder 8	155.01.391

Möbelgriffe zeitlos

Gewindeschrauben M4

► MB 1.470

DGH-M 2018, HDE-de, 06/18; Maßangaben unverbindlich. Konstruktionsänderungen vorbehalten.



Möbelgriff Durchmesser 12 mm

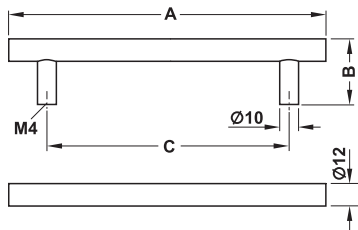

> Werkstoff: Edelstahl, Güte 1.4301/AISI 304

Oberfläche/Farbe	Maß A mm	Maß B mm	Maß C mm	Abpackung Stück	Artikel-Nr.
matt gebürstet	136	35	96	1 oder 20	155.01.400
	168	35	128	1 oder 10	155.01.401
	200	35	160	1 oder 10	155.01.402
	232	35	192	1 oder 10	155.01.403
	264	35	224	1 oder 10	155.01.404
	296	35	256	1 oder 10	155.01.414
	328	35	288	1 oder 10	155.01.405
	360	35	320	1 oder 10	155.01.406
	392	35	352	1 oder 10	155.01.407
	488	35	448	1 oder 10	155.01.408
	500	35	460	1 oder 8	155.01.410
	600	35	560	1 oder 5	155.01.411
	700	35	660	1 oder 5	155.01.412
800	35	760	1 oder 5	155.01.409	
1000	35	960	1 oder 5	155.01.413	
vermessingt poliert, PVD beschichtet	136	35	96	1 oder 20	112.04.060
	168	35	128	1 oder 10	112.04.061
schwarz, matt, PVD beschichtet	136	35	96	1 oder 20	112.04.062
	168	35	128	1 oder 10	112.04.063

Möbelgriffe zeitlos

DGH-M 2018, HIDE-de, 06/18; Maßangaben unverbindlich. Konstruktionsänderungen vorbehalten.

Gewindeschrauben M4

► MB 1.470

14.08.2019  
ID 4255

Möbelgriff Durchmesser 12 mm

1

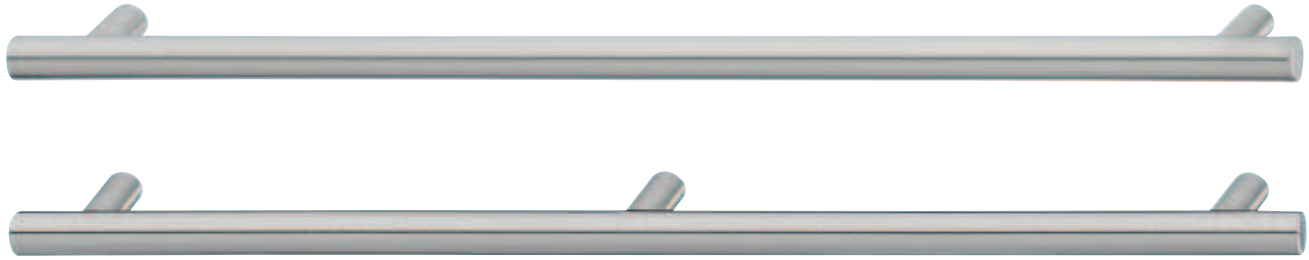

Möbelgriffe zeitlos

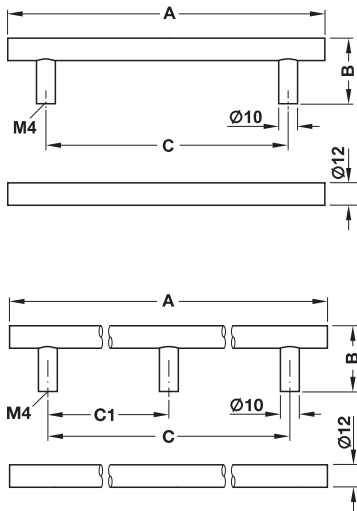

> Werkstoff: Edelstahl, Güte 1.4305  
> Oberfläche: matt gebürstet

Korpusbreite mm	Maß A mm	Maß B mm	Maß C1 mm	Maß C mm	Ab- packung Stück	Artikel-Nr.
<b>mit 2 Sockeln</b>						
–	136	35	–	96	1 oder 10	117.66.017
–	168	35	–	128	1 oder 10	117.66.026
300	200	35	–	160	1 oder 10	117.66.035
–	232	35	–	192	1 oder 10	117.66.044
350	250	35	–	210	1 oder 10	117.66.045
400	300	35	–	260	1 oder 10	117.66.050
–	328	35	–	288	1 oder 10	117.66.053
450	350	35	–	310	1 oder 10	117.66.055
–	392	35	–	352	1 oder 10	117.66.062
500	400	35	–	360	1 oder 10	117.66.064
550	450	35	–	410	1 oder 10	117.66.065
–	488	35	–	448	1 oder 10	117.66.071
600	500	35	–	460	1	117.66.075
700	600	35	–	560	1	117.66.080
800	700	35	–	660	1	117.66.085
900	800	35	–	760	1	117.66.090
1000	900	35	–	860	1	117.66.095
<b>mit 3 Sockeln</b>						
–	1000	35	480	960	1	117.66.100
–	1100	35	530	1060	1	117.66.101
–	1200	35	580	1160	1	117.66.102
–	1300	35	630	1260	1	117.66.103
–	1400	35	680	1360	1	117.66.104
–	1500	35	730	1460	1	117.66.106
–	1600	35	780	1560	1	117.66.107
–	1800	35	880	1760	1	117.66.108
–	2000	35	980	1960	1	117.66.109

**Kundenindividuelle Topco-Leistungen**  
Andere Größen und Ausführungen sind als Topco-Leistung lieferbar.

Topco-Leistungen ▶ MB 1.193  
Gewindeschrauben M4 ▶ MB 1.470

DGH-M 2018; HDE-de, 06/18; Maßangaben unverbindlich. Konstruktionsänderungen vorbehalten.

Möbelgriff Durchmesser 12 mm – Topco

1

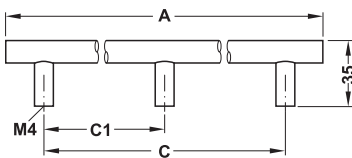
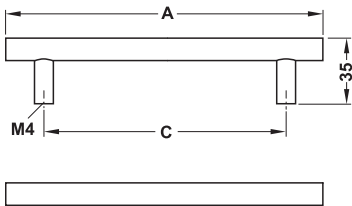
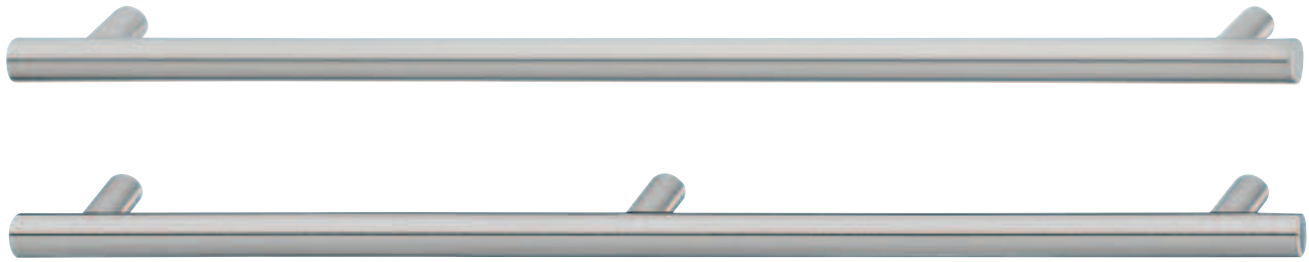

**topCo** KUNDENINDIVIDUELL  
BEREITS AB EINEM STÜCK

Folgende Eigenschaften können Sie wählen:

- > Grifflänge (Maß A)
- > Lochabstand (Maß C, ggf. C1)
- > Stangendurchmesser
- > Sockeldurchmesser
- > Anzahl Sockel
- > Edelstahlgüte 1.4305 oder 1.4571

> Oberfläche: matt gebürstet

Länge mm	Werkstoff	Artikel-Nr.
Fixlänge (bis 2.400 mm)	Edelstahl, Güte 1.4305	117.66.019
	Edelstahl, Güte 1.4571	117.64.099

Abpackung: 1 Stück

**Hinweis**

Dieser Griff ist in folgenden Varianten lieferbar.

Werkstoff	Stangen- durchmesser mm	Sockel- durchmesser mm
Edelstahl, Güte 1.4305	12, 14, 16, 18, 20	8, 10
Edelstahl, Güte 1.4571	12, 14	10

**Bestellhinweis**

Zur Stabilisierung sind erforderlich

- > ab Länge 1.000 mm: 3 Sockel
- > ab Länge 1.600 mm: 4 Sockel

Standardmaße	► MB 1.192
Gewindeschrauben M4	► MB 1.470

Möbelgriffe zeitlos

Möbelgriff Durchmesser 14 mm

1



Möbelgriffe zeitlos

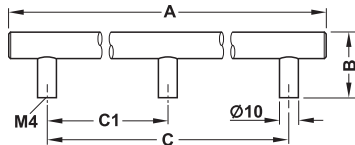
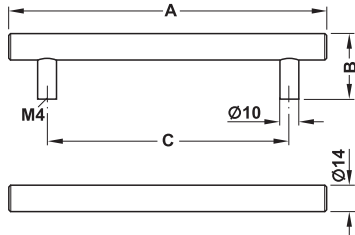
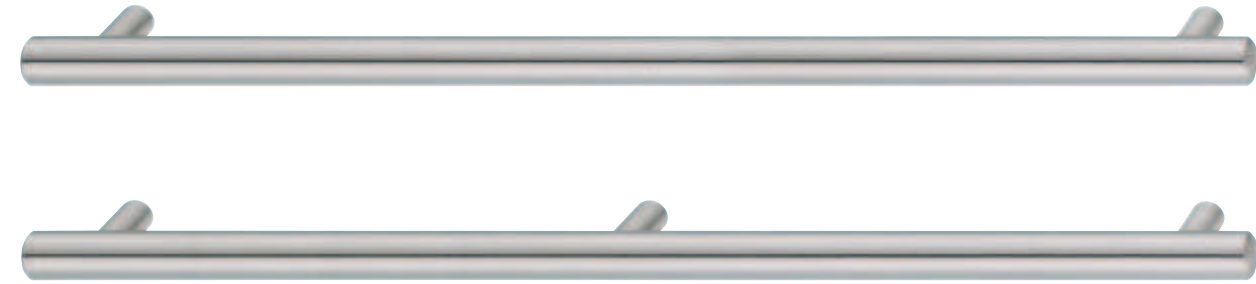

**Kundenindividuelle Topco-Leistungen**  
Andere Größen und Ausführungen sind als Topco-Leistung lieferbar.

**topCo KUNDENINDIVIDUELL**  
BEREITS AB EINEM STÜCK

- Folgende Eigenschaften können Sie wählen:
- > Grifflänge (Maß A)
  - > Lochabstand (Maß C, ggf. C1)
  - > Anzahl Sockel

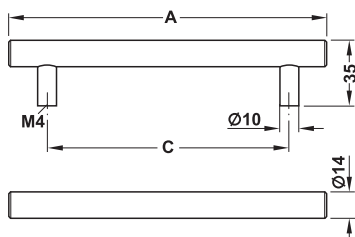

- > Werkstoff: Edelstahl, Güte 1.4305
- > Oberfläche: matt gebürstet

Korpusbreite mm	Maß A mm	Maß B mm	Maß C1 mm	Maß C mm	Abpackung Stück	Artikel-Nr.
<b>mit 2 Sockeln</b>						
–	136	35	–	96	1 oder 10	115.48.601
–	168	35	–	128	1 oder 10	115.48.602
300	200	35	–	160	1 oder 10	115.48.603
–	232	35	–	192	1 oder 10	115.48.604
350	250	35	–	210	1 oder 10	115.48.605
400	300	35	–	260	1 oder 10	115.48.606
–	328	35	–	288	1 oder 10	115.48.607
450	350	35	–	310	1 oder 10	115.48.608
–	392	35	–	352	1 oder 10	115.48.609
500	400	35	–	360	1 oder 10	115.48.610
550	450	35	–	410	1 oder 10	115.48.611
600	500	35	–	460	1 oder 10	115.48.613
700	600	35	–	560	1 oder 10	115.48.614
800	700	35	–	660	1 oder 10	115.48.615
900	800	35	–	760	1 oder 10	115.48.616
1000	900	35	–	860	1	115.48.617

<b>mit 3 Sockeln</b>						
–	1000	35	480	960	1	115.48.618
–	1100	35	530	1060	1	115.48.619
–	1200	35	580	1160	1	115.48.620
–	1600	35	780	1560	1	115.48.625
–	1800	35	880	1760	1	115.48.626

Länge mm	Artikel-Nr.
Fixlänge (bis 2.000 mm)	115.48.629

Abpackung: 1 Stück

**Bestellhinweis**

- Zur Stabilisierung sind erforderlich
- > ab Länge 800 mm: 3 Sockel
  - > ab Länge 1.600 mm: 4 Sockel

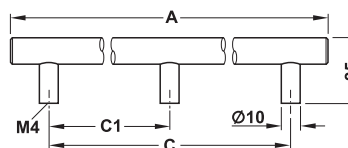

Gewindeschrauben M4

► MB 1.470

DGH-M 2018; HDE-de, 06/18; Maßangaben unverbindlich. Konstruktionsänderungen vorbehalten.

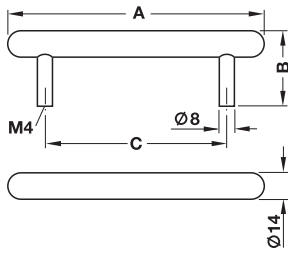

> Werkstoff: Edelstahl, Güte 1.4301/AISI 304  
> Oberfläche: matt gebürstet

Maß A mm	Maß B mm	Maß C mm	Abpackung Stück	Artikel-Nr.
136	37	96	1 oder 20	155.01.420
168	37	128	1 oder 15	155.01.421
200	37	160	1 oder 15	155.01.422
232	37	192	1 oder 15	155.01.423
264	37	224	1 oder 10	155.01.424
360	37	320	1 oder 8	155.01.425
488	37	448	1 oder 8	155.01.426
520	37	480	1 oder 5	155.01.427
712	37	672	1 oder 5	155.01.428
936	37	896	1 oder 5	155.01.429
1192	37	1152	1 oder 4	155.01.430

Möbelgriffe zeitlos

DGH-M 2018, HIDE-de, 06/18; Maßangaben unverbindlich. Konstruktionsänderungen vorbehalten.

Gewindeschrauben M4

► MB 1.470

14.08.2019  
ID 4255

1



Möbelgriffe zeitlos

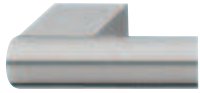
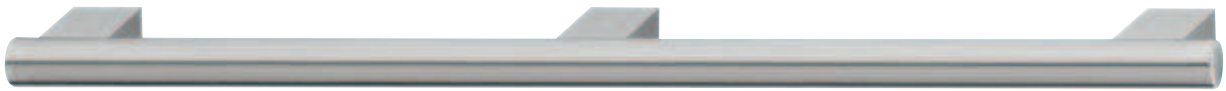

Montage-Variante

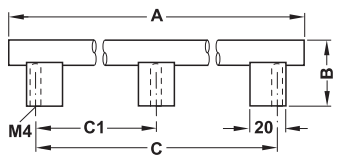
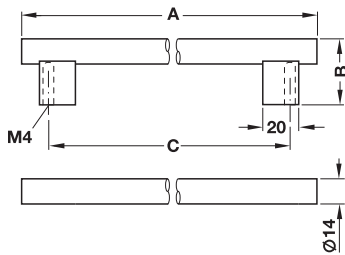

### Kundenindividuelle Topco-Leistungen

Andere Größen und Ausführungen sind als Topco-Leistung lieferbar



Folgende Eigenschaften können Sie wählen:

- > Grifflänge (Maß A)
- > Lochabstand (Maß C, ggf. C1)
- > Anzahl Sockel

Diese Griffe sind auch mit einer Logo-Beschriftung an der Stirnseite des Griffes (bis max. Lochabstand 192 mm) und an den Sockeln erhältlich.

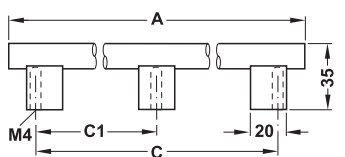
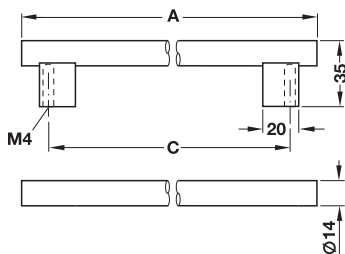

- > Werkstoff: Edelstahl, Güte 1.4305
- > Oberfläche: matt gebürstet
- > Ausführung: mit fest montierter Gewindehülse, Sockel lose, Sockelbohrung außerhalb der Mitte, dadurch 2 Möbelgriffvarianten möglich

Korpusbreite mm	Maß A mm	Maß B mm	Maß C1 mm	Maß C mm	Artikel-Nr.
<b>mit 2 Sockeln</b>					
–	126	35	–	96	100.43.001
–	158	35	–	128	100.43.002
300	190	35	–	160	100.43.003
–	222	35	–	192	100.43.004
350	240	35	–	210	100.43.005
400	290	35	–	260	100.43.006
–	318	35	–	288	100.43.007
450	340	35	–	310	100.43.008
–	382	35	–	352	100.43.009
500	390	35	–	360	100.43.010
550	440	35	–	410	100.43.011
–	478	35	–	448	100.43.012
600	490	35	–	460	100.43.013
700	590	35	–	560	100.43.014
800	690	35	–	660	100.43.015
<b>mit 3 Sockeln</b>					
900	790	35	380	760	100.43.016
1000	890	35	430	860	100.43.017
–	990	35	480	960	100.43.018

Abpackung: 1 oder 10 Stück

Länge mm	Artikel-Nr.
Fixlänge (bis 2.400 mm)	100.43.019

Abpackung: 1 Stück

### Bestellhinweis

Zur Stabilisierung sind erforderlich

- > ab Länge 800 mm: 3 Sockel
- > ab Länge 1.600 mm: 4 Sockel

Laser-Beschriftung ▶ MB 1.206

Gewindeschrauben M4 ▶ MB 1.470

DGH-M 2018; HDE-de, 06/18; Maßangaben unverbindlich. Konstruktionsänderungen vorbehalten.

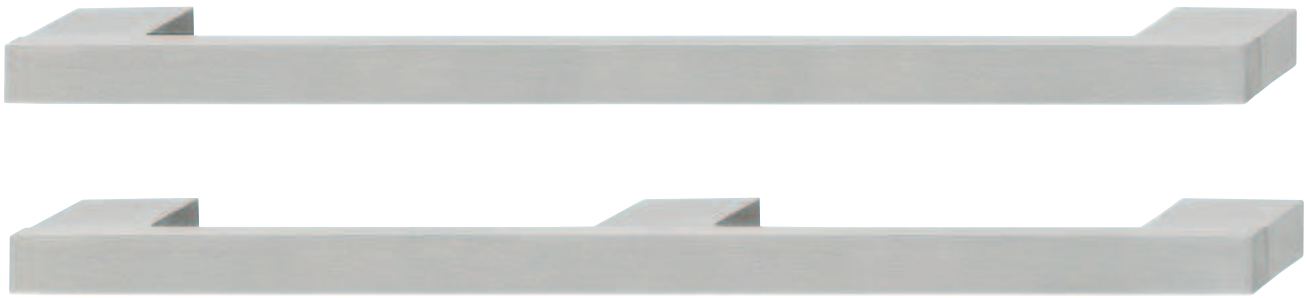

Lieferbar auch für gängige Standardkorpusbreiten

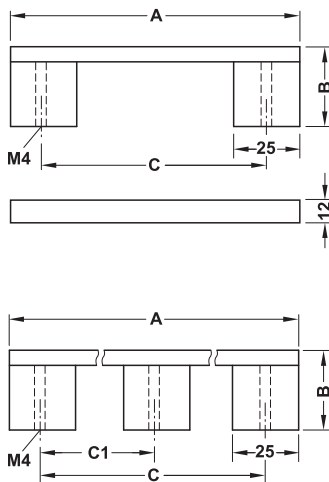

- > Werkstoff: Edelstahl, Güte 1.4305
- > Oberfläche: matt gebürstet
- > Ausführung: mit fest montierter Gewindehülse, Rechtecksockel lose

Korpusbreite mm	Maß A mm	Maß B mm	Maß C1 mm	Maß C mm	Artikel-Nr.
<b>mit 2 Sockeln</b>					
–	121	35	–	96	100.66.001
–	153	35	–	128	100.66.002
–	185	35	–	160	100.66.003
–	217	35	–	192	100.66.004
–	249	35	–	224	100.66.005
–	313	35	–	288	100.66.007
–	345	35	–	320	100.66.008
–	377	35	–	352	100.66.009
–	473	35	–	448	100.66.012
600	485	35	–	460	100.66.011
700	585	35	–	560	100.66.013
800	685	35	–	660	100.66.014
<b>mit 3 Sockeln</b>					
900	785	35	380	760	100.66.015
1000	885	35	430	860	100.66.016
1100	985	35	480	960	100.66.017

Abpackung: 1 oder 10 Stück

**Kundenindividuelle Topco-Leistungen**  
Andere Größen und Ausführungen sind als Topco-Leistung lieferbar.

**topCo** KUNDENINDIVIDUELL  
BEREITS AB EINEM STÜCK

Diese Griffe sind auch mit einer Logo-Beschriftung an der Stirnseite des Griffes (bis max. Lochabstand 192 mm) und an den Sockeln erhältlich.



Anwendungsbeispiel Laser-Beschriftung

Topco-Leistungen	► MB 1.198
Laser-Beschriftung	► MB 1.206
Gewindeschrauben M4	► MB 1.470

DGH-M 2018, HIDE-de, 06/18; Maßangaben unverbindlich. Konstruktionsänderungen vorbehalten.



Möbelgriff – Topco

1



Möbelgriffe zeitlos

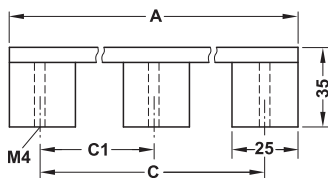
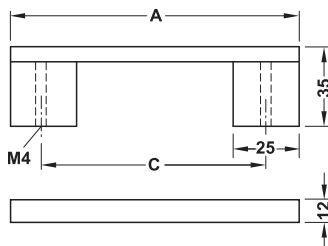
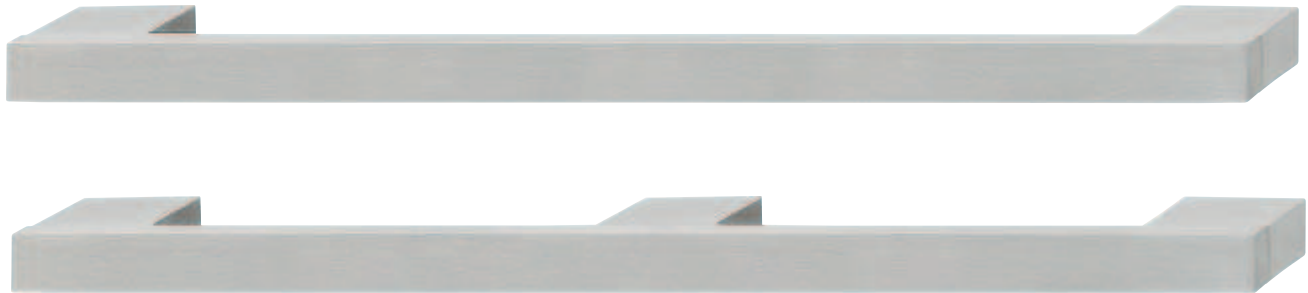

- > Werkstoff: Edelstahl, Güte 1.4305
- > Oberfläche: matt gebürstet
- > Ausführung: mit fest montierter Gewindehülse, Rechtecksockel lose

Länge mm	Artikel-Nr.
Fixlänge (bis 2.000 mm)	100.66.019

Abpackung: 1 Stück

**Bestellhinweis**

- Zur Stabilisierung sind erforderlich
- > ab Länge 800 mm: 3 Sockel
  - > ab Länge 1.400 mm: 4 Sockel
  - > bei Länge 2.000 mm: 5 Sockel

**topCo** KUNDENINDIVIDUELL  
BEREITS AB EINEM STÜCK

- Folgende Eigenschaften können Sie wählen:
- > Grifflänge (Maß A)
  - > Lochabstand (Maß C, ggf. C1)
  - > Anzahl Sockel

Diese Griffe sind auch mit einer Logo-Beschriftung an der Stirnseite des Griffes (bis max. Lochabstand 192 mm) und an den Sockeln erhältlich.



Anwendungsbeispiel Laser-Beschriftung

Standardmaße	► MB 1.197
Laser-Beschriftung	► MB 1.206
Gewindeschrauben M4	► MB 1.470

Möbelgriff

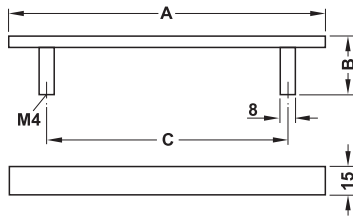

**Kundenindividuelle Topco-Leistungen**  
Andere Größen und Ausführungen sind als Topco-Leistung lieferbar.

> Werkstoff: Edelstahl, Güte 1.4305  
> Oberfläche: matt gebürstet

Maß A mm	Maß B mm	Maß C mm	Artikel-Nr.
136	31	96	115.67.602
168	31	128	115.67.603
200	31	160	115.67.604
232	31	192	115.67.605

Abpackung: 1 oder 10 Stück

Möbelgriff – Topco

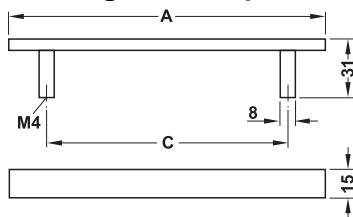

> Werkstoff: Edelstahl, Güte 1.4305  
> Oberfläche: matt gebürstet

Länge mm	Artikel-Nr.
Fixlänge (bis 2.000 mm)	115.67.609

Abpackung: 1 Stück

**topCo** KUNDENINDIVIDUELL  
BEREITS AB EINEM STÜCK

Folgende Eigenschaften können Sie wählen:

- > Grifflänge (Maß A)
- > Lochabstand (Maß C, ggf. C1)
- > Anzahl Sockel

**Bestellhinweis**

- Zur Stabilisierung sind erforderlich
- > ab Länge 800 mm: 3 Sockel
  - > ab Länge 1.400 mm: 4 Sockel
  - > bei Länge 2.000 mm: 5 Sockel

Gewindeschrauben M4

► MB 1.470

DGH-M 2018, HIDE-de, 06/18; Maßangaben unverbindlich. Konstruktionsänderungen vorbehalten.

1  
CAD  
Möbelgriffe zeitlos

1

Möbelgriffe zeitlos

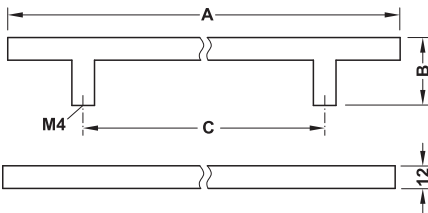
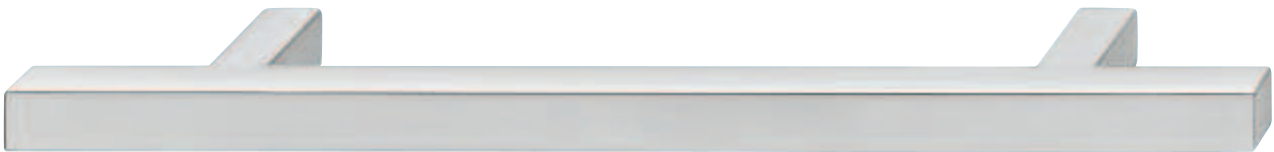
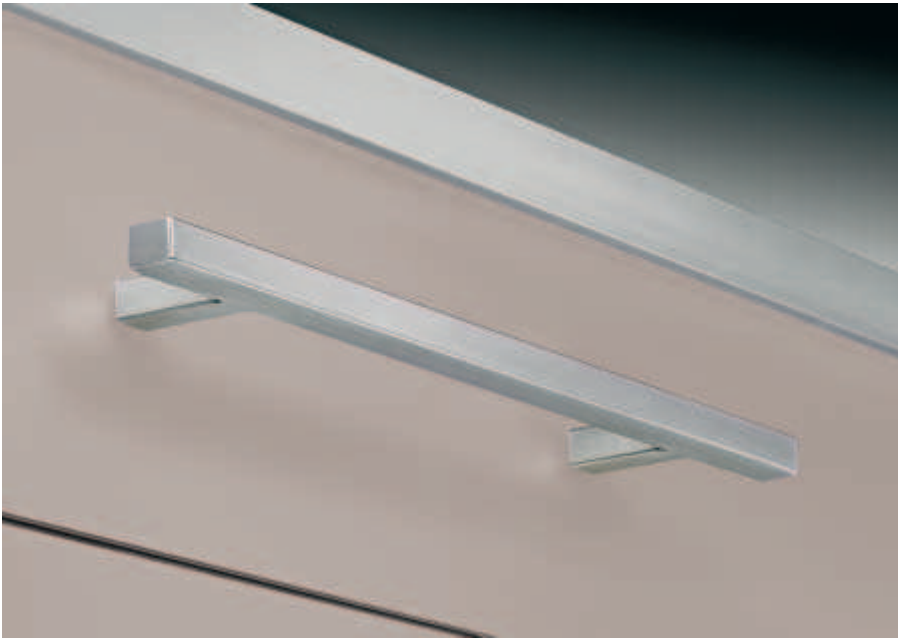

> Werkstoff: Edelstahl, Güte 1.4301/AISI 304  
> Oberfläche: matt gebürstet

Maß A mm	Maß B mm	Maß C mm	Abpackung Stück	Artikel-Nr.
240	36	160	1 oder 10	155.01.190
304	36	224	1 oder 8	155.01.191
400	36	320	1 oder 6	155.01.192

Gewindeschrauben M4

► MB 1.470

DGH-M 2018; HDE-de, 06/18; Maßangaben unverbindlich. Konstruktionsänderungen vorbehalten.



Möbelgriff – Topco

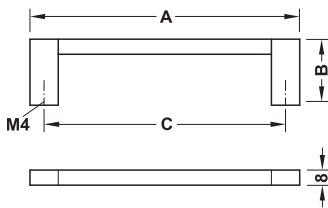

**topCo** KUNDENINDIVIDUELL  
BEREITS AB EINEM STÜCK

Diese Griffe sind auch mit einer Logo-Beschriftung am Sockel erhältlich.

> Oberfläche: matt gebürstet

Maß A mm	Maß B mm	Maß C mm	Artikel-Nr.
111	35	96	115.76.031
143	35	128	115.76.032
175	35	160	115.76.033
207	35	192	115.76.034

Abpackung: 1 oder 10 Stück

Laser-Beschriftung ▶ MB 1.206

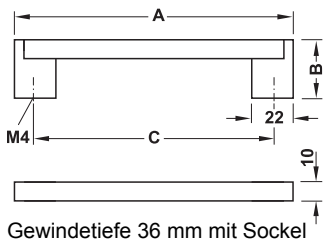

> Werkstoff: Griff: Edelstahl, Güte 1.4301/AISI 304, Sockel: Stahl  
> Oberfläche/ Farbe: Griff: matt, Sockel: edelstahlfarben matt

Maß A mm	Maß B mm	Maß C mm	Abpackung Stück	Artikel-Nr.
116	38	96	1, 10 oder 100	155.00.960
148	38	128	1, 10 oder 100	155.00.961
212	38	192	1, 10 oder 60	155.00.962
244	38	224	1, 10 oder 60	155.00.963
340	38	320	1, 10 oder 50	155.00.964
500	38	480	1, 10 oder 40	155.00.965
692	38	672	1, 10 oder 30	155.00.966

Gewindeschraube M4 ▶ MB 1.470

DGH-M 2018, HDE-de, 06/18; Maßangaben unverbindlich. Konstruktionsänderungen vorbehalten.

1



Möbelgriffe zeitlos

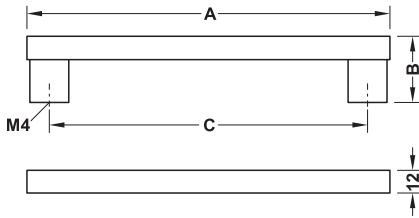

- > Werkstoff: Edelstahl, Güte 1.4301/AISI 304
- > Ausführung: Griff: Edelstahlrohr, Sockel: Zinkdruckguss
- > Oberfläche/Farbe: Griff: matt gebürstet, Sockel: edelstahlfarben matt gebürstet

Maß A mm	Maß B mm	Maß C mm	Abpackung Stück	Artikel-Nr.
150	35	128	1 oder 15	155.01.470
182	35	160	1 oder 15	155.01.471
214	35	192	1 oder 15	155.01.472
310	35	288	1 oder 15	155.01.473
342	35	320	1 oder 10	155.01.474
514	35	492	1 oder 5	155.01.475
814	35	792	1 oder 5	155.01.476

### Möbelgriff – Topco

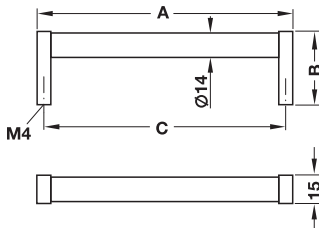

- > Werkstoff: Edelstahl, Güte 1.4305/AISI 303
- > Oberfläche: matt gebürstet

Maß A mm	Maß B mm	Maß C mm	Artikel-Nr.
104	42	96	115.76.601
136	42	128	115.76.602
168	42	160	115.76.603
200	42	192	115.76.604

Abpackung: 1 oder 10 Stück

**topCo** KUNDENINDIVIDUELL  
BEREITS AB EINEM STÜCK

Diese Griffe sind auch mit einer Logo-Beschriftung am Sockel erhältlich.

Laser-Beschriftung ► MB 1.206

Gewindeschrauben M4 ► MB 1.470

DGH-M 2018; HDE-de, 06/18; Maßangaben unverbindlich. Konstruktionsänderungen vorbehalten.

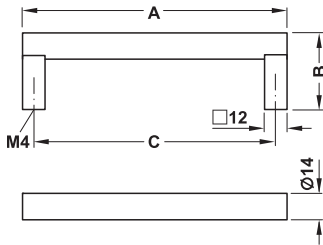

Schraubenlänge = 31 mm + Holzdicke

- > Werkstoff: Edelstahl, Güte 1.4305/AISI 303
- > Oberfläche: matt gebürstet
- > Ausführung: Sockel lose

Maß A mm	Maß B mm	Maß C mm	Artikel-Nr.
108	40	96	100.44.001
140	40	128	100.44.002
172	40	160	100.44.003
204	40	192	100.44.004
236	40	224	100.44.005
300	40	288	100.44.006
332	40	320	100.44.007
364	40	352	100.44.008
460	40	448	100.44.009

Abpackung: 1 Stück

### Möbelgriff – Topco

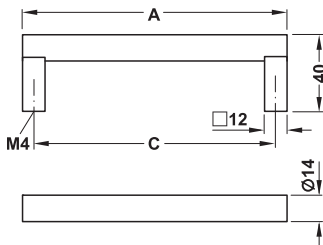

Schraubenlänge = 31 mm + Holzdicke

- > Werkstoff: Edelstahl, Güte 1.4305
- > Oberfläche: matt gebürstet
- > Ausführung: Sockel lose

Länge mm	Artikel-Nr.
Fixlänge (bis 2.400 mm)	100.44.019

Abpackung: 1 Stück

**topCo** KUNDENINDIVIDUELL  
BEREITS AB EINEM STÜCK

Folgende Eigenschaften können Sie wählen:

- > Grifflänge (Maß A)
- > Lochabstand (Maß C, ggf. C1)
- > Anzahl Sockel

#### Bestellhinweis

- Zur Stabilisierung sind erforderlich
- > ab Länge 1.000 mm: 3 Sockel
  - > ab Länge 1.600 mm: 4 Sockel

Gewindeschrauben M4

► MB 1.470

1



Lieferbar auch für gängige Standardkorpusbreiten



Möbelgriffe zeitlos

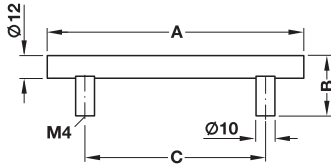

> Werkstoff: Aluminium  
> Oberfläche: silberfarben eloxiert

Korpusbreite mm	Maß A mm	Maß B mm	Maß C mm	Artikel-Nr.
–	136	32	96	109.54.931
–	168	32	128	109.54.932
300	200	32	160	109.54.933
–	232	32	192	109.54.934
350	250	32	210	109.54.935
400	300	32	260	109.54.936
450	350	32	310	109.54.938
500	400	32	360	109.54.940
550	450	32	410	109.54.941
600	500	32	460	109.54.943
700	600	32	560	109.54.944
800	700	32	660	109.54.945
900	800	32	760	109.54.946
1000	900	32	860	109.54.947

Abpackung: 1 oder 25 Stück

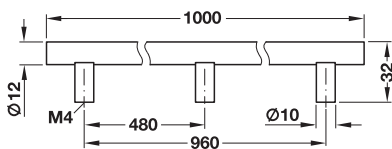

> Werkstoff: Aluminium  
> Ausführung: mit 3 Sockeln

Oberfläche	Artikel-Nr.
silberfarben eloxiert	109.54.948

Abpackung: 1 oder 25 Stück

Gewindeschrauben M4

► MB 1.470

DGH-M 2018; HDE-de, 06/18; Maßangaben unverbindlich. Konstruktionsänderungen vorbehalten.



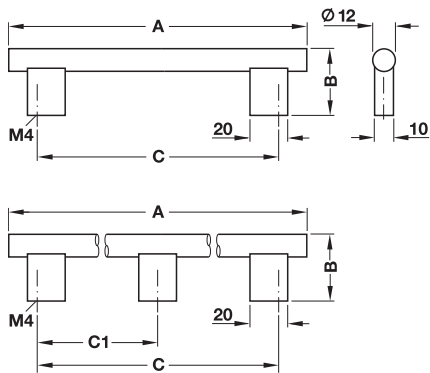

> Ausführung: mit fest montierter Gewindehülse, Sockel lose, Sockelbohrung außerhalb der Mitte, dadurch 2 Möbelgriffvarianten möglich

Oberfläche/ Farbe	Korpusbreite mm	Maß A mm	Maß B mm	Maß C mm	Maß C1 mm	Artikel-Nr.
<b>mit 2 Sockeln</b>						
silberfarben eloxiert	–	126	35	96	–	155.00.980
	–	158	35	128	–	155.00.981
	300	190	35	160	–	155.00.982
	–	222	35	192	–	155.00.983
	350	240	35	210	–	155.00.984
	400	290	35	260	–	155.00.985
	–	318	35	288	–	155.00.986
	450	340	35	310	–	155.00.987
	–	382	35	352	–	155.00.988
	500	390	35	360	–	155.00.989
	550	440	35	410	–	155.00.990
	–	478	35	448	–	155.00.991
600	490	35	460	–	155.00.992	
700	590	35	560	–	155.00.993	
800	690	35	660	–	155.00.994	
schwarz eloxiert	–	158	35	128	–	109.32.890
	300	190	35	160	–	109.32.891
	–	222	35	192	–	109.32.892
<b>mit 3 Sockeln</b>						
silberfarben eloxiert	900	790	35	760	380	155.00.995
	1000	890	35	860	430	155.00.996
	–	990	35	960	480	155.00.997

Abpackung: 1 oder 25 Stück

DGH-M 2018, HIDE-de, 06/18; Maßangaben unverbindlich. Konstruktionsänderungen vorbehalten.

Gewindeschrauben M4

► MB 1.470

17.07.2019  
ID 4406

Möbelgriff – Topco

1

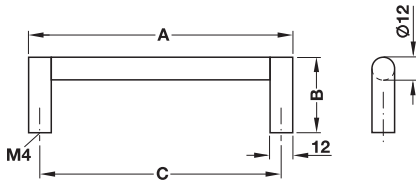

> Oberfläche: silberfarben eloxiert

Maß A mm	Maß B mm	Maß C mm	Artikel-Nr.
140	40	128	107.55.903
172	40	160	107.55.904
204	40	192	107.55.905
332	40	320	107.55.908

Abpackung: 1 oder 10 Stück

Möbelgriffe zeitlos

**topCo** KUNDENINDIVIDUELL  
BEREITS AB EINEM STÜCK

Diese Griffe sind auch mit einer Logo-Beschriftung am Sockel erhältlich.

Laser-Beschriftung – Topco



	Artikel-Nr.
Logo	100.86.999
Beschriftung pro Logo	100.86.998

**Bestellhinweis**

Logo-Vorlage und Logo-Position inkl. Skizze bitte der Bestellung beifügen.

Pro Auftrag entstehen Rüstkosten, Artikel-Nr. 100.86.997.

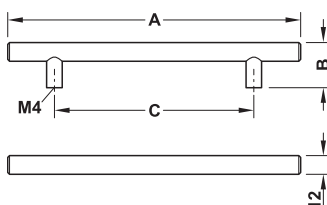

> Werkstoff: Aluminium  
> Oberfläche: silberfarben eloxiert

Maß A mm	Maß B mm	Maß C mm	Artikel-Nr.
284	30	224	107.62.905
344	30	284	107.62.906
444	30	384	107.62.908
544	30	484	107.62.911
655	30	595	107.62.913

Abpackung: 1 Stück

Gewindeschrauben M4 ▶ MB 1.470

DGH-M 2018; HDE-de, 06/18; Maßangaben unverbindlich. Konstruktionsänderungen vorbehalten.

Modell H1555

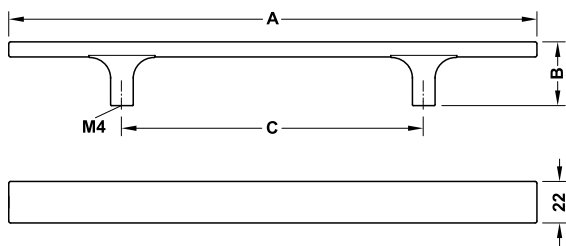
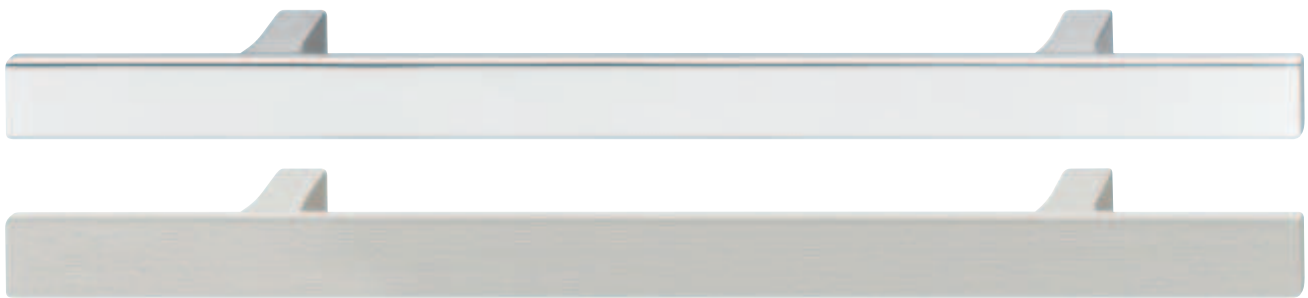

> Werkstoff: Griff: Aluminium,  
Sockel: Zinkdruckguss

Oberfläche/ Farbe	Maß A	Maß B mm	Maß C mm	Abpackung Stück	Artikel-Nr.
verchromt poliert	312	34	192	1 oder 25	106.60.205
	440	34	320	1 oder 10	106.60.208
	568	34	448	1 oder 10	106.60.209
edelstahl- farben	312	34	192	1 oder 25	106.60.005
	440	34	320	1 oder 10	106.60.008
	568	34	448	1 oder 10	106.60.009

Gewindeschrauben M4

► MB 1.470

DGH-M 2018, HIDE-de, 06/18; Maßangaben unverbindlich. Konstruktionsänderungen vorbehalten.

1  
CAD  
Möbelgriffe zeitlos

1



Möbelgriffe zeitlos

Modell H1560

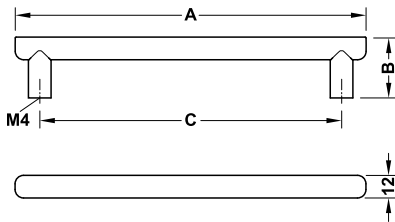

Oberfläche/ Farbe	Maß A mm	Maß B mm	Maß C mm	Ab- packung Stück	Artikel-Nr.
verchromt poliert	186	31	160	1 oder 25	106.60.214
	218	31	192	1 oder 25	106.60.216
	346	31	320	1 oder 10	106.60.218
edelstahl- farben	186	31	160	1 oder 25	106.60.014
	218	31	192	1 oder 25	106.60.016
	346	31	320	1 oder 10	106.60.018
champagner- farben	186	31	160	1 oder 25	106.60.614
	218	31	192	1 oder 25	106.60.616
	346	31	320	1 oder 10	106.60.618

Gewindeschrauben M4

► MB 1.470

DGH-M 2018; HDE-de, 06/18; Maßangaben unverbindlich. Konstruktionsänderungen vorbehalten.

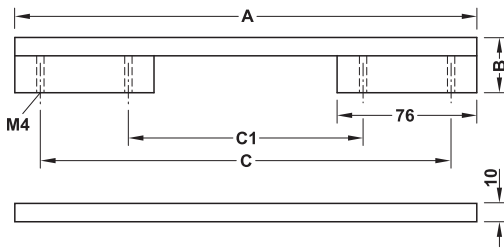
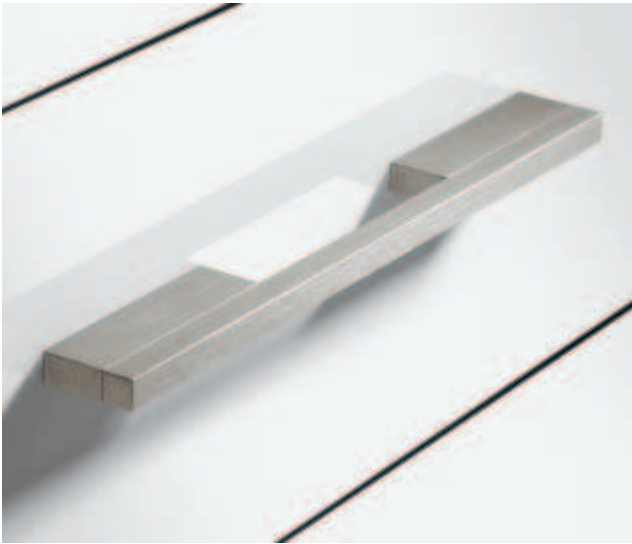

Oberfläche	Maß A mm	Maß B mm	Maß C1 mm	Maß C mm	Artikel-Nr.
silberfarben eloxiert	252	30	128	224	108.95.920
	284	30	160	256	108.95.921
	316	30	192	288	108.95.922
	348	30	224	320	108.95.923
	412	30	288	384	108.95.924
	476	30	352	448	108.95.925
	604	30	480	576	108.95.926
edelstahl- farben	252	30	128	224	108.95.020
	284	30	160	256	108.95.021
	316	30	192	288	108.95.022
	348	30	224	320	108.95.023
	412	30	288	384	108.95.024
	476	30	352	448	108.95.025
	604	30	480	576	108.95.026

Abpackung: 1 oder 25 Stück

DGH-M 2018, HIDE-de, 06/18; Maßangaben unverbindlich. Konstruktionsänderungen vorbehalten.

Gewindeschrauben M4

► MB 1.470

1

Möbelgriffe zeitlos

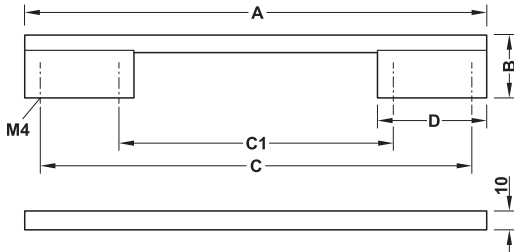

> Oberfläche/Farbe: silberfarben eloxiert

Maß A mm	Maß B mm	Maß C mm	Maß C1 mm	Maß D mm	Artikel-Nr.
156	29	128	96	44	155.00.970
220	29	192	128	60	155.00.971
284	29	256	160	76	155.00.972
348	29	320	192	92	155.00.973
412	29	384	224	108	155.00.974
476	29	448	256	124	155.00.975
540	29	512	288	140	155.00.976

Abpackung: 1 oder 20 Stück

Gewindeschrauben M4

► MB 1.470

DGH-M 2018; HDE-de, 06/18; Maßangaben unverbindlich. Konstruktionsänderungen vorbehalten.

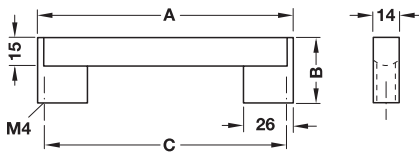

> Werkstoff: Griff: Aluminium,  
Sockel: Zinkdruckguss  
> Oberfläche: Griff: silberfarben eloxiert,  
Sockel: verchromt poliert

Maß A mm	Maß B mm	Maß C mm	Artikel-Nr.
138	35	128	100.88.941
170	35	160	100.88.942
202	35	192	100.88.943
234	35	224	100.88.944
298	35	288	100.88.945
330	35	320	100.88.946
362	35	352	100.88.947
490	35	480	100.88.948
650	35	640	100.88.949

Abpackung: 1 oder 10 Stück

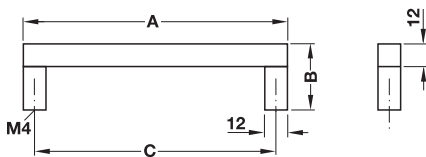

> Oberfläche/Farbe: silberfarben eloxiert

Maß A mm	Maß B mm	Maß C mm	Artikel-Nr.
140	35	128	155.01.030
172	35	160	155.01.031
204	35	192	155.01.032
236	35	224	155.01.033
300	35	288	155.01.034
364	35	352	155.01.035
460	35	448	155.01.036

Abpackung: 1, 25 oder 200 Stück

DGH-M 2018, HIDE-de, 06/18; Maßangaben unverbindlich. Konstruktionsänderungen vorbehalten.

Gewindeschrauben M4

► MB 1.470

17.07.2019  
ID 4406



1



Möbelgriffe zeitlos

Griffrohr zum Ablängen

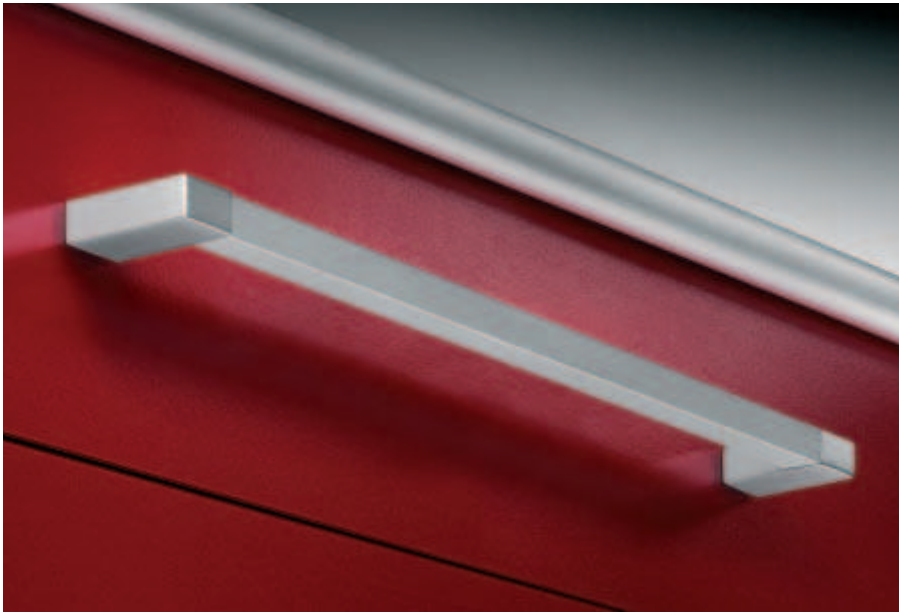

→ Rohr 14 x 16 mm, zum Ablängen

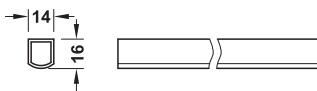

- > Werkstoff: Aluminium
- > Oberfläche: verchromt matt

Länge mm	Artikel-Nr.
500	111.41.900
1000	111.41.901

Abpackung: 1 Stück

→ Endstück

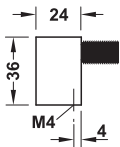

- > Werkstoff: Zinkdruckguss
- > Ausführung: mit Kunststoffhülse

Oberfläche	Artikel-Nr.
verchromt matt	111.41.410

Abpackung: 1 oder 50 Stück

Gewindeschrauben M4 ▶ MB 1.470

→ Mittelstück

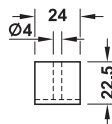

- > Werkstoff: Zinkdruckguss
- > Befestigungsmaterial im Lieferumfang enthalten

Oberfläche	Artikel-Nr.
verchromt matt	111.41.420

Abpackung: 1 oder 50 Stück

**Hinweis**

Bei Grifflänge 1.000 mm wird zur Stabilisierung ein Mittelstück empfohlen. Dafür ist eine Gewindebohrung im Aluminiumrohr erforderlich. Dieser Griff ist auch mit einem Adaptersockel für Faltschiebetüren erhältlich.

Griff für Faltschiebetüren ▶ MB 1.316

DGH-M 2018; HDE-de, 06/18; Maßangaben unverbindlich. Konstruktionsänderungen vorbehalten.



Anwendungsbeispiel

→ Rohrdurchmesser 16 mm, zum Ablängen

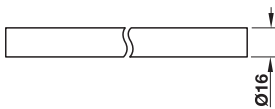

> Werkstoff: Messing

Oberfläche	Länge mm	Artikel-Nr.
verchromt matt	1000	111.02.431

Abpackung: 1 Stück

→ Endstück

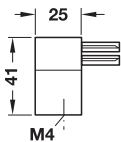

> Werkstoff: Zinkdruckguss

Oberfläche	Artikel-Nr.
verchromt matt	111.02.410

Abpackung: 1 oder 20 Stück

Griffrohre zum Ablängen



Anwendungsbeispiel

→ Rohr 15 x 15 mm, zum Ablängen

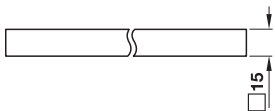

> Werkstoff: Messing

Oberfläche	Länge mm	Artikel-Nr.
verchromt matt	1000	111.01.431

Abpackung: 1 Stück

→ Endstück

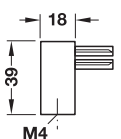

> Werkstoff: Zinkdruckguss

Oberfläche	Artikel-Nr.
verchromt matt	111.01.410

Abpackung: 1 oder 20 Stück

Gewindeschrauben M4

► MB 1.470

DGH-M 2018, HDE-de, 06/18; Maßangaben unverbindlich. Konstruktionsänderungen vorbehalten.

1

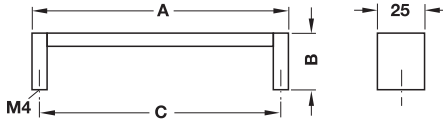

- > Werkstoff: Griff: Messing, Sockel: Zinkdruckguss
- > Oberfläche: Griff und Sockel: verchromt matt

Korpusbreite mm	Maß A mm	Maß B mm	Maß C mm	Ab- packung Stück	Artikel-Nr.
–	200	30	192	1 oder 25	100.99.444
400	334	30	326	1 oder 10	100.99.446
600	534	30	526	1 oder 10	100.99.449

Möbelgriffe zeitlos

Gewindeschrauben M4

► MB 1.470

DGH-M 2018; HDE-de, 06/18; Maßangaben unverbindlich. Konstruktionsänderungen vorbehalten.

Modell H1335

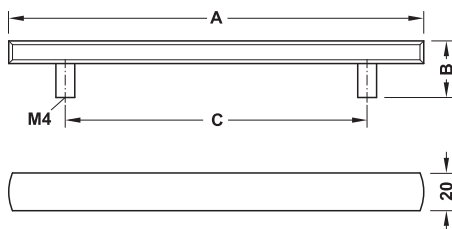

Oberfläche/Farbe	Maß A mm	Maß B mm	Maß C mm	Artikel-Nr.
verchromt poliert	219	32	160	110.35.276
	379	32	320	110.35.279
vernickelt gebürstet	219	32	160	110.35.676
	379	32	320	110.35.679
weiß, RAL 9016, matt, lackiert	219	32	160	110.35.776
	379	32	320	110.35.779
schwarz, RAL 9017, matt, lackiert	219	32	160	110.35.376
	379	32	320	110.35.379

Abpackung: 1 oder 10 Stück

Gewindeschrauben M4

► MB 1.470

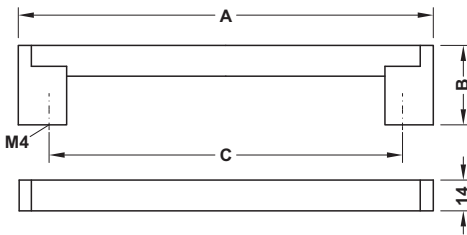

> Werkstoff: Griff: Stahl, Güte 1.4372/AISI 201,  
Sockel: Zinkdruckguss  
> Oberfläche: matt gebürstet

Maß A mm	Maß B mm	Maß C mm	Abpackung Stück	Artikel-Nr.
<b>Griff: Stahlrohr</b>				
156	36	128	1 oder 10	155.01.160
188	36	160	1 oder 10	155.01.161
220	36	192	1 oder 10	155.01.162
237	36	209	1 oder 10	155.01.163
284	36	256	1 oder 10	155.01.164
337	36	309	1 oder 10	155.01.165
348	36	320	1 oder 10	155.01.166
387	36	359	1 oder 10	155.01.167
437	36	409	1 oder 10	155.01.168
476	36	448	1 oder 10	155.01.169
537	36	509	1 oder 10	155.01.170
<b>Griff: Vollmaterial Stahl</b>				
751	36	709	1 oder 5	155.01.180
849	36	807	1 oder 5	155.01.181
951	36	909	1 oder 5	155.01.182
1199	36	1157	1 oder 5	155.01.183

Gewindeschrauben M4

► MB 1.470

DGH-M 2018; HDE-de, 06/18; Maßangaben unverbindlich. Konstruktionsänderungen vorbehalten.

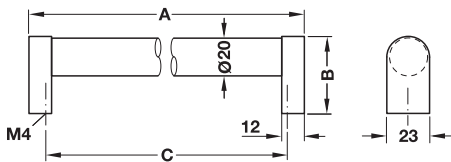

- > Werkstoff: Griff: Stahl, Sockel: Zinkdruckguss
- > Oberfläche: Griff und Sockel: edelstahlfarben

Maß A mm	Maß B mm	Maß C mm	Artikel-Nr.
176	43	160	108.65.002
240	43	224	108.65.004

Abpackung: 1 oder 50 Stück

DGH-M 2018, HIDE-de, 06/18; Maßangaben unverbindlich. Konstruktionsänderungen vorbehalten.

Gewindeschrauben M4

► MB 1.470

1



Möbelgriffe zeitlos



Bei diesen Griffen wurden bewusst Gebrauchsspuren eingearbeitet. Dadurch ist jeder Griff ein Unikat.

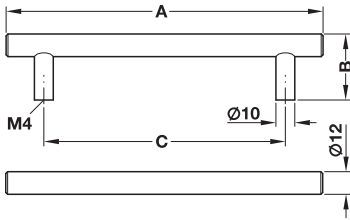

> Oberfläche/Farbe: grau, Used Look

Maß A mm	Maß B mm	Maß C mm	Artikel-Nr.
168	35	128	115.71.132
232	35	192	115.71.134

Abpackung: 1 oder 10 Stück

Gewindeschrauben M4

► MB 1.470

DGH-M 2018; HDE-de, 06/18; Maßangaben unverbindlich. Konstruktionsänderungen vorbehalten.



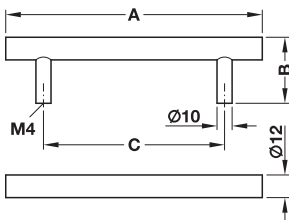

Oberfläche/Farbe	Maß A mm	Maß B mm	Maß C mm	Abpackung Stück	Artikel-Nr.
verchromt poliert	136	35	96	1 oder 20	155.00.360
	168	35	128	1 oder 20	155.00.361
	200	35	160	1 oder 20	155.00.362
	226	35	156	1 oder 20	155.00.810
	232	35	192	1 oder 20	155.00.363
	264	35	224	1 oder 20	155.00.364
	328	35	288	1 oder 10	155.00.365
	376	35	306	1 oder 10	155.00.811
	392	35	352	1 oder 10	155.00.366
	488	35	448	1 oder 10	155.00.812
	526	35	456	1 oder 10	155.00.813
	600	35	560	1 oder 10	155.00.814
	700	35	660	1 oder 5	155.00.815
828	35	758	1 oder 5	155.00.816	
verchromt matt	136	35	96	1 oder 10	155.00.690
	168	35	128	1 oder 10	155.00.691
	200	35	160	1 oder 10	155.00.692
	226	35	156	1 oder 10	155.00.730
	232	35	192	1 oder 10	155.00.693
	264	35	224	1 oder 10	155.00.740
	328	35	288	1 oder 10	155.00.694
	376	35	306	1 oder 10	155.00.731
	392	35	352	1 oder 10	155.00.695
	488	35	448	1 oder 10	155.00.732
	526	35	456	1 oder 10	155.00.734
	600	35	560	1 oder 10	155.00.735
	700	35	660	1 oder 10	155.00.736
828	35	758	1 oder 10	155.00.737	

Gewindeschrauben M4

► MB 1.470

DGH-M 2018, HDE-de, 06/18; Maßangaben unverbindlich. Konstruktionsänderungen vorbehalten.

Möbelgriffe zeitlos

1

Möbelgriffe zeitlos

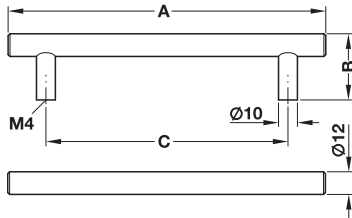

Maß A mm	Maß B mm	Maß C mm	vernickelt matt	edelstahl- farben	oil rubbed bronze, Used Look	schwarz, matt
136	35	96	155.00.700	155.00.780	155.00.760	155.01.660
168	35	128	155.00.701	155.00.781	155.00.761	155.01.661
200	35	160	155.00.702	155.00.782	–	155.01.662
226	35	156	155.00.703	155.00.783	155.00.762	–
232	35	192	155.00.704	155.00.784	–	155.01.663
250	35	210	–	155.00.785	–	–
264	35	224	155.00.705	155.00.720	–	–
300	35	260	–	155.00.786	–	–
326	35	256	–	155.00.787	–	–
328	35	288	155.00.706	155.00.788	–	155.01.664
376	35	306	155.00.707	155.00.789	155.00.763	–
392	35	352	155.00.708	155.00.790	–	155.01.665
400	35	360	–	155.00.791	–	–
424	35	384	–	–	–	155.01.666
426	35	356	–	155.00.792	–	–
488	35	448	155.00.770	155.00.793	–	155.01.667
500	35	460	–	155.00.794	–	–
526	35	456	155.00.709	155.00.795	155.00.750	–
600	35	560	155.00.771	155.00.796	–	–
700	35	660	155.00.772	155.00.797	–	–
702	35	632	–	155.00.798	–	–
800	35	760	–	155.00.799	–	–
828	35	758	155.00.710	155.00.800	–	–

Abpackung: 1 oder 10 Stück

Gewindeschrauben M4

► MB 1.470

DGH-M 2018; HDE-de, 06/18; Maßangaben unverbindlich. Konstruktionsänderungen vorbehalten.

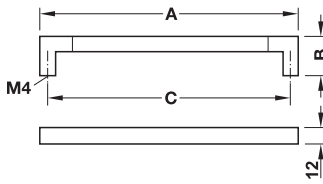

- > Werkstoff: Griff: Eiche, Sockel: Zinkdruckguss
- > Oberfläche: Griff: lackiert, Sockel: verchromt matt
- > Ausführung: Sockel montiert

Werkstoff	Maß A mm	Maß B mm	Maß C mm	Artikel-Nr.
Griff: Eiche	140	35	128	194.60.442
Sockel:	204	35	192	194.60.444
Zinkdruckguss	236	35	224	194.60.445

Abpackung: 1 oder 10 Stück

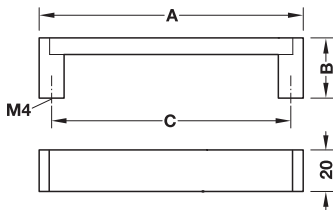

- > Werkstoff: Griff: Holz, Sockel: Zinkdruckguss
- > Oberfläche: Griff: natur, Sockel: verchromt matt
- > Ausführung: Sockel lose

Maß A mm	Maß B mm	Maß C mm	Artikel-Nr.
<b>Griffstück in Nussbaum</b>			
108	29	96	103.94.741
140	29	128	103.94.742
204	29	192	103.94.744
<b>Griffstück in Eiche</b>			
140	29	128	103.94.442
204	29	192	103.94.444

Abpackung: 1 oder 10 Stück

DGH-M 2018, HIDE-de, 06/18; Maßangaben unverbindlich. Konstruktionsänderungen vorbehalten.

Gewindeschrauben M4

► MB 1.470

1



Möbelgriffe zeitlos



Das Griffteil von 194.01.304 ist aus Buche und mit einem schwarzen Softlack überzogen. Die Oberfläche fühlt sich wie Leder oder Gummi an.

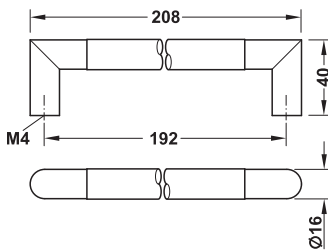

> Oberfläche: Griff: lackiert, Sockel: edelstahlfarben

Werkstoff	Artikel-Nr.
Griff: Nussbaum Sockel: Zinkdruckguss	194.01.704
Griff: schwarz Sockel: Zinkdruckguss	194.01.304
Griff: Eiche Sockel: Zinkdruckguss	194.01.404

Abpackung: 1 oder 25 Stück

Gewindeschrauben M4

► MB 1.470

DGH-M 2018; HDE-de, 06/18; Maßangaben unverbindlich. Konstruktionsänderungen vorbehalten.

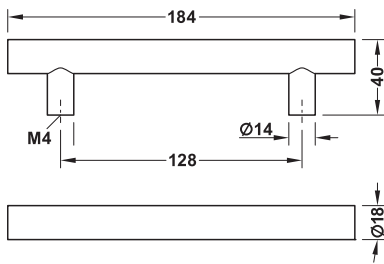

> Werkstoff: Griff: Glas  
Sockel: Edelstahl, Güte 1.4305

Oberfläche	Artikel-Nr.
Griff: matt	109.46.515
Griff: klar	109.46.415

Abpackung: 1 Stück

passender Möbelknopf	► MB 1.286
Gewindeschrauben M4	► MB 1.470

1

Möbelgriffe zeitlos

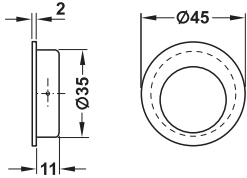

> Werkstoff: Edelstahl, Güte 1.4301

Oberfläche	Artikel-Nr.
außen: matt gebürstet innen: schwarz	152.57.020

Abpackung: 1 oder 25 Stück

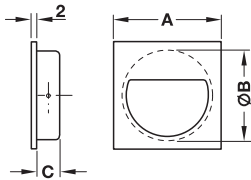

> Werkstoff: Edelstahl, Güte 1.4301  
> Oberfläche: außen: matt gebürstet,  
innen: schwarz

Maß A mm	Maß B mm	Maß C mm	Artikel-Nr.
47	38	11	152.57.000

Abpackung: 1 oder 25 Stück

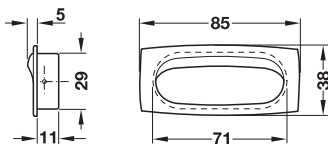

> Werkstoff: Edelstahl, Güte 1.4301

Oberfläche	Artikel-Nr.
außen: matt gebürstet innen: schwarz	152.57.010

Abpackung: 1 oder 25 Stück

Rundkopf-Metallstifte Ø 0,9 mm

► MB 1.471

DGH-M 2018; HDE-de, 06/18; Maßangaben unverbindlich. Konstruktionsänderungen vorbehalten.

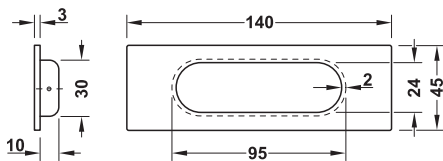

- > Werkstoff: Edelstahl, Güte 1.4301/AISI 304
- > Befestigungsmaterial im Lieferumfang enthalten

Oberfläche	Artikel-Nr.
matt gebürstet	155.01.495
vermessingt poliert, PVD-beschichtet	151.38.120
graphitschwarz, PVD-beschichtet	151.38.121

Abpackung: 1 oder 15 Stück

DGH-M 2018, HIDE-de, 06/18; Maßangaben unverbindlich. Konstruktionsänderungen vorbehalten.

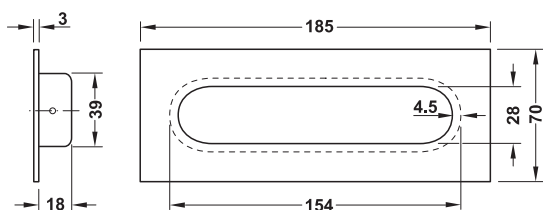

- > Werkstoff: Edelstahl, Güte 1.4301/AISI 304
- > Befestigungsmaterial im Lieferumfang enthalten

Oberfläche	Artikel-Nr.
matt gebürstet	155.01.496

Abpackung: 1 oder 6 Stück



1



- > Werkstoff: Edelstahl, Güte 1.4301/AISI 304
- > Befestigungsmaterial im Lieferumfang enthalten

Oberfläche	Artikel-Nr.
matt gebürstet	155.01.506

Abpackung: 1 oder 20 Stück

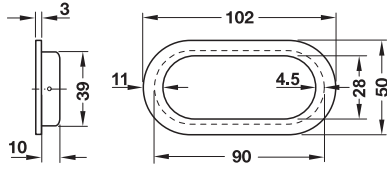

Möbelgriffe zeitlos



- > Werkstoff: Edelstahl, Güte 1.4301/AISI 304
- > Befestigungsmaterial im Lieferumfang enthalten

Oberfläche	Artikel-Nr.
matt gebürstet	155.01.505
vermessingt poliert, PVD-beschichtet	151.38.110
graphitschwarz, PVD-beschichtet	151.38.111

Abpackung: 1 oder 15 Stück

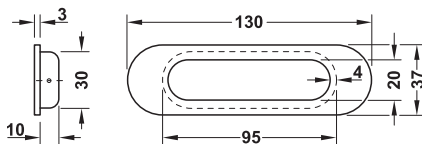

- > Werkstoff: Edelstahl, Güte 1.4301/AISI 304
- > Befestigungsmaterial im Lieferumfang enthalten

Oberfläche	Artikel-Nr.
matt gebürstet	155.01.507

Abpackung: 1 oder 6 Stück

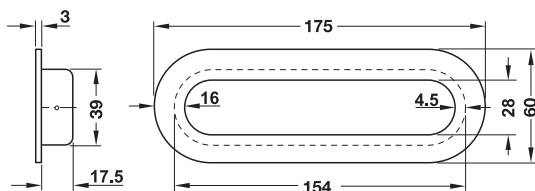

DGH-M 2018; HDE-de, 06/18; Maßangaben unverbindlich. Konstruktionsänderungen vorbehalten.



> Werkstoff: Edelstahl, Güte 1.4301/AISI 304  
> Oberfläche: matt gebürstet

Oberfläche	Artikel-Nr.
matt gebürstet	155.01.605

Abpackung: 1 oder 32 Stück

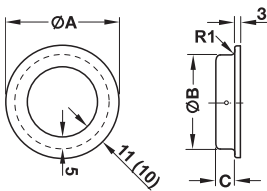
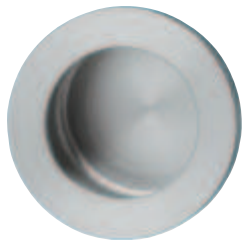
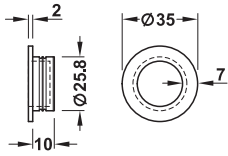

> Werkstoff: Edelstahl, Güte 1.4301/AISI 304  
> Befestigungsmaterial im Lieferumfang enthalten

Oberfläche/Farbe	Maß A mm	Maß B mm	Maß C mm	Abpackung Stück	Artikel-Nr.
matt gebürstet	50	40	12	1 oder 30	155.01.490
	60	50	12	1 oder 10	155.01.491
	80	62	14	1 oder 12	155.01.492
vermessingt poliert, PVD-beschichtet	50	40	12	1 oder 30	151.38.100
	60	50	12	1 oder 20	151.38.101
graphitschwarz, PVD-beschichtet	50	40	12	1 oder 30	151.38.102
	60	50	12	1 oder 20	151.38.103

DGH-M 2018, HIDE-de, 06/18; Maßangaben unverbindlich. Konstruktionsänderungen vorbehalten.

Möbelgriffe zeitlos

1



Möbelgriffe zeitlos

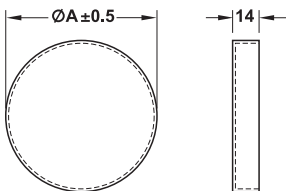

- > Werkstoff: Edelstahl, Güte 1.4301
- > Oberfläche: matt gebürstet
- > Montage: schraubenlose Befestigung, zum Kleben
- > Einsatzbereich: für Schiebetüren

Maß A mm	Artikel-Nr.
60,3	151.38.020

Abpackung: 1 oder 10 Stück

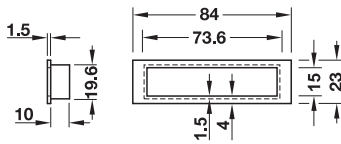
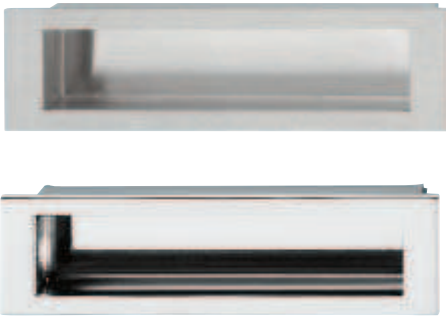

> Werkstoff: Edelstahl, Güte 1.4301  
> Montage: schraubenlose Befestigung zum Kleben

Oberfläche	Artikel-Nr.
matt gebürstet	152.52.000
poliert	152.52.060

Abpackung: 1 oder 10 Stück

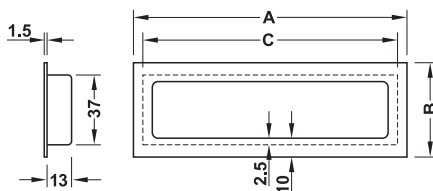

> Werkstoff: Edelstahl, Güte 1.4301/AISI 304  
> Montage: schraubenlose Befestigung, zum Kleben

Oberfläche/Farbe	Maß A mm	Maß B mm	Maß C mm	Artikel-Nr.
matt gebürstet	100	50	90	152.52.010
	145	50	135	152.52.011
	210	50	200	152.52.012
schwarz matt, RAL 9017	100	50	90	152.52.310
	145	50	135	152.52.342
	210	50	200	152.52.312

Abpackung: 1 oder 10 Stück

1



Möbelgriffe zeitlos



> Werkstoff: Edelstahl, Güte 1.4301/AISI 304  
> Montage: schraubenlose Befestigung, zum Kleben

Oberfläche/ Farbe	Maß A mm	Maß B mm	Maß C mm	Artikel-Nr.
matt gebürstet	50	40	13	152.52.040
schwarz matt, RAL 9017	75	60	13	152.52.341

Abpackung: 1 oder 10 Stück

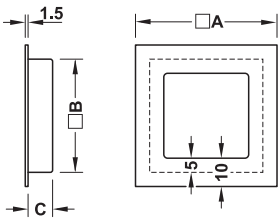

> Werkstoff: Edelstahl, Güte 1.4301/AISI 304  
> Oberfläche: matt gebürstet  
> Befestigungsmaterial im Lieferumfang enthalten

Maß A mm	Maß B mm	Maß C mm	Artikel-Nr.
59	40	12	155.01.500
69	50	12	155.01.501

Abpackung: 1 oder 12 Stück

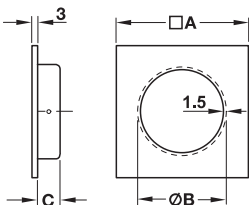

DGH-M 2018; HDE-de, 06/18; Maßangaben unverbindlich. Konstruktionsänderungen vorbehalten.



Diese Muschelgriffe sind zum Einkleben in Glasschiebetüren geeignet.

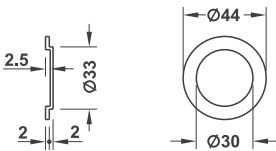

- > Werkstoff: Edelstahl, Güte 1.4305
- > Montage: schraubenlose Befestigung, zum Kleben
- > Einsatzbereich: zum Einlassen in Glasschiebetüren

Oberfläche	Artikel-Nr.
matt gebürstet	152.52.090

Abpackung: 1 oder 10 Stück

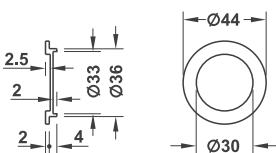

- > Werkstoff: Edelstahl, Güte 1.4305
- > Montage: schraubenlose Befestigung, zum Kleben
- > Einsatzbereich: zum Einlassen in Glasschiebetüren

Oberfläche	Artikel-Nr.
matt gebürstet	152.52.095

Abpackung: 1 oder 10 Stück

1

GAEB

CAD

Möbelgriffe zeitlos



Diese Muschelgriffe sind für Glastüren geeignet, auf die von beiden Seiten zugegriffen wird.

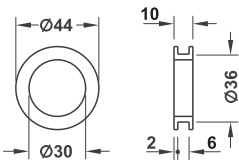
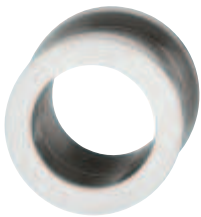

- > Werkstoff: Edelstahl, Güte 1.4305
- > Montage: schraubenlose Befestigung, zum Kleben
- > Einsatzbereich: für Durchgangsbohrungen Ø 37 mm in Glasschiebetüren

Oberfläche	Artikel-Nr.
matt gebürstet	152.52.086

Abpackung: 1 oder 10 Stück

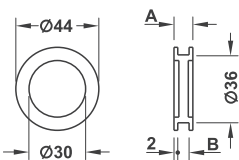
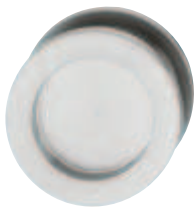

- > Werkstoff: Edelstahl, Güte 1.4305
- > Oberfläche: matt gebürstet
- > Montage: schraubenlose Befestigung, zum Kleben
- > Einsatzbereich: für Durchgangsbohrungen Ø 37 mm in Glasschiebetüren

Maß A mm	Maß B mm	Artikel-Nr.
8	4	152.53.082
12	8	152.53.086

Abpackung: 1 oder 10 Stück



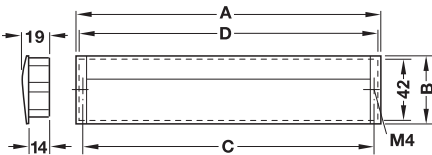
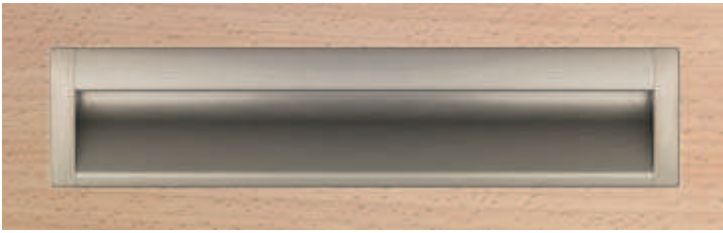

> Werkstoff: Muschelgriff: Aluminium,  
Endkappen: Zinkdruckguss

Oberfläche	Maß A mm	Maß B mm	Maß C mm	Maß D mm	Artikel-Nr.
silber- farben	143	49	128	137	151.86.921
	175	49	160	169	151.86.922
	207	49	192	201	151.86.923
	335	49	320	329	151.86.927
edelstahl- farben	143	49	128	137	151.86.021
	175	49	160	169	151.86.022
	207	49	192	201	151.86.023
	335	49	320	329	151.86.027

Abpackung: 1 oder 10 Stück

Gewindeschrauben M4

► MB 1.470

1



Möbelgriffe zeitlos

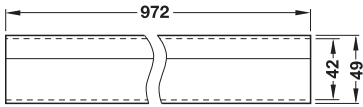

> Ausführung: zum Ablängen,  
ohne Endkappen

Oberfläche	Artikel-Nr.
silberfarben	151.86.930
edelstahlfarben	151.86.030

Abpackung: 1 oder 10 Stück

→ Endkappe

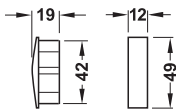
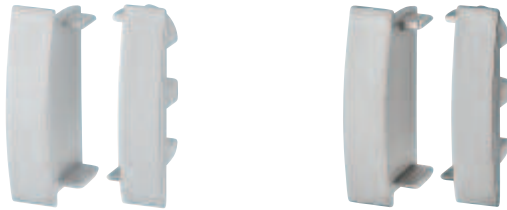

> Werkstoff: Zinkdruckguss  
> passend zu 151.86.930 und 151.86.030

Oberfläche	Artikel-Nr.
aluminiumfarben	151.86.989
edelstahlfarben	151.86.089

Abpackung: 1 oder 25 Paare

Gewindeschrauben M4

► MB 1.470

DGH-M 2018; HDE-de, 06/18; Maßangaben unverbindlich. Konstruktionsänderungen vorbehalten.

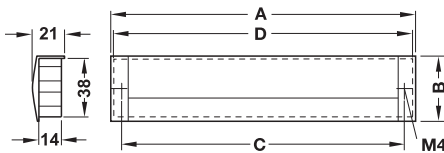

> Werkstoff: Muschelgriff: Aluminium,  
Endkappen: Zinkdruckguss

Oberfläche	Maß A mm	Maß B mm	Maß C mm	Maß D mm	Artikel-Nr.
silber- farben	143	43	128	137	151.85.921
	175	43	160	169	151.85.922
	207	43	192	201	151.85.923
edelstahl- farben	335	43	320	329	151.85.927
	143	43	128	137	151.85.021
	175	43	160	169	151.85.022
	207	43	192	201	151.85.023
	335	43	320	329	151.85.027

Abpackung: 1 oder 10 Stück

Gewindeschrauben M4

► MB 1.470

1



Möbelgriffe zeitlos

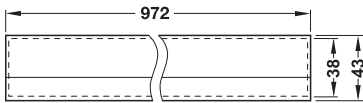

> Ausführung: zum Ablängen, ohne Endkappen

Oberfläche	Artikel-Nr.
silberfarben	151.85.930
edelstahlfarben	151.85.030

Abpackung: 1 oder 10 Stück

→ Endkappe

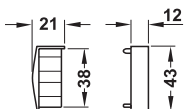

> Werkstoff: Zinkdruckguss  
> passend zu 151.85.930 und 151.85.030

Oberfläche	Artikel-Nr.
silberfarben	151.85.989
edelstahlfarben	151.85.089

Abpackung: 1 oder 25 Paare

Gewindeschrauben M4

► MB 1.470

DGH-M 2018; HDE-de, 06/18; Maßangaben unverbindlich. Konstruktionsänderungen vorbehalten.

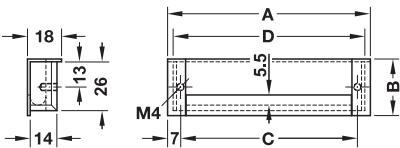

- > Werkstoff: Muschelgriff: Aluminium, Endkappen: Zinkdruckguss
- > Oberfläche: Muschelgriff und Endkappen: silberfarben

Maß A mm	Maß B mm	Maß C mm	Maß D mm	Artikel-Nr.
110	31	96	104	151.99.901
142	31	128	136	151.99.902
174	31	160	168	151.99.903

Abpackung: 1 oder 20 Stück

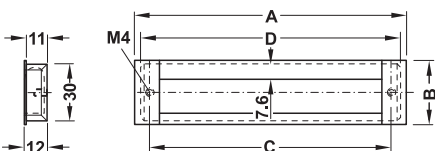
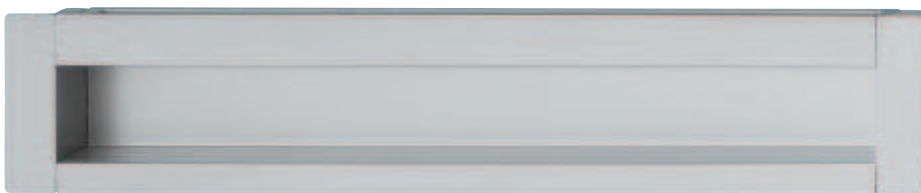

- > Werkstoff: Endstück: Zinkdruckguss, Mittelteil: Aluminium
- > Oberfläche/Farbe: aluminiumfarben

Maß A mm	Maß B mm	Maß C mm	Maß D mm	Artikel-Nr.
111	34	96	106	155.01.130
143	34	128	138	155.01.131
175	34	160	170	155.01.132
207	34	192	202	155.01.133

Abpackung: 1, 10 oder 100 Stück

Gewindeschrauben M4

► MB 1.470

DGH-M 2018, HIDE-de, 06/18; Maßangaben unverbindlich. Konstruktionsänderungen vorbehalten.

1



Möbelgriffe zeitlos

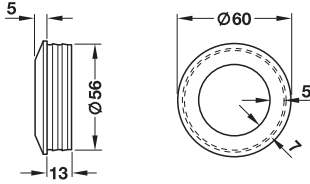

- > Werkstoff: Aluminium
- > Montage: schraubenlose Befestigung mit Leimrillen

Oberfläche	Artikel-Nr.
silberfarben eloxiert	103.74.704

Abpackung: 1 oder 25 Stück

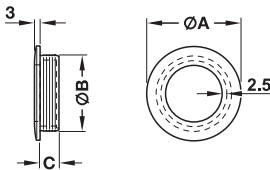

- > Werkstoff: Aluminium
- > Oberfläche: silberfarben eloxiert
- > Montage: schraubenlose Befestigung mit Leimrillen

Maß A mm	Maß B mm	Maß C mm	Artikel-Nr.
40	35	7	151.75.902
50	40	10	151.75.903

Abpackung: 1 oder 50 Stück

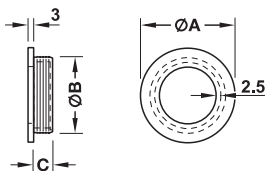

- > Werkstoff: Aluminium
- > Oberfläche: schwarz eloxiert
- > Montage: schraubenlose Befestigung mit Leimrillen

Maß A mm	Maß B mm	Maß C mm	Artikel-Nr.
50	40	10	151.38.900

Abpackung: 1 oder 10 Stück

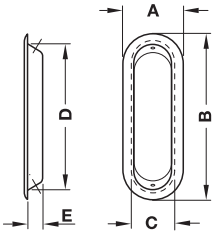

> Werkstoff: Stahl  
> Oberfläche: vernickelt, transparent matt pulverbeschichtet

Maß A mm	Maß B mm	Maß C mm	Maß D mm	Maß E mm	Artikel-Nr.
25	77	18	70	7	152.00.601
32	88	22	80	9	152.00.611

Abpackung: 1 oder 25 Stück

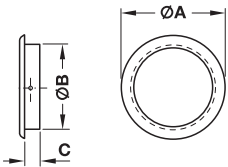

> Werkstoff: Stahl  
> Oberfläche: vernickelt, transparent matt pulverbeschichtet

Maß A mm	Maß B mm	Maß C mm	Artikel-Nr.
30	25	7	153.20.621
40	32	7	153.20.601
55	45	8	153.20.611

Abpackung: 1 oder 25 Stück

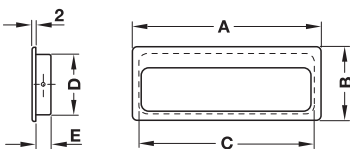

> Werkstoff: Stahl  
> Oberfläche: schwarz matt

Maß A mm	Maß B mm	Maß C mm	Maß D mm	Maß E mm	Artikel-Nr.
75	32	68	25	10	151.00.312
99	38	92	31	12	151.00.322

Abpackung: 1 oder 25 Stück

Rundkopf-Metallstifte Ø 1,6 mm

► MB 1.471

DGH-M 2018, HDE-de, 06/18; Maßangaben unverbindlich. Konstruktionsänderungen vorbehalten.



1



Möbelgriffe zeitlos

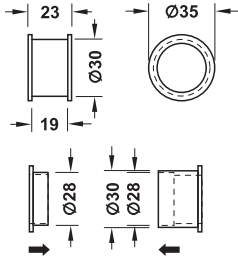

> Montage: schraubenlose Befestigung zum Kleben

Oberfläche	Artikel-Nr.
verchromt matt	151.79.400

Abpackung: 1 oder 10 Stück

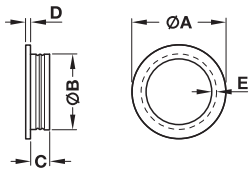

> Werkstoff: Messing

Oberfläche	Maß A mm	Maß B mm	Maß C mm	Maß D mm	Maß E mm	Abpackung Stück	Artikel-Nr.
verchromt poliert	40	35	10	2	2	1 oder 40	155.01.555
	48.5	40	10	2	2	1 oder 30	155.01.560
	59	54	12.5	2.5	6	1 oder 40	155.01.565
vernickelt matt	40	35	10	2	2	1 oder 40	155.01.556
	48.5	40	10	2	2	1 oder 30	155.01.561
	59	54	12.5	2.5	6	1 oder 40	155.01.566
matt	40	35	10	2	2	1 oder 40	155.01.557
	48.5	40	10	2	2	1 oder 30	155.01.562
	59	54	12.5	2.5	6	1 oder 40	155.01.567

DGH-M 2018; HDE-de, 06/18; Maßangaben unverbindlich. Konstruktionsänderungen vorbehalten.

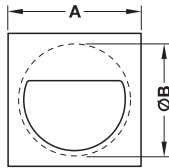
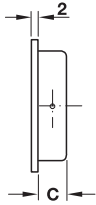

> Oberfläche: vernickelt matt

Maß A mm	Maß B mm	Maß C mm	Artikel-Nr.
45	40	15	151.40.717
70	60	15	151.40.726

Abpackung: 1 oder 10 Stück

Rundkopf-Metallstifte Ø 0,9 mm

► MB 1.471

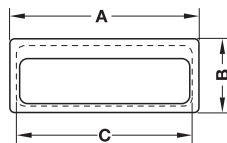
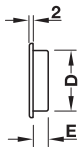

> Montage: schraubenlose Befestigung mit Leimrillen

Oberfläche	Maß A mm	Maß B mm	Maß C mm	Maß D mm	Maß E mm	Abpackung Stück	Artikel-Nr.
vernickelt poliert	75	32	68	25	10	1 oder 50	155.01.545
	99	38	92	31	12	1 oder 30	155.01.546
poliert innen: matt	75	32	68	25	10	1 oder 50	155.01.550
	99	38	92	31	12	1 oder 30	155.01.551

DGH-M 2018, HIDE-de, 06/18; Maßangaben unverbindlich. Konstruktionsänderungen vorbehalten.

1

Möbelgriffe zeitlos

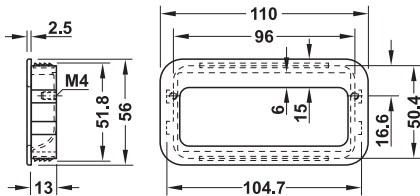
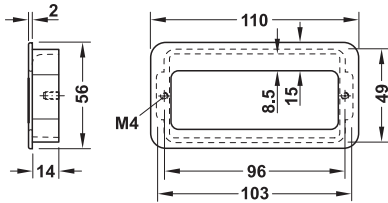

Oberfläche	Artikel-Nr.
verchromt matt	155.00.565

Abpackung: 1 oder 10 Stück

> Montage: Befestigung mit Harpunensteg

Oberfläche	Artikel-Nr.
verchromt matt	155.00.560
vernickelt matt	155.00.555

Abpackung: 1 oder 10 Stück

Gewindeschrauben M4

► MB 1.470

DGH-M 2018; HDE-de, 06/18; Maßangaben unverbindlich. Konstruktionsänderungen vorbehalten.

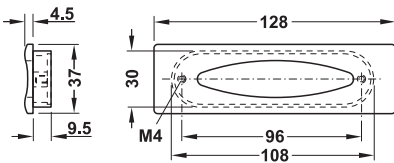
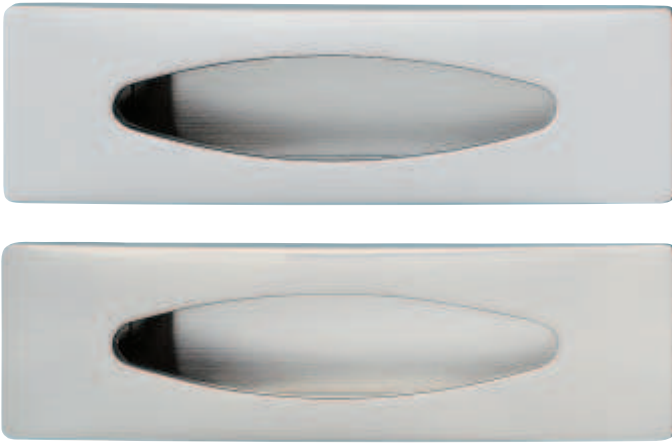

Oberfläche	Artikel-Nr.
verchromt matt	151.74.402
edelstahlfarben	151.74.002

Abpackung: 1 oder 12 Stück

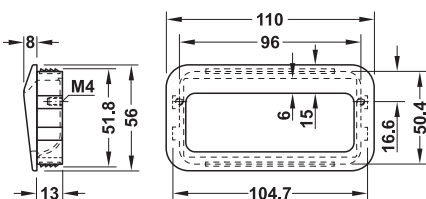

> Montage: Befestigung mit Harpunensteg

Oberfläche	Artikel-Nr.
verchromt poliert	155.00.545
verchromt matt	155.00.550
vernickelt matt	155.00.540

Abpackung: 1 oder 10 Stück

Gewindeschrauben M4 ▶ MB 1.470

DGH-M 2018, HIDE-de, 06/18; Maßangaben unverbindlich. Konstruktionsänderungen vorbehalten.

1

GAEB

CAD

Möbelgriffe zeitlos

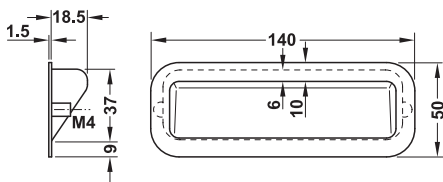

<b>Oberfläche</b>	<b>Artikel-Nr.</b>
aluminiumfarben	152.14.902
Abpackung: 1 oder 25 Stück	
Gewindeschrauben M4	► MB 1.470

Fräsmaß

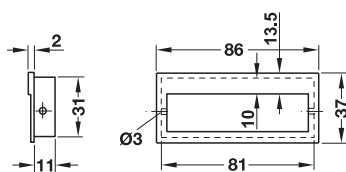
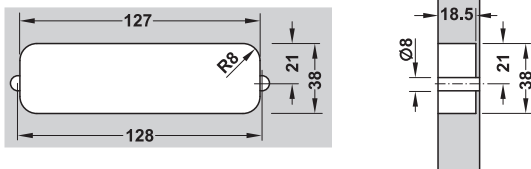

> Werkstoff:	Griff: Zinkdruckguss, Rückteil: Stahl
--------------	--

<b>Oberfläche</b>	<b>Artikel-Nr.</b>
Griff: vernickelt matt Rückteil: schwarz matt	151.09.600
Abpackung: 1 oder 25 Stück	
Linsenkopfschrauben DIN 95 Ø 2,5 mm	► MB 1.471

DGH-M 2018; HDE-de, 06/18; Maßangaben unverbindlich. Konstruktionsänderungen vorbehalten.

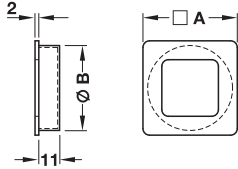

> Montage: schraubenlose Befestigung, zum Kleben

Oberfläche	Maß A mm	Maß B mm	Artikel-Nr.
verchromt matt	39	35	155.00.000
	50	45	155.00.001
vernickelt gebürstet	39	35	155.00.010
	50	45	155.00.011

Abpackung: 1 oder 50 Stück

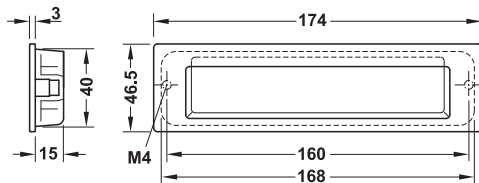
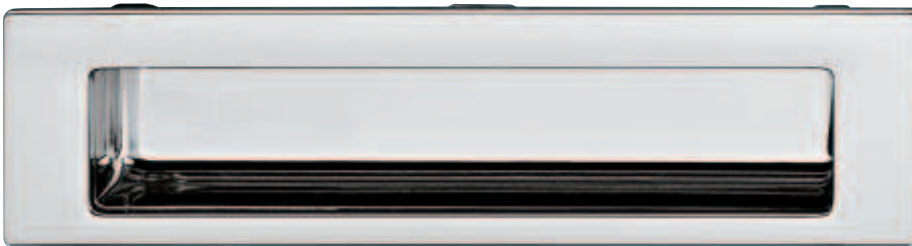

Oberfläche	Artikel-Nr.
verchromt poliert	106.59.210
verchromt matt	106.59.410

Abpackung: 1 oder 25 Stück

Gewindeschrauben M4

► MB 1.470

1

Möbelgriffe zeitlos

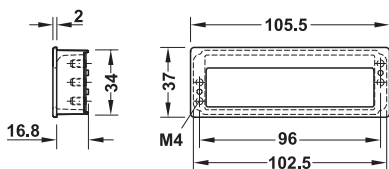
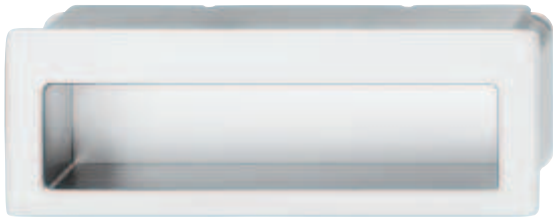

Oberfläche/Farbe	Artikel-Nr.
verchromt poliert	155.00.275
verchromt matt	155.00.270
vermessingt gebürstet	155.01.794

Abpackung: 1, 10 oder 60 Stück

Gewindeschrauben M4

► MB 1.470

DGH-M 2018; HDE-de, 06/18; Maßangaben unverbindlich. Konstruktionsänderungen vorbehalten.



**DIESE SEITE WURDE BEWUSST  
LEER GELASSEN**

**INTENTIONAL BLANK PAGE**

1

Möbelgriffe zeitlos

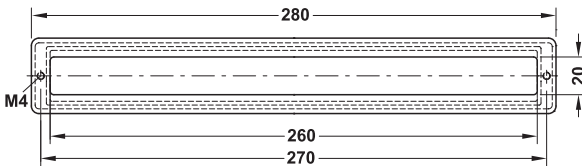
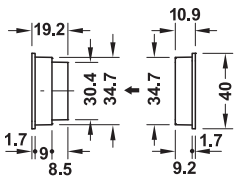

Oberfläche	Artikel-Nr.
edelstahlfarben	151.11.620
schwarz matt	151.11.621

Abpackung: 1 oder 10 Stück

Gewindeschrauben M4

► MB 1.470

DGH-M 2018; HDE-de, 06/18; Maßangaben unverbindlich. Konstruktionsänderungen vorbehalten.

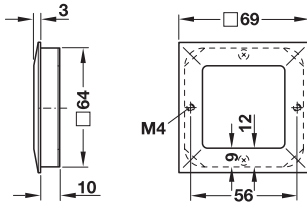

Oberfläche/Farbe	Artikel-Nr.
aluminiumfarben	155.00.020
vernickelt gebürstet	155.00.030

Abpackung: 1 oder 30 Stück

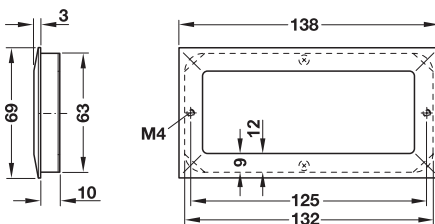

Oberfläche	Artikel-Nr.
aluminiumfarben	155.00.021
vernickelt gebürstet	155.00.031

Abpackung: 1 oder 10 Stück

Gewindeschrauben M4

► MB 1.470

DGH-M 2018, HIDE-de, 06/18; Maßangaben unverbindlich. Konstruktionsänderungen vorbehalten.

1



Möbelgriffe zeitlos

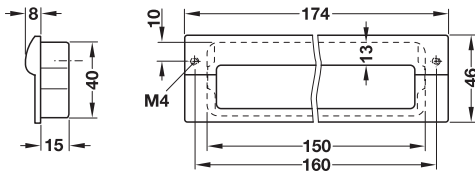

Oberfläche	Artikel-Nr.
aluminiumfarben	155.00.230
vernickelt matt	155.00.240

Abpackung: 1 oder 5 Stück

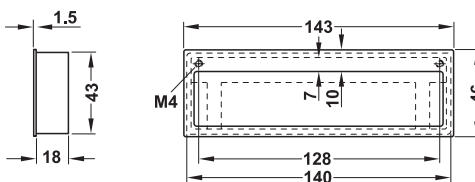
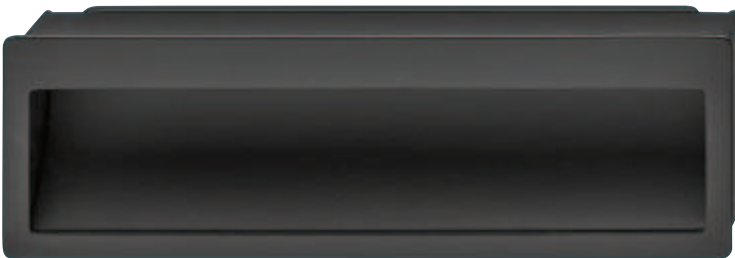
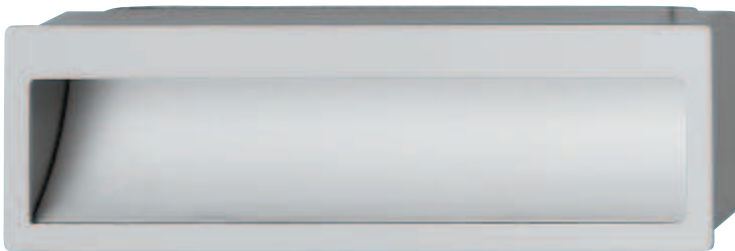

Oberfläche	Artikel-Nr.
aluminiumfarben	151.11.903
edelstahlfarben	151.11.603
schwarz matt	151.11.604

Abpackung: 1 oder 25 Stück

Gewindeschrauben M4

► MB 1.470

DGH-M 2018; HDE-de, 06/18; Maßangaben unverbindlich. Konstruktionsänderungen vorbehalten.

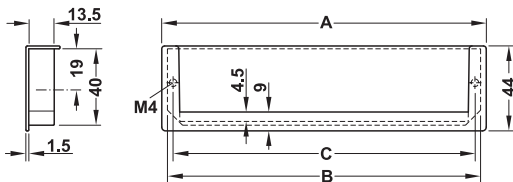

Oberfläche	Maß A mm	Maß B mm	Maß C mm	Artikel-Nr.
aluminiumfarben	172	167	160	151.47.900

Abpackung: 1 oder 20 Stück

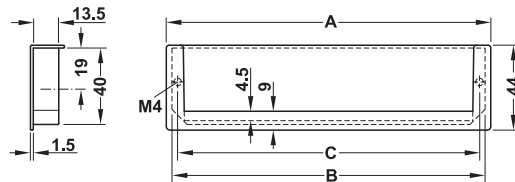

Oberfläche	Maß A mm	Maß B mm	Maß C mm	Artikel-Nr.
braun durchgerieben	140	135	128	151.49.980
verkupfert durchgerieben	140	135	128	151.49.981
verzinkt antik	140	135	128	151.49.982

Abpackung: 1 oder 25 Stück

Gewindeschrauben M4

► MB 1.470

1



Möbelgriffe zeitlos

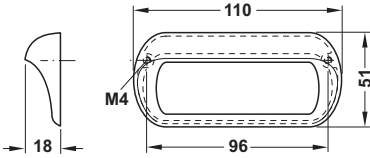

Oberfläche	Artikel-Nr.
verchromt matt	151.33.213

Abpackung: 1 oder 25 Stück

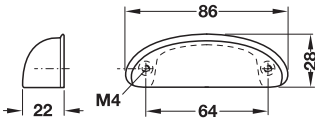

Oberfläche	Artikel-Nr.
vernickelt gebürstet	105.55.600

Abpackung: 1 oder 50 Stück

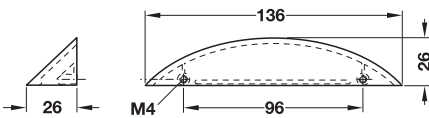

Oberfläche	Artikel-Nr.
vernickelt matt	105.47.600

Abpackung: 1 oder 25 Stück

Gewindeschrauben M4

► MB 1.470

DGH-M 2018; HDE-de, 06/18; Maßangaben unverbindlich. Konstruktionsänderungen vorbehalten.

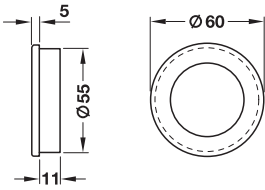

- > Werkstoff: Buche
- > Montage: schraubenlose Befestigung zum Kleben

Oberfläche	Artikel-Nr.
natur	191.67.303

Abpackung: 1 oder 25 Stück

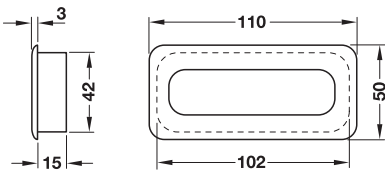

- > Oberfläche: natur
- > Montage: schraubenlose Befestigung zum Kleben

Werkstoff	Artikel-Nr.
Eiche	192.29.406
Buche	192.29.300

Abpackung: 1 oder 25 Stück



1



Möbelgriffe zeitlos

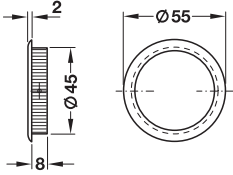

> Werkstoff: Kunststoff

Farbe	Artikel-Nr.
schwarz	158.20.630

Abpackung: 1 oder 50 Stück

Rundkopf-Metallstifte Ø 1,6 mm ▶ MB 1.471

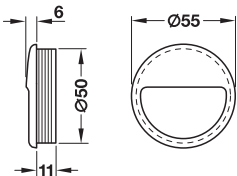

Oberfläche/Farbe	Artikel-Nr.
verchromt poliert, innen: schwarz	158.23.211
weiß	158.23.702
schwarz	158.23.300

Abpackung: 1 oder 25 Stück

Rundkopf-Metallstifte Ø 1,6 mm ▶ MB 1.471

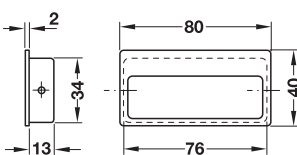

Farbe	Artikel-Nr.
weiß	129.57.701
schwarz	129.57.603

Abpackung: 1 oder 100 Stück

Holzschrauben Senkkopf Ø 2,5 mm ▶ MB 1.471

DGH-M 2018; HDE-de, 06/18; Maßangaben unverbindlich. Konstruktionsänderungen vorbehalten.

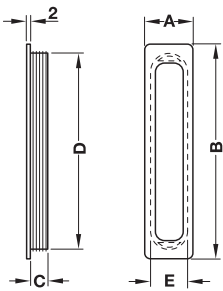
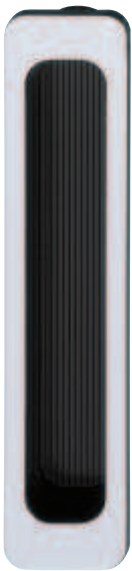

> Oberfläche/ Farbe: silberfarben matt, innen: schwarz  
> Montage: schraubenlose Befestigung mit Leimrillen

Maß A mm	Maß B mm	Maß C mm	Maß D mm	Maß E mm	Artikel-Nr.
26	85	9	75	20	158.42.921
26	116	9	110	20	158.43.928

Abpackung: 1 oder 100 Stück

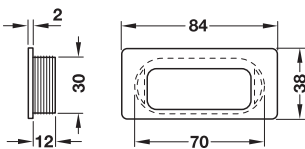

> Montage: schraubenlose Befestigung mit Leimrillen

Oberfläche/Farbe	Artikel-Nr.
silberfarben matt, innen schwarz	158.44.925

Abpackung: 1 oder 100 Stück

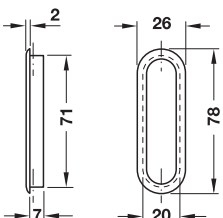

Farbe	Artikel-Nr.
weiß	158.03.737
schwarz	158.03.639

Abpackung: 1 oder 500 Stück

DGH-M 2018, HIDE-de, 06/18; Maßangaben unverbindlich. Konstruktionsänderungen vorbehalten.

1

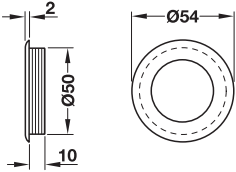
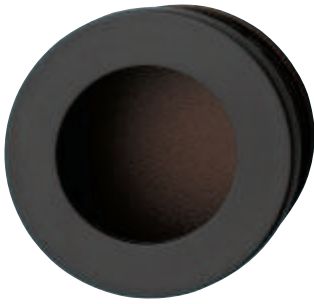

> Werkstoff: Kunststoff  
> Montage: schraubenlose Befestigung mit Leimrillen

Farbe	Artikel-Nr.
dunkelbraun	158.37.108

Abpackung: 1 oder 100 Stück

Möbelgriffe zeitlos

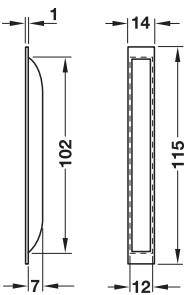

> Montage: schraubenlose Befestigung mit Leimrillen

Farbe	Artikel-Nr.
weiß	158.05.704
braun	158.05.106

Abpackung: 1 oder 500 Stück

Rundkopf-Metallstifte Ø 1,6 mm

► MB 1.471

DGH-M 2018; HDE-de, 06/18; Maßangaben unverbindlich. Konstruktionsänderungen vorbehalten.

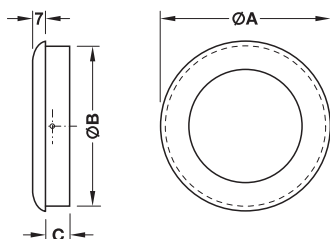

> Werkstoff: Polyamid

Maß A mm	Maß B mm	Maß C mm	verfügbare Farben ab Lager	Artikel-Nr.
<b>glänzend</b>				
60	55	13	33, 90, 92, 95, 97, 99	158.80.1**
75	70	13	90, 92, 95, 99	158.80.2**
<b>matt</b>				
60	55	13	–	158.80.0**

Abpackung: 1 Stück

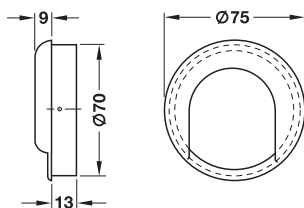

Werkstoff	verfügbare Farben ab Lager	Artikel-Nr.
Polyamid	33, 50, 90, 99	158.75.0**

Abpackung: 1 Stück

**Bestellhinweis**

Bei Bestellung ersetzen Sie bitte die \*\* durch die Farb-Nummer Ihrer Wahl.

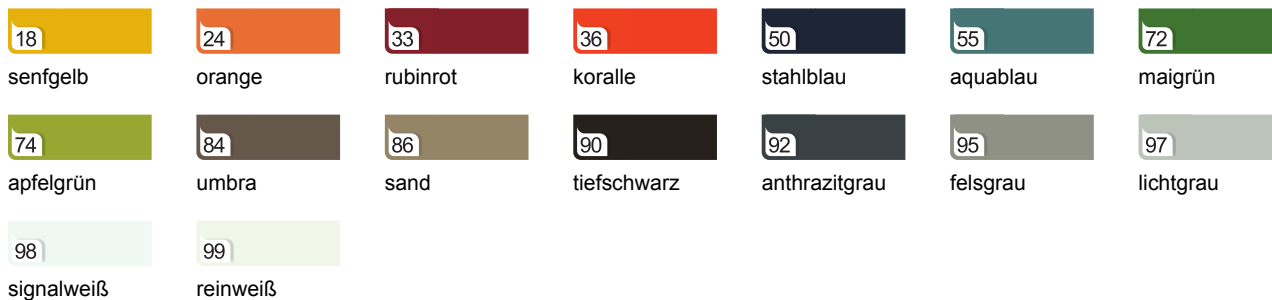

Holzschrauben Senkkopf Ø 2,5 mm

► MB 1.471

DGH-M 2018, HDE-de, 06/18; Maßangaben unverbindlich. Konstruktionsänderungen vorbehalten.

Möbelgriffe zeitlos

1

Möbelgriffe zeitlos

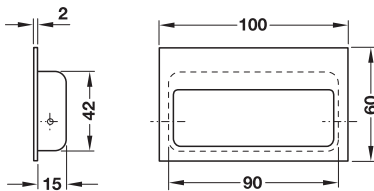

Werkstoff	verfügbare Farben ab Lager	Artikel-Nr.
<b>glänzend</b>		
Polyamid	33, 90, 92, 95, 97, 99	158.88.0**
<b>matt</b>		
Polyamid	–	158.88.1**

Abpackung: 1 Stück

**Bestellhinweis**

Bei Bestellung ersetzen Sie bitte die \*\* durch die Farb-Nummer Ihrer Wahl.

<b>18</b> senfgelb	<b>24</b> orange	<b>33</b> rubinrot	<b>36</b> koralle	<b>50</b> stahlblau	<b>55</b> aquablau	<b>72</b> maigrün
<b>74</b> apfelgrün	<b>84</b> umbra	<b>86</b> sand	<b>90</b> tiefschwarz	<b>92</b> anthrazitgrau	<b>95</b> felsgrau	<b>97</b> lichtgrau
<b>98</b> signalweiß	<b>99</b> reinweiß					

Holzschrauben Senkkopf Ø 2,5 mm

► MB 1.471

DGH-M 2018; HDE-de, 06/18; Maßangaben unverbindlich. Konstruktionsänderungen vorbehalten.

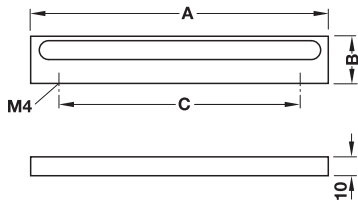

**topCo** KUNDENINDIVIDUELL  
BEREITS AB EINEM STÜCK

Diese Griffe 100.65.000–004 (bis max. Lochabstand 192 mm) sind auch mit einer Logo-Beschriftung auf der breiten Griff-Fläche erhältlich.

> Werkstoff: Edelstahl, Güte 1.4301  
> Oberfläche: matt gebürstet  
> Ausführung: Vollmaterial

Maß A mm	Maß B mm	Maß C mm	Artikel-Nr.
94	25	64	100.65.000
126	25	96	100.65.001
158	25	128	100.65.002
190	25	160	100.65.003
222	25	192	100.65.004
254	25	224	100.65.005
382	25	352	100.65.009
478	25	448	100.65.012

Abpackung: 1 oder 10 Stück

Laser-Beschriftung ▶ MB 1.206

### Möbelgriff – Topco

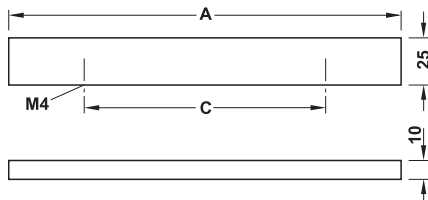

**topCo** KUNDENINDIVIDUELL  
BEREITS AB EINEM STÜCK

Folgende Eigenschaften können Sie wählen:

- > Grifflänge (Maß A)
- > Lochabstand (Maß C, ggf. C1)

> Werkstoff: Edelstahl, Güte 1.4301  
> Oberfläche: matt gebürstet

Länge mm	Artikel-Nr.
Fixlänge (bis 2.000 mm)	100.65.059

Abpackung: 1 Stück

**Bestellhinweis**

Bei Länge 720 mm sind 3 Bohrungen mit Abstand C1 zur Befestigung notwendig.

Passende Möbelfüße ▶ MB 12.61

Gewindeschrauben M4 ▶ MB 1.470

DGH-M 2018, HDE-de, 06/18; Maßangaben unverbindlich. Konstruktionsänderungen vorbehalten.

1

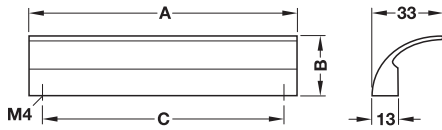

> Oberfläche: silberfarben eloxiert

Maß A mm	Maß B mm	Maß C mm	Artikel-Nr.
44	32	32	110.56.921
108	32	96	110.56.940
140	32	128	110.56.922

Abpackung: 1 oder 25 Stück

Möbelgriffe zeitlos

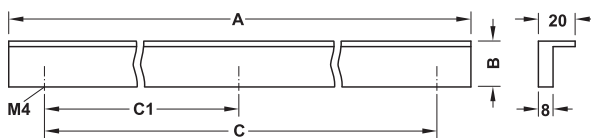

Oberfläche	Maß A mm	Maß B mm	Maß C mm	Maß C1 mm	Abpackung Stück	Artikel-Nr.
silberfarben eloxiert	136	25	96	–	1 oder 10	112.83.900
	168	25	128	–	1 oder 10	112.83.902
	200	25	160	–	1 oder 10	112.83.903
	232	25	192	–	1 oder 10	112.83.904
	300	25	260	–	1 oder 30	112.83.906
	400	25	360	–	1 oder 30	112.83.909
	500	25	460	–	1 oder 30	112.83.910
	1000	25	960	480	1 oder 10	112.83.911
edelstahl-farben	136	25	96	–	1 oder 10	112.83.000
	168	25	128	–	1 oder 10	112.83.002
	200	25	160	–	1 oder 10	112.83.003
	232	25	192	–	1 oder 10	112.83.004
	300	25	260	–	1 oder 30	112.83.006
	400	25	360	–	1 oder 30	112.83.009
	500	25	460	–	1 oder 30	112.83.010
	1000	25	960	480	1 oder 10	112.83.015

Gewindeschrauben M4

► MB 1.470

DGH-M 2018; HDE-de, 06/18; Maßangaben unverbindlich. Konstruktionsänderungen vorbehalten.



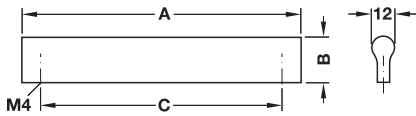

> Oberfläche/Farbe: silberfarben eloxiert

Maß A mm	Maß B mm	Maß C mm	Artikel-Nr.
52	24	32	155.01.100
84	24	64	155.01.115
116	24	96	155.01.101
148	24	128	155.01.102
180	24	160	155.01.103
212	24	192	155.01.104
244	24	224	155.01.105
308	24	288	155.01.106
372	24	352	155.01.107

Abpackung: 1 oder 25 Stück

## Möbelgriff – Topco

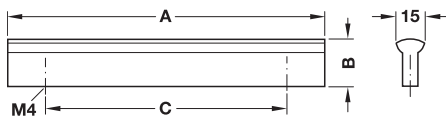

> Oberfläche: silberfarben eloxiert

Maß A mm	Maß B mm	Maß C mm	Abpackung Stück	Artikel-Nr.
104	25	64	1 oder 10	103.89.901
136	25	96	1 oder 10	103.89.902
168	25	128	1 oder 10	103.89.903
200	25	160	1 oder 10	103.89.904
232	25	192	1 oder 10	103.89.905
328	25	288	1 oder 10	103.89.908
392	25	352	1 oder 10	103.89.910
488	25	448	1 oder 10	103.89.913
600	25	560	1	103.89.914
700	25	660	1	103.89.915
1000	25	960	1	103.89.918

### Hinweis

Maß A = 1000 mm wird mit 3 Gewindebohrungen geliefert.

**topCo** KUNDENINDIVIDUELL  
BEREITS AB EINEM STÜCK

Die Griffe 103.89.901–905 sind auch mit einer Logo-Beschriftung auf der flachen Seite des Griffes erhältlich.

Laser-Beschriftung	► MB 1.206
Passender Möbelknopf	► MB 1.272

Gewindeschrauben M4	► MB 1.470
---------------------	------------

DGH-M 2018, HIDE-de, 06/18; Maßangaben unverbindlich. Konstruktionsänderungen vorbehalten.

1

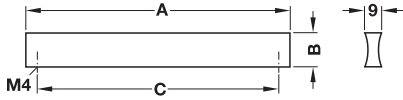

> Oberfläche/Farbe: silberfarben eloxiert

Maß A mm	Maß B mm	Maß C mm	Artikel-Nr.
44	18	32	155.01.110
76	18	64	155.01.111
108	18	96	155.01.112
140	18	128	155.01.113
332	18	320	155.01.114

Abpackung: 1 oder 25 Stück

Möbelgriffe zeitlos

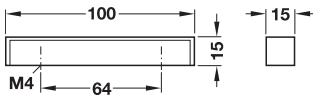

Oberfläche	Artikel-Nr.
silberfarben eloxiert	110.70.901

Abpackung: 1 oder 50 Stück

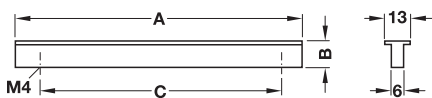

> Oberfläche: silberfarben eloxiert

Maß A mm	Maß B mm	Maß C mm	Abpackung Stück	Artikel-Nr.
50	14	32	1 oder 100	107.24.903
80	14	64	1 oder 100	107.24.900
120	14	96	1 oder 50	107.24.901
150	14	128	1 oder 40	107.24.902
220	14	192	1 oder 50	107.24.904

Gewindeschrauben M4

► MB 1.470

DGH-M 2018; HDE-de, 06/18; Maßangaben unverbindlich. Konstruktionsänderungen vorbehalten.

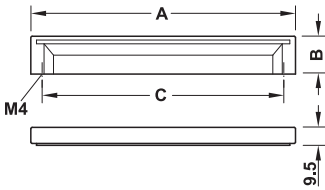
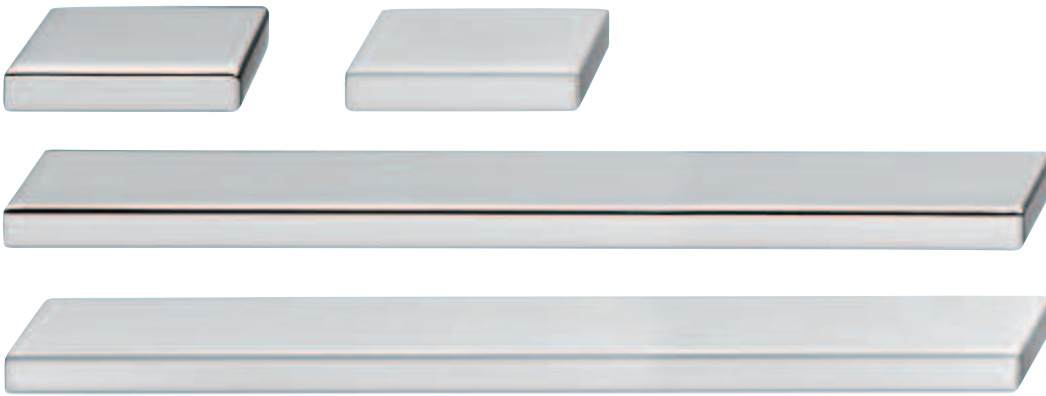

Oberfläche	Maß A mm	Maß B mm	Maß C mm	Artikel-Nr.
verchromt poliert	43	20	32	111.44.200
	140	20	128	111.44.202
	202	20	192	111.44.204
verchromt matt	43	20	32	111.44.400
	140	20	128	111.44.402
	202	20	192	111.44.404

Abpackung: 1 oder 10 Stück

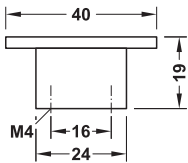

Oberfläche	Artikel-Nr.
vernickelt gebürstet	155.00.350

Abpackung: 1 oder 25 Stück

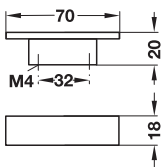

Oberfläche	Artikel-Nr.
verchromt matt	155.00.250
vernickelt gebürstet	155.00.260

Abpackung: 1 oder 25 Stück

DGH-M 2018, HIDE-de, 06/18; Maßangaben unverbindlich. Konstruktionsänderungen vorbehalten.

Gewindeschrauben M4

► MB 1.470

1



Möbelgriffe zeitlos

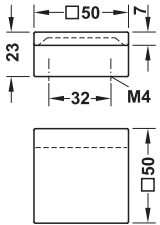

Oberfläche	Artikel-Nr.
verchromt matt	110.24.452
vernickelt matt gebürstet	110.24.652

Abpackung: 1 oder 10 Stück

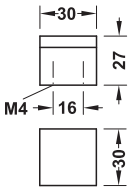

Oberfläche/Farbe	Artikel-Nr.
verchromt poliert	110.24.201
verchromt matt	110.24.401
vernickelt matt	110.24.601
vernickelt gebürstet	110.24.001

Abpackung: 1 oder 25 Stück

Gewindeschrauben M4

► MB 1.470

DGH-M 2018; HDE-de, 06/18; Maßangaben unverbindlich. Konstruktionsänderungen vorbehalten.

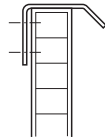
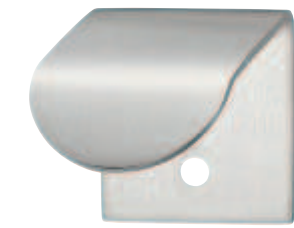

> Werkstoff: Edelstahl, Güte 1.4301

Oberfläche	Artikel-Nr.
matt gebürstet	100.57.000

Abpackung: 1 oder 10 Stück

Spanplattenschrauben Hospa Senkkopf Ø 3,5 mm ▶ MB 1.470

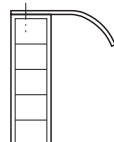
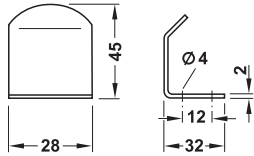

> Werkstoff: Edelstahl, Güte 1.4301

Oberfläche	Artikel-Nr.
matt gebürstet	115.89.011

Abpackung: 1 oder 10 Stück

Spanplattenschrauben Hospa Senkkopf Ø 2,5 mm ▶ MB 1.470

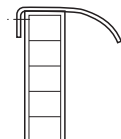
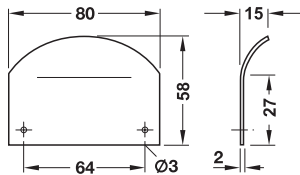

> Werkstoff: Edelstahl, Güte 1.4301

Oberfläche	Artikel-Nr.
matt gebürstet	115.89.001

Abpackung: 1 oder 10 Stück

Spanplattenschrauben Hospa Senkkopf Ø 2,5 mm ▶ MB 1.470

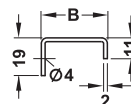
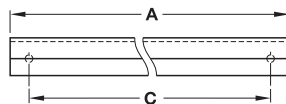
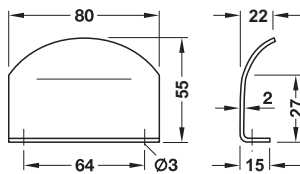

> Werkstoff: Edelstahl, Güte 1.4301  
> Oberfläche: matt

Maß A mm	Maß B mm	Maß C1 mm	Maß C mm	Artikel-Nr.
50	36	–	30	115.98.000
100	36	–	80	115.98.001
200	36	–	180	115.98.004
300	36	–	280	115.98.007
400	36	190	380	115.98.009

Abpackung: 1 oder 10 Stück

Spanplattenschrauben Hospa Senkkopf Ø 3,5 mm ▶ MB 1.470

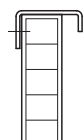

**Hinweis**

Bei Länge 400 mm sind 3 Bohrungen mit Abstand C1 zur Befestigung notwendig.

1



Möbelgriffe zeitlos

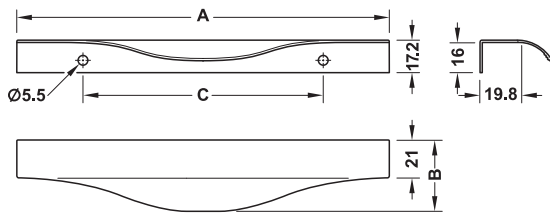

Oberfläche/Farbe	Maß A mm	Maß B mm	Maß C mm	Artikel-Nr.
edelstahlfarben	200	38	128	126.14.605
	350	38	256	126.14.608
bronzefarben, antik	200	38	128	126.45.046
	350	38	256	126.45.049
hell eloxiert	200	38	128	126.45.965
	350	38	256	126.45.969

Abpackung: 1 oder 25 Stück

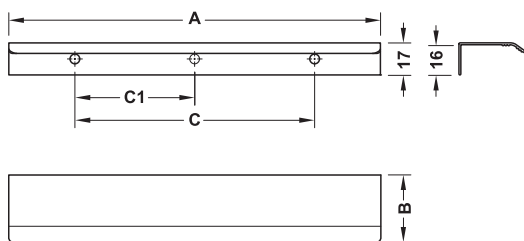

> Oberfläche: edelstahlfarben

Maß A mm	Maß B mm	Maß C mm	Maß C1 mm	Abpackung Stück	Artikel-Nr.
45	36	32	–	1, 40 oder 640	155.01.120
100	36	64	–	1, 50 oder 400	155.01.121
200	36	128	–	1, 50 oder 200	155.01.122
300	36	192	–	1, 50 oder 200	155.01.123
400	36	320	160	1, 50 oder 200	155.01.124
500	36	416	208	1, 50 oder 200	155.01.125

Spanplattenschrauben Hospa Senkkopf Ø 5 mm ► MB 14.39

DGH-M 2018; HDE-de, 06/18; Maßangaben unverbindlich. Konstruktionsänderungen vorbehalten.

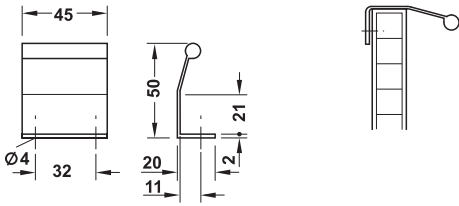
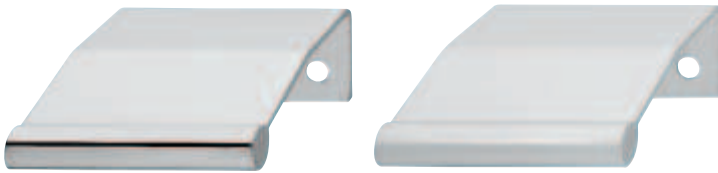

Oberfläche	Artikel-Nr.
verchromt poliert	124.40.240
verchromt matt	124.40.440

Abpackung: 1 oder 50 Stück

Spanplattenschrauben Hospa Senkkopf Ø 4 mm ▶ MB 1.470

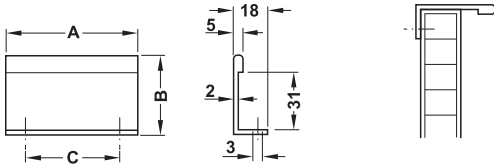
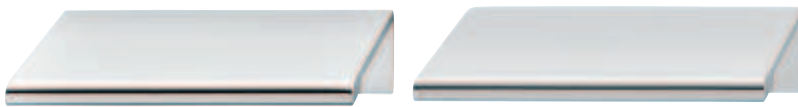

> Befestigungsmaterial im Lieferumfang enthalten

Oberfläche	Maß A mm	Maß B mm	Maß C mm	Artikel-Nr.
hochglanzpoliert	40	42	25	124.02.210
	70	42	50	124.02.220
silberfarben eloxiert	40	42	25	124.02.911
	70	42	50	124.02.921

Abpackung: 1 oder 40 Stück

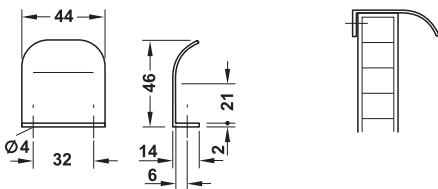

Oberfläche	Artikel-Nr.
verchromt poliert	124.41.202
verchromt matt	124.41.402
vernickelt matt	124.41.602

Abpackung: 1 oder 10 Stück

Spanplattenschrauben Hospa Senkkopf Ø 4 mm ▶ MB 1.470

DGH-M 2018, HDE-de, 06/18; Maßangaben unverbindlich. Konstruktionsänderungen vorbehalten.



1



Möbelgriffe zeitlos

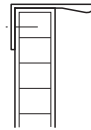
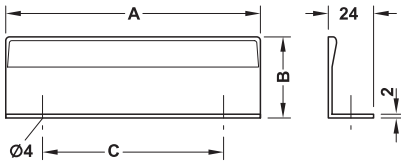

Oberfläche	Maß A mm	Maß B mm	Maß C mm	Abpackung Stück	Artikel-Nr.
verchromt poliert	71	44	32	1 oder 25	124.02.230
	135	44	96	1 oder 25	124.02.231
	230	44	192	1 oder 20	124.02.234
vernickelt gebürstet	71	44	32	1 oder 25	124.02.630
	135	44	96	1 oder 25	124.02.631
	230	44	192	1 oder 20	124.02.634

Spanplattenschrauben Hospa Senkkopf Ø 3,5 mm ► MB 1.470

DGH-M 2018; HDE-de, 06/18; Maßangaben unverbindlich. Konstruktionsänderungen vorbehalten.

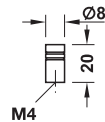
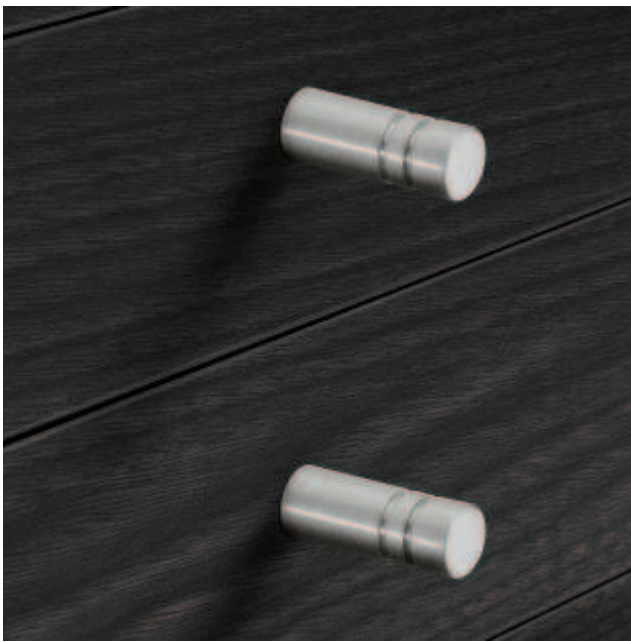

> Werkstoff: Edelstahl, Güte 1.4305/AISI 303

Oberfläche	Artikel-Nr.
matt gebürstet	132.94.050

Abpackung: 1 oder 100 Stück

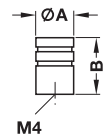

> Werkstoff: Edelstahl, Güte 1.4301/AISI 304  
> Oberfläche: matt gebürstet

Maß A mm	Maß B mm	Abpackung Stück	Artikel-Nr.
15	30	1 oder 30	155.01.480
20	30	1 oder 20	155.01.481

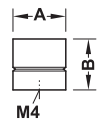

> Werkstoff: Edelstahl, Güte 1.4301/AISI 304  
> Oberfläche: matt

Maß A mm	Maß B mm	Artikel-Nr.
28	28	134.88.610

Abpackung: 1 oder 25 Stück

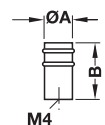
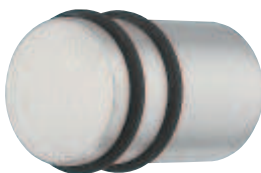

> Werkstoff: Edelstahl, Güte 1.4305/AISI 303  
> Oberfläche: Knopf: matt gebürstet, Gummiringe: schwarz

Maß A mm	Maß B mm	Artikel-Nr.
15	30	134.86.610
20	30	134.86.620

Abpackung: 1 oder 10 Stück

DGH-M 2018, HIDE-de, 06/18; Maßangaben unverbindlich. Konstruktionsänderungen vorbehalten.

Gewindeschrauben M4 ▶ MB 1.470

1

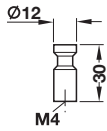

Werkstoff	Oberfläche/ Farbe	Artikel-Nr.
Edelstahl, Güte 1.4305/AISI 303	matt gebürstet	134.82.605
Aluminium	schwarz eloxiert	134.82.610

Abpackung: 1 oder 10 Stück

Möbelknöpfe zeitlos

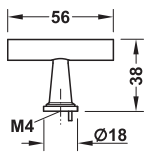

> Werkstoff:	Edelstahl, Güte 1.4305/AISI 303
--------------	---------------------------------

Oberfläche	Artikel-Nr.
matt gebürstet	131.33.000

Abpackung: 1 oder 10 Stück

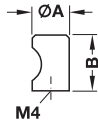

> Werkstoff:	Edelstahl, Güte 1.4301/AISI 304
--------------	---------------------------------

Oberfläche/Farbe	Maß A mm	Maß B mm	Abpackung Stück	Artikel-Nr.
matt gebürstet	12	25	1 oder 40	155.01.485
	20	30	1 oder 20	155.01.486
vermessingt poliert, PVD beschichtet	12	25	1 oder 40	112.02.102
	20	30	1 oder 20	112.02.103
schwarz, matt, PVD beschichtet	12	25	1 oder 40	112.02.104
	20	30	1 oder 20	112.02.105

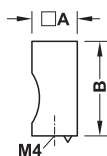

> Werkstoff:	Edelstahl, Güte 1.4301/AISI 304
--------------	---------------------------------

Oberfläche/Farbe	Maß A mm	Maß B mm	Artikel-Nr.
matt gebürstet	12	25	112.02.110
	20	30	112.02.111
vermessingt poliert, PVD beschichtet	12	25	112.02.112
	20	30	112.02.113
schwarz, matt, PVD beschichtet	12	25	112.02.114
	20	30	112.02.115

Abpackung: 1 oder 40 Stück

Gewindeschrauben M4

► MB 1.470

DGH-M 2018; HDE-de, 06/18; Maßangaben unverbindlich. Konstruktionsänderungen vorbehalten.

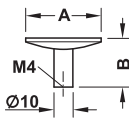

- > Werkstoff: Edelstahl, Güte 1.4305
- > Oberfläche: matt gebürstet

Maß A mm	Maß B mm	Artikel-Nr.
33	24	134.81.030

Abpackung: 1 oder 10 Stück

Passende Garderobenhaken

► MB 1.423

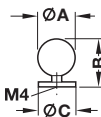
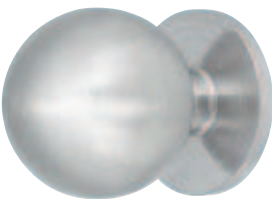

- > Werkstoff: Edelstahl, Güte 1.4305
- > Oberfläche: matt gebürstet

Maß A mm	Maß B mm	Maß C mm	Artikel-Nr.
20	27	20	135.13.601
25	32	25	135.13.602
30	38	30	135.13.603

Abpackung: 1 oder 10 Stück

Gewindeschrauben M4

► MB 1.470

1



Möbelknöpfe zeitlos

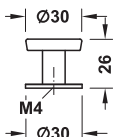
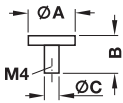
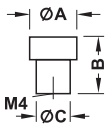
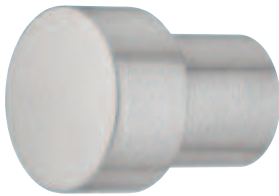

> Werkstoff: Edelstahl, Güte 1.4305  
> Oberfläche: matt gebürstet

Maß A mm	Maß B mm	Maß C mm	Artikel-Nr.
20	30	14	134.81.041
25	30	18	134.81.042

Abpackung: 1 oder 10 Stück

Passende Garderobenhaken ▶ MB 1.417

> Werkstoff: Edelstahl, Güte 1.4305  
> Oberfläche: matt gebürstet

Maß A mm	Maß B mm	Maß C mm	Artikel-Nr.
25	22	10	134.81.617
32	25	10	134.81.626

Abpackung: 1 oder 10 Stück

> Werkstoff: Edelstahl, Güte 1.4305

Oberfläche	Artikel-Nr.
matt gebürstet	131.32.010

Abpackung: 1 oder 10 Stück

Gewindeschrauben M4 ▶ MB 1.470

DGH-M 2018; HDE-de, 06/18; Maßangaben unverbindlich. Konstruktionsänderungen vorbehalten.

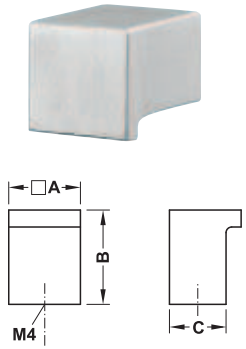

> Werkstoff: Edelstahl, Güte 1.4301/AISI 304  
> Oberfläche: matt gebürstet

Maß A mm	Maß B mm	Maß C mm	Abpackung Stück	Artikel-Nr.
12	20	9	1 oder 100	155.01.520
16	25	12	1 oder 100	155.01.521
19	25	15	1 oder 80	155.01.522
25	30	25	1 oder 50	155.01.525

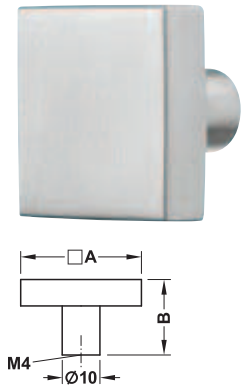

> Werkstoff: Edelstahl, Güte 1.4301/AISI 304  
> Oberfläche: matt gebürstet

Maß A mm	Maß B mm	Abpackung Stück	Artikel-Nr.
19	20	1 oder 100	155.01.515
25	20	1 oder 80	155.01.516
32	20	1 oder 60	155.01.517

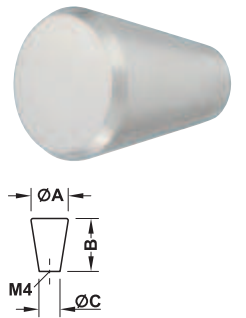

> Werkstoff: Edelstahl, Güte 1.4301/AISI 304  
> Oberfläche: matt gebürstet

Maß A mm	Maß B mm	Maß C mm	Abpackung Stück	Artikel-Nr.
12	20	7	1 oder 120	155.01.510
16	26	9	1 oder 100	155.01.511
20	28	11	1 oder 100	155.01.512

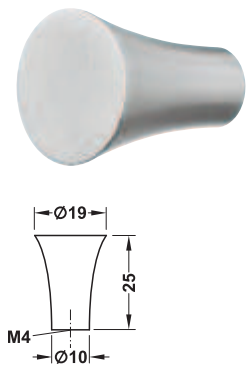

> Werkstoff: Edelstahl, Güte 1.4301/AISI 304

Oberfläche/Farbe	Artikel-Nr.
matt gebürstet	155.01.526

Abpackung: 1 oder 80 Stück

DGH-M 2018, HIDE-de, 06/18; Maßangaben unverbindlich. Konstruktionsänderungen vorbehalten.

Gewindeschrauben M4 ▶ FF 1.260

1

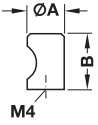

> Werkstoff: Aluminium

Oberfläche	Maß A mm	Maß B mm	Artikel-Nr.
silberfarben eloxiert	12	25	155.01.070
	15	27	155.01.075
	20	30	155.01.080
schwarz eloxiert	12	25	135.71.910
	20	30	135.71.911

Abpackung: 1 oder 10 Stück

Möbelknöpfe zeitlos

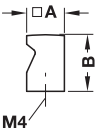

> Werkstoff: Aluminium  
> Oberfläche: silberfarben eloxiert

Maß A mm	Maß B mm	Artikel-Nr.
15	22	155.01.085
20	30	155.01.090

Abpackung: 1 oder 100 Stück

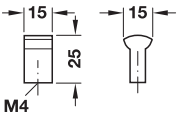
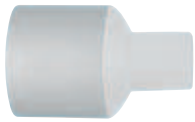

Oberfläche	Artikel-Nr.
silberfarben eloxiert	135.08.900

Abpackung: 1 oder 10 Stück

Passender Steggriff ▶ MB 1.259

Gewindeschrauben M4 ▶ MB 1.470

DGH-M 2018; HDE-de, 06/18; Maßangaben unverbindlich. Konstruktionsänderungen vorbehalten.



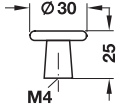

Oberfläche/Farbe	Artikel-Nr.
silberfarben eloxiert	133.74.903
schwarz eloxiert	134.82.615

Abpackung: 1 oder 10 Stück

1

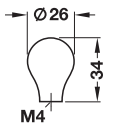
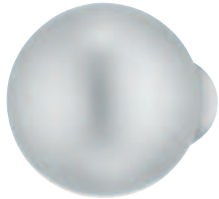

Oberfläche/Farbe	Artikel-Nr.
silberfarben eloxiert	135.16.900

Abpackung: 1 oder 25 Stück

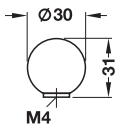

Oberfläche/Farbe	Artikel-Nr.
silberfarben matt eloxiert	135.15.900

Abpackung: 1 oder 25 Stück

Möbelknöpfe zeitlos

DGH-M 2018, HIDE-de, 06/18; Maßangaben unverbindlich. Konstruktionsänderungen vorbehalten.

Gewindeschrauben M4

► MB 1.470

15.04.2020  
ID 4941

1



Möbelknöpfe zeitlos

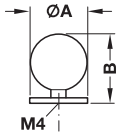
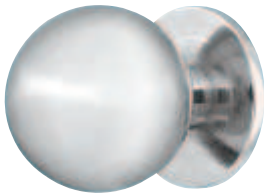

Oberfläche	Maß A mm	Maß B mm	Artikel-Nr.
verchromt poliert	25	31	134.97.202
vernickelt matt	25	31	134.97.602
poliert	25	31	134.97.802

Abpackung: 1 oder 25 Stück

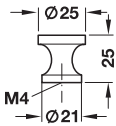

> Werkstoff: Messing

Oberfläche	Artikel-Nr.
verchromt poliert	136.76.205
vernickelt matt	136.76.607
poliert	136.76.803
gebürstet	136.76.810

Abpackung: 1 oder 25 Stück

passende Möbelgriffe zu 136.76.810 ▶ MB 1.166

passende Garderobenhaken zu 136.76.810 ▶ MB 1.437

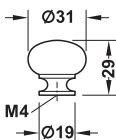

> Werkstoff: Messing

Oberfläche	Artikel-Nr.
vernickelt matt	155.01.540
vernickelt, schwarz	155.01.541
poliert	155.01.542
verchromt poliert	155.01.543

Abpackung: 1 oder 20 Stück

Gewindeschrauben M4 ▶ MB 1.470

DGH-M 2018; HDE-de, 06/18; Maßangaben unverbindlich. Konstruktionsänderungen vorbehalten.

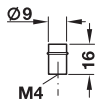
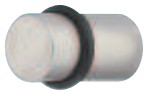

Oberfläche	Artikel-Nr.
Sockel: vernickelt matt Gummiring: schwarz	136.24.635

Abpackung: 1 oder 10 Stück

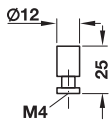

Oberfläche	Artikel-Nr.
verchromt poliert	137.38.200

Abpackung: 1 oder 25 Stück

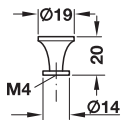
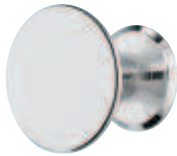

Oberfläche	Artikel-Nr.
verchromt poliert	136.27.202

Abpackung: 1 oder 25 Stück

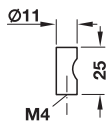

Oberfläche	Artikel-Nr.
verchromt poliert	136.06.212
verchromt matt	136.06.410
vernickelt matt	136.06.614
poliert	136.06.810

Abpackung: 1 oder 25 Stück

DGH-M 2018, HIDE-de, 06/18; Maßangaben unverbindlich. Konstruktionsänderungen vorbehalten.

Gewindeschrauben M4

► MB 1.470

1



Möbelknöpfe zeitlos

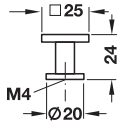

Oberfläche	Artikel-Nr.
verchromt poliert	137.80.200
edelstahlfarben	137.80.000
poliert	137.80.800

Abpackung: 1 oder 25 Stück

Gewindeschrauben M4

► MB 1.470

DGH-M 2018; HDE-de, 06/18; Maßangaben unverbindlich. Konstruktionsänderungen vorbehalten.

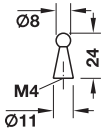
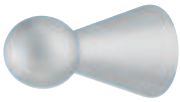

Oberfläche	Artikel-Nr.
verchromt matt	133.89.400

Abpackung: 1 oder 200 Stück

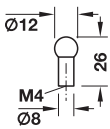
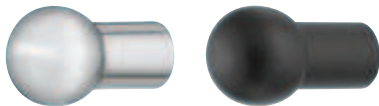

Oberfläche	Artikel-Nr.
verchromt poliert	136.09.204
schwarz matt	136.09.302

Abpackung: 1 oder 10 Stück

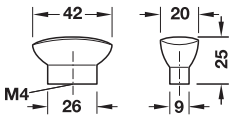
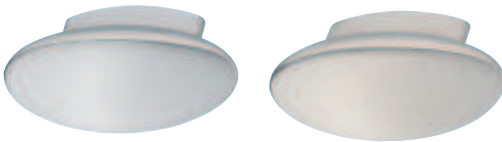

Oberfläche	Artikel-Nr.
verchromt matt	133.90.400
vernickelt matt	133.90.600

Abpackung: 1 oder 50 Stück

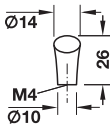

Oberfläche	Artikel-Nr.
verchromt poliert	155.00.580
verchromt matt	155.00.575
vernickelt matt	155.00.570

Abpackung: 1 oder 100 Stück

DGH-M 2018, HIDE-de, 06/18; Maßangaben unverbindlich. Konstruktionsänderungen vorbehalten.

Gewindeschrauben M4

► MB 1.470

1



Möbelknöpfe zeitlos

1



Möbelknöpfe zeitlos

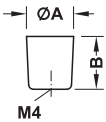
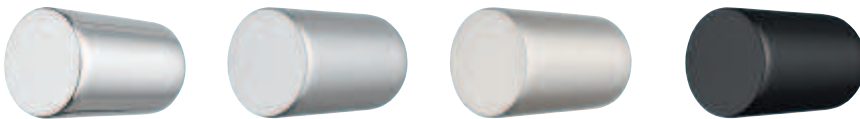

Oberfläche/Farbe	Maß A mm	Maß B mm	Artikel-Nr.
verchromt poliert	15	24	132.09.245
	25	28	132.09.240
verchromt matt	15	24	132.09.445
	25	28	132.09.440
vernickelt gebürstet	15	24	132.09.645
	25	28	132.09.640
schwarz matt	15	24	132.09.246
	25	28	132.09.241

Abpackung: 1 oder 25 Stück

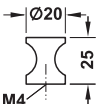

Oberfläche/Farbe	Artikel-Nr.
verchromt poliert	155.00.420
vernickelt matt	155.00.410
goldfarben, glänzend	155.00.415

Abpackung: 1 oder 25 Stück

Gewindeschrauben M4

► MB 1.470

DGH-M 2018; HDE-de, 06/18; Maßangaben unverbindlich. Konstruktionsänderungen vorbehalten.

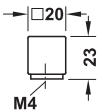

Oberfläche	Artikel-Nr.
verchromt poliert	133.28.210
verchromt matt	133.28.410
vernickelt matt gebürstet	133.28.610

Abpackung: 1 oder 25 Stück

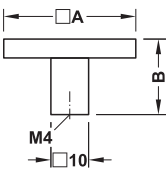

Oberfläche/ Farbe	Maß A mm	Maß B mm	Abpackung Stück	Artikel-Nr.
vernickelt	25	17	1 oder 30	155.00.590
gebürstet	35	20	1 oder 25	155.00.591
silberfarben	25	17	1 oder 30	155.00.585
	35	20	1 oder 25	155.00.586

DGH-M 2018, HIDE-de, 06/18; Maßangaben unverbindlich. Konstruktionsänderungen vorbehalten.

Gewindeschrauben M4

► MB 1.470



1



Möbelknöpfe zeitlos

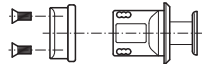
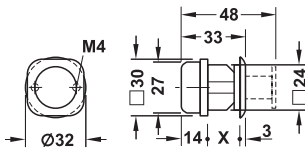

Holzdicke X = 17 – 21 mm

> Befestigungsmaterial im Lieferumfang enthalten

Oberfläche	Artikel-Nr.
aluminiumfarben	130.81.910

Abpackung: 1 oder 25 Stück

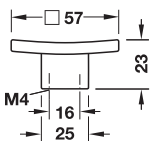

Oberfläche	Artikel-Nr.
verchromt poliert	131.11.200
verchromt matt	131.11.400
edelstahlfarben	131.11.000

Abpackung: 1 oder 10 Stück

Gewindeschrauben M4 ▶ MB 1.470

DGH-M 2018; HDE-de, 06/18; Maßangaben unverbindlich. Konstruktionsänderungen vorbehalten.

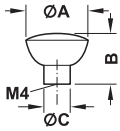

Oberfläche	Maß A mm	Maß B mm	Maß C mm	Artikel-Nr.
verchromt matt	33	27	14	135.48.403
edelstahlfarben	33	27	14	135.48.003
vernickelt matt	33	27	14	135.48.603

Abpackung: 1 oder 25 Stück

Passender Bogengriff ▶ MB 1.144

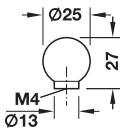

Oberfläche	Artikel-Nr.
verchromt poliert	136.08.207
vernickelt matt	136.08.609
goldfarben poliert	136.08.805

Abpackung: 1 oder 25 Stück

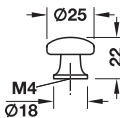

Oberfläche	Artikel-Nr.
verchromt poliert	134.39.202
vernickelt matt	134.39.604
goldfarben poliert	134.39.800

Abpackung: 1 oder 25 Stück

Gewindeschrauben M4 ▶ MB 1.470

DGH-M 2018, HIDE-de, 06/18; Maßangaben unverbindlich. Konstruktionsänderungen vorbehalten.

1

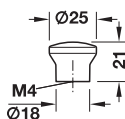

Oberfläche	Artikel-Nr.
verchromt matt	134.06.418

Abpackung: 1 oder 25 Stück

Möbelknöpfe zeitlos

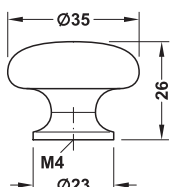

Oberfläche	Artikel-Nr.
vernickelt gebürstet	155.00.330

Abpackung: 1 oder 25 Stück

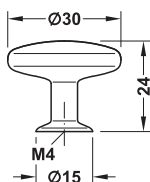

Oberfläche	Artikel-Nr.
vernickelt gebürstet	155.00.335

Abpackung: 1 oder 25 Stück

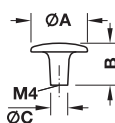

> Oberfläche: vernickelt matt

Maß A mm	Maß B mm	Maß C mm	Artikel-Nr.
37	26	12	134.23.624
30	23	10	134.23.615

Abpackung: 1 oder 25 Stück

Gewindeschrauben M4

► MB 1.470

DGH-M 2018; HDE-de, 06/18; Maßangaben unverbindlich. Konstruktionsänderungen vorbehalten.

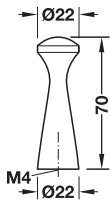

> Werkstoff: Buche

Oberfläche	Artikel-Nr.
natur	196.90.307

Abpackung: 1 oder 25 Stück

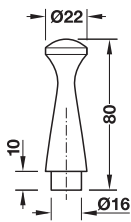

> Werkstoff: Buche

Oberfläche	Artikel-Nr.
natur	196.90.352

Abpackung: 1 oder 25 Stück

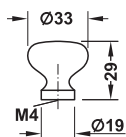

> Oberfläche: natur

Werkstoff	Artikel-Nr.
Eiche	196.74.401
Buche	196.74.303
Kiefer	196.74.009
Kirschbaum	196.74.607

Abpackung: 1 oder 25 Stück

Gewindeschrauben M4

► MB 1.470

1



Möbelknöpfe zeitlos

DGH-M 2018, HIDE-de, 06/18; Maßangaben unverbindlich. Konstruktionsänderungen vorbehalten.

1

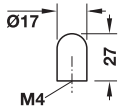

> Werkstoff: Gummi

Farbe	Artikel-Nr.
schwarz	138.82.301

Abpackung: 1 oder 50 Stück

Gewindeschrauben M4 ▶ MB 1.470



Möbelknöpfe zeitlos

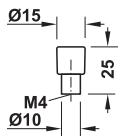

> Werkstoff: Kunststoff

Farbe	Artikel-Nr.
schwarz	138.44.305

Abpackung: 1 oder 100 Stück

Gewindeschrauben M4 ▶ MB 1.470

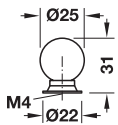

> Werkstoff: Knopf: Gummi,  
Sockel: Messing

Farbe	Artikel-Nr.
Knopf: schwarz Sockel: silberfarben	139.20.310

Abpackung: 1 oder 50 Stück

Gewindeschrauben M4 ▶ MB 1.470

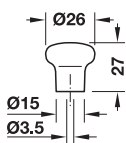

Farbe	Artikel-Nr.
weiß	136.86.000

Abpackung: 1 oder 100 Stück

Spanplattenschrauben Senkkopf Hospa Ø 4 mm ▶ MB 1.470

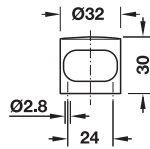

Werkstoff	verfügbare Farben ab Lager	Artikel-Nr.
Polyamid	90, 99	139.00.4**

Abpackung: 1 Stück

Spanplattenschrauben Panhead Hospa Ø 3,5 mm ▶ MB 1.470

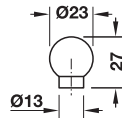

Werkstoff	verfügbare Farben ab Lager	Artikel-Nr.
Polyamid	33, 50, 90, 92, 97, 99	139.11.1**

Abpackung: 1 oder 25 Stück

Spanplattenschrauben Panhead Hospa Ø 3,5 mm ▶ MB 1.470

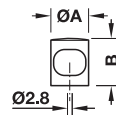

Diese Knöpfe sind sowohl von der Vorderseite als auch von der Rückseite zu befestigen.  
Schraube wird mit Abdeckkappe verdeckt.



> Werkstoff: Polyamid

Maß A mm	Maß B mm	verfügbare Farben ab Lager	Artikel-Nr.
13	25	33, 90, 99	139.00.1**
20	28	90, 99	139.00.2**
23	29	33, 90, 99	139.00.3**

Abpackung: 1 Stück

**Bestellhinweis**

Bei Bestellung ersetzen Sie bitte die \*\* durch die Farb-Nummer Ihrer Wahl.

Befestigung von der Vorderseite: ▶ MB 1.470  
Spanplattenschrauben Panhead Hospa Ø 3,0 mm

Befestigung von der Rückseite: ▶ MB 1.470  
Spanplattenschrauben Panhead Hospa Ø 3,5 mm



1

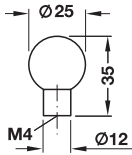

> Werkstoff: Knopf: Glas,  
Sockel: Edelstahl, Güte 1.4305

Oberfläche	Artikel-Nr.
Knopf: matt fluoreszierend	133.50.540

Abpackung: 1 Stück



Möbelknöpfe zeitlos



> Werkstoff: Knopf: Glas,  
Sockel: Messing

Oberfläche	Maß A mm	Maß B mm	Maß C mm	Artikel-Nr.
Knopf: klar	25	33	20	132.03.421
Sockel: verchromt poliert	30	43	26	132.03.422
Knopf: klar	25	33	20	132.03.481
Sockel: poliert	30	43	26	132.03.482

Abpackung: 1 oder 10 Stück

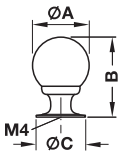

> Werkstoff: Knopf: Glas,  
Sockel: Edelstahl, Güte 1.4305

Oberfläche	Artikel-Nr.
Knopf: matt	133.50.530
Knopf: klar	133.50.430

Abpackung: 1 Stück

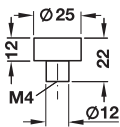

passender Möbelgriff ▶ MB 1.223

Gewindeschrauben M4 ▶ MB 1.470

DGH-M 2018; HDE-de, 06/18; Maßangaben unverbindlich. Konstruktionsänderungen vorbehalten.



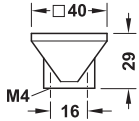

> Werkstoff: Knopf: Zinkdruckguss,  
Einlage: Glas

Oberfläche	Artikel-Nr.
Knopf: verchromt poliert Einlage: weiß	131.14.271

Abpackung: 1 oder 25 Stück

Möbelknöpfe zeitlos

passender Möbelgriff	► MB 1.189
Gewindeschrauben M4	► MB 1.470

1

- > unsichtbares, komplett in die Front integriertes Griffsystem
- > horizontal oder vertikal zu montieren
- > Griff über gesamte Länge der Tür oder des Schubkastens
- > weiches Öffnen und Schließen durch gedämpfte Scharniere



Griff-Profileleisten zeitlos

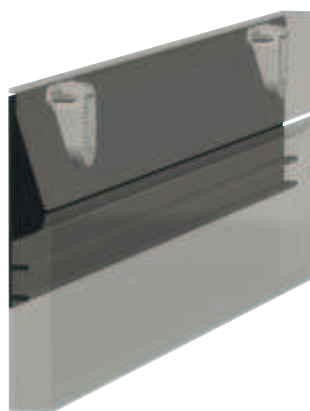
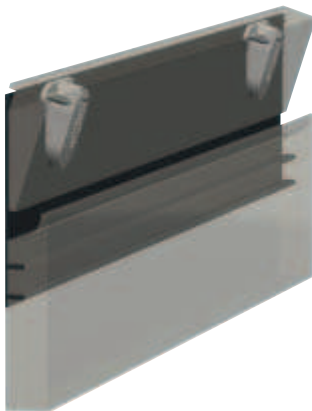

- > Werkstoff: Schiene: Aluminium, Scharniere: Kunststoff
- > Länge: Schiene: 3000 mm, individuell kürzbar
- > Breite: Frontbreite Tür:  $\geq 200$  mm, Frontbreite Schubkasten:  $\geq 250$  mm
- > Höhe: Fronthöhe Tür:  $\geq 250$  mm, Fronthöhe Schubkasten:  $\geq 200$  mm
- > Materialdicke:  $\geq 22$  mm

#### Lieferumfang

Komplett-Set:  
1 Schiene  
6 Scharniere  
Befestigungsmaterial

	Artikel-Nr.
Komplett-Set	126.30.000
einzelnes Scharnier	126.30.010

Abpackung: 1 oder 10 Stück

DGH-M 2018; HDE-de, 06/18; Maßangaben unverbindlich. Konstruktionsänderungen vorbehalten.

### Planung: Griff-Profilleiste

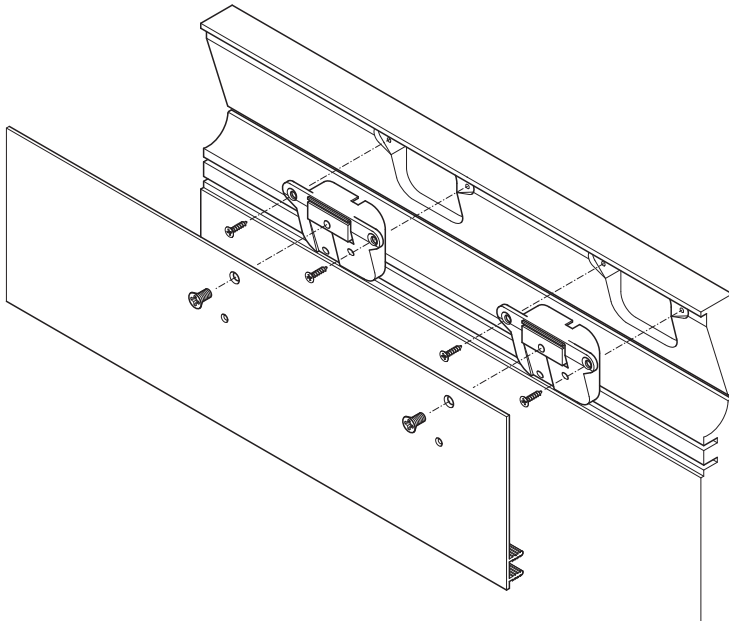

### Anwendungsbeispiele

Türdicke = 22 mm

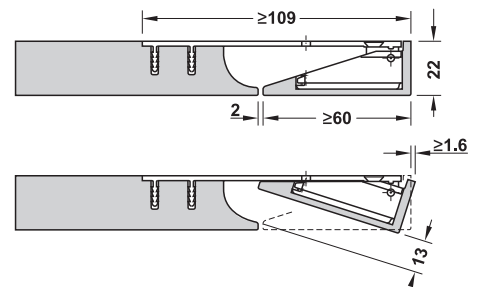

Türdicke = 25 mm

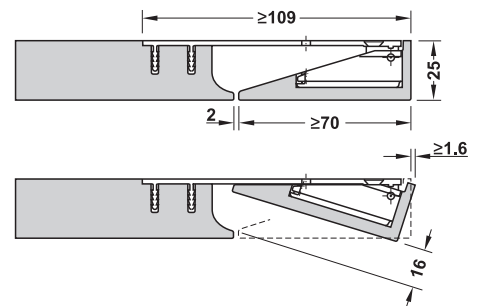

### Bearbeitung: Platte zum Einlassen des Scharniers

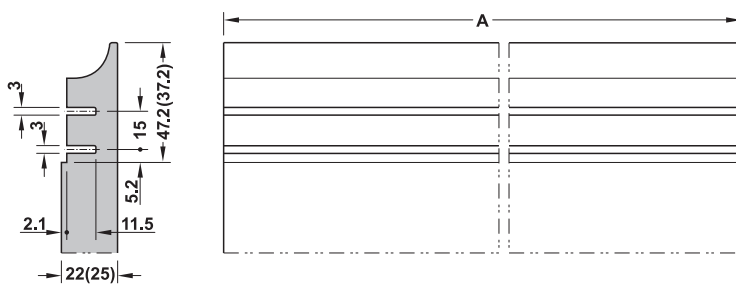
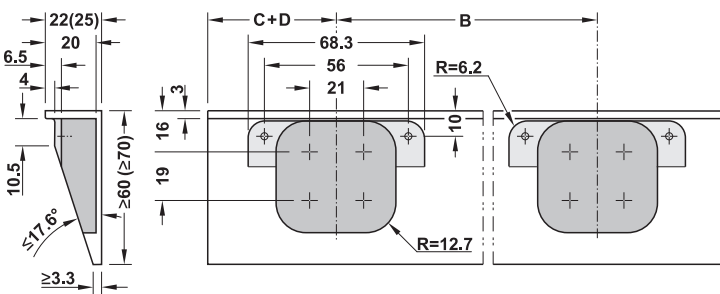

Türdicke + Glasdicke = 20 + 4 + 1 mm

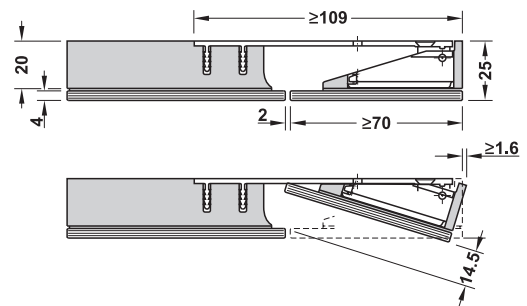

A mm	B mm	C mm		Anzahl Schar- niere
		für D = 0 mm	für D = 2 mm	
150-349	50-249	50	48	2
350-599	250	50-174,5	48-172,5	2
600-1099	500	50-299,5	48-297,5	2
1100-1599	500	50-299,5	48-297,5	3
1600-2099	500	50-299,5	48-297,5	4
2100-2599	500	50-299,5	48-297,5	5
2600-3000	500	50-250	48-248	6

### Schiene

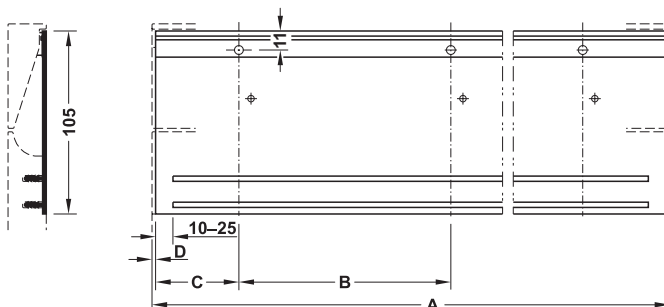

- A Gesamtlänge der Front
- B Abstand zwischen Scharnieren
- C Abstand erste Lochbohrung
- D Überstand der Front über Schiene

1



Griff-Profilleisten zeitlos



Montage

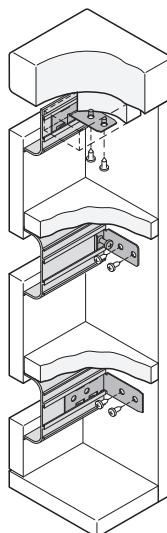

### Griff-Mulde

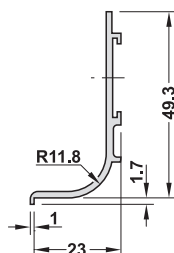
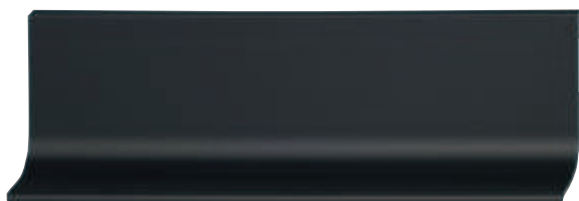

> Einsatzbereich: für grifflose Fronten, zur Montage zwischen Arbeitsplatte und darunter liegender Front

Oberfläche	Länge:	Länge:
	2500 mm	5000 mm
	Nutzlänge:	Nutzlänge:
	2460 mm	4950 mm
silberfarben eloxiert (E6/EV1)	126.37.900	126.37.905
edelstahlfarben eloxiert (E6)	126.37.001	126.37.006
weiß, RAL 9010, pulverbeschichtet	126.37.700	126.37.705
schwarz matt eloxiert (E6/C35)	123.37.301	123.37.306

Abpackung: 1 Stück

Beleuchtung

► MB 2.69

DGH-M 2018; HDE-de, 06/18; Maßangaben unverbindlich. Konstruktionsänderungen vorbehalten.

Zubehör

→ Außenecke



> Werkstoff: Kunststoff

Oberfläche	Artikel-Nr.
silberfarben	126.37.985
edelstahlfarben	126.37.075
weiß, RAL 9010	126.37.775
schwarz, RAL 9005	126.37.375

Abpackung: 1 oder 50 Stück

→ Innenecke



> Werkstoff: Kunststoff

Oberfläche	Artikel-Nr.
silberfarben	126.37.980
edelstahlfarben	126.37.074
weiß, RAL 9010	126.37.774
schwarz, RAL 9005	126.37.374

Abpackung: 1 oder 50 Stück

→ Endkappe



> Werkstoff: Kunststoff

Oberfläche	Anschlag	Artikel-Nr.
silberfarben	rechts	126.37.997
	links	126.37.998
edelstahlfarben	rechts	126.37.097
	links	126.37.098
weiß, RAL 9010	rechts	126.37.977
	links	126.37.978
schwarz, RAL 9005	rechts	126.37.937
	links	126.37.938

Abpackung: 1 oder 50 Stück

1

Griff-Mulde

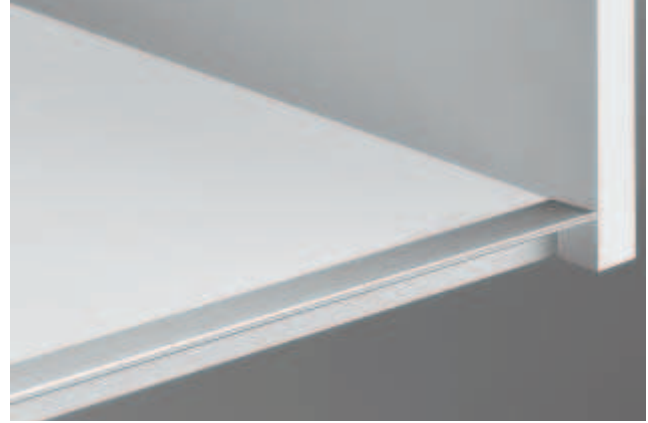

Griff-Profilleisten zeitlos

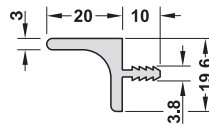
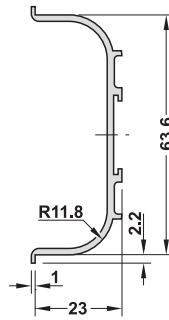

> Einsatzbereich: für grifflose Fronten,  
zur Montage zwischen den Fronten

Oberfläche/Farbe	Länge: 2500 mm Nutzlänge: 2460 mm	Länge: 5000 mm Nutzlänge: 4950 mm
silberfarben eloxiert (E6/EV1)	126.36.900	126.36.905
edelstahlfarben eloxiert (E6)	126.36.001	126.36.006
weiß, RAL 9010, pulverbeschichtet	126.36.700	126.36.705
schwarz matt eloxiert (E6/C35)	126.36.310	126.36.306

Abpackung: 1 Stück

> Einsatzbereich: für grifflose Fronten,  
zur Montage am Unterboden  
des Oberschranks

> Länge: 2500 mm  
> Nutzlänge: 2450 mm

Oberfläche/Farbe	Artikel-Nr.
silberfarben eloxiert (E6/EV1)	126.53.902
edelstahlfarben eloxiert (E6)	126.53.003
weiß, RAL 9010, pulverbeschichtet	126.53.702
schwarz matt eloxiert (E6/C35)	126.53.303

Abpackung: 1 Stück

DGH-M 2018; HDE-de, 06/18; Maßangaben unverbindlich. Konstruktionsänderungen vorbehalten.

Zubehör

→ Außenecke



> Werkstoff: Kunststoff

Oberfläche	Artikel-Nr.
silberfarben	126.37.986
edelstahlfarben	126.37.071
weiß, RAL 9010	126.37.771
schwarz, RAL 9005	126.37.371

Abpackung: 1 oder 50 Stück

→ Innenecke



> Werkstoff: Kunststoff

Oberfläche	Artikel-Nr.
silberfarben	126.37.981
edelstahlfarben	126.37.070
weiß, RAL 9010	126.37.770
schwarz, RAL 9005	126.37.370

Abpackung: 1 oder 50 Stück

→ Endkappe



> Werkstoff: Kunststoff

Oberfläche/Farbe	Artikel-Nr.
silberfarben	126.37.996
edelstahlfarben	126.37.096
weiß, RAL 9010	126.37.976
schwarz, RAL 9005	126.37.936

Abpackung: 1 oder 50 Stück

→ Befestigungswinkel 90°

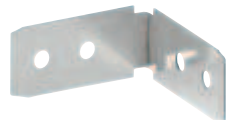

Werkstoff	Artikel-Nr.
Edelstahl	126.37.990

Abpackung: 1 oder 100 Stück

→ Befestigungswinkel

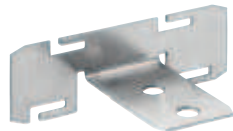

Werkstoff	Artikel-Nr.
Edelstahl	126.37.988

Abpackung: 1 oder 100 Stück

→ Befestigungslasche



> Oberfläche: verzinkt

Werkstoff	Artikel-Nr.
Stahl	126.37.989

Abpackung: 1 oder 100 Stück

Spanplattenschrauben Hospa Senkkopf Ø 4 mm ▶ MB 1.470

DGH-M 2018, HDE-de, 06/18; Maßangaben unverbindlich. Konstruktionsänderungen vorbehalten.

1  
GAEB  
CAD  
Griff-Profileleisten zeitlos



1



Griff-Profileleisten zeitlos



Montage

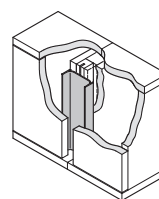

Profil vor den  
Seitenwänden

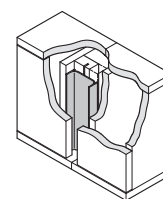

Profil zwischen den  
Seitenwänden

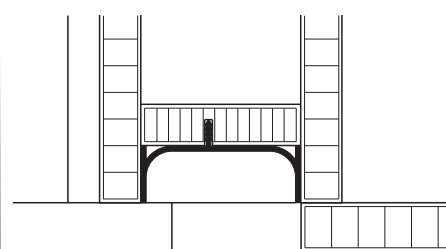

Montage Beispiel

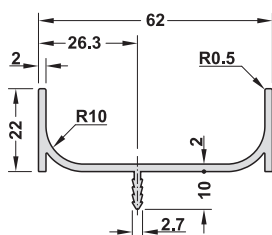

- > Einsatzbereich: für grifflose Fronten, zur vertikalen Montage vor und zwischen Hochschrank-Seitenwänden
- > Länge: 2500 mm
- > Nutzlänge: 2460 mm

Oberfläche/Farbe	Artikel-Nr.
silberfarben eloxiert (E6/EV1)	126.37.912
edelstahlfarben eloxiert (E6)	126.37.113
weiss, RAL 9010, pulverbeschichtet	126.37.712
schwarz matt eloxiert (E6/C35)	126.37.313

Abpackung: 1 Stück

passendes Füllprofil

▶ MB 1.295

DGH-M 2018; HDE-de, 06/18; Maßangaben unverbindlich. Konstruktionsänderungen vorbehalten.

Griff-Mulde, vertikal



- > Einsatzbereich: für grifflose Fronten, zur vertikalen Montage an die Hochschrank-Seitenwand
- > Länge: 2500 mm
- > Nutzlänge: 2460 mm

Oberfläche/Farbe	Artikel-Nr.
silberfarben eloxiert (E6/EV1)	126.37.922
edelstahlfarben eloxiert (E6)	126.37.123
weiß, RAL 9010, pulverbeschichtet	126.37.722
schwarz matt eloxiert (E6/C35)	126.37.323

Abpackung: 1 Stück

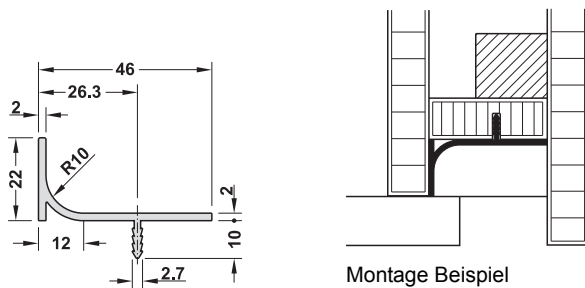

→ Füllprofil



- > Einsatzbereich: für Elektro-Geräte

Länge mm	Oberfläche/Farbe	Artikel-Nr.
600	silberfarben eloxiert (E6/EV1)	126.37.932
	edelstahlfarben eloxiert (E6)	126.37.140
	weiß, RAL 9010, pulverbeschichtet	126.37.730
	schwarz matt eloxiert (E6/C35)	126.37.340
1150	silberfarben eloxiert (E6/EV1)	126.37.931
	edelstahlfarben eloxiert (E6)	126.37.141
	weiß, RAL 9010, pulverbeschichtet	126.37.731
	schwarz matt eloxiert (E6/C35)	126.37.341

Abpackung: 1 Stück

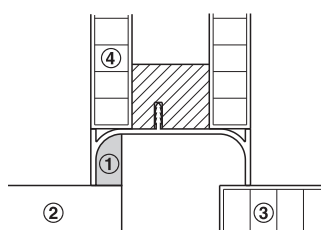

- ① Füllprofil
- ② Elektrogerät
- ③ Front
- ④ Seitenwand

DGH-M 2018, HDE-de, 06/18; Maßangaben unverbindlich. Konstruktionsänderungen vorbehalten.

1  
GAEB  
CAD  
Griff-Profileleisten zeitlos

Griff-Mulde

1



Griff-Profileleisten zeitlos

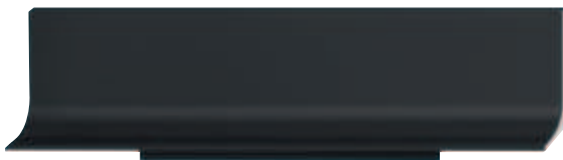

> Einsatzbereich: für grifflose Spülmaschinen-Fronten  
> Länge: 595 mm,  
Harpunensteg: 525 mm

Oberfläche/Farbe	Artikel-Nr.
silberfarben eloxiert (E6/EV1)	126.37.950
edelstahlfarben eloxiert (E6)	126.37.660
weiß, RAL 9010, pulverbeschichtet	126.37.750
schwarz matt eloxiert (E6/C35)	126.37.351

Abpackung: 1 Stück

**Hinweis**

Bitte berücksichtigen Sie die notwendige Aufdopplung der Front bei der Küchenplanung.

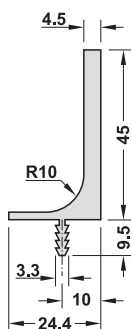

DGH-M 2018; HDE-de, 06/18; Maßangaben unverbindlich. Konstruktionsänderungen vorbehalten.

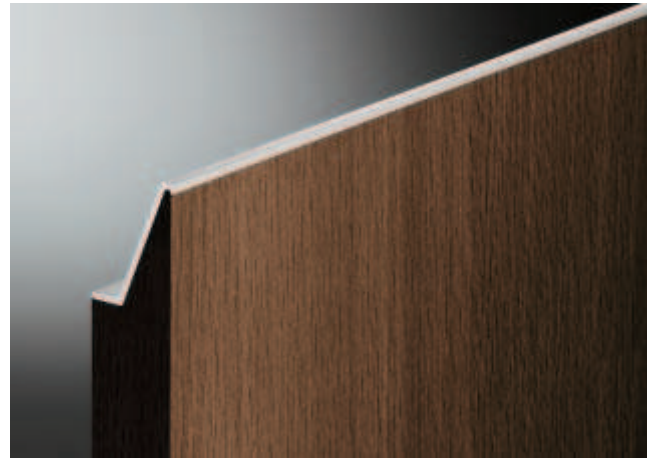

Mit diesen Griff-Profilleisten lassen sich optisch grifflose Möbelfronten gestalten.



- > Länge: 2500 mm
- > Nutzlänge: 2450 mm

Oberfläche	Artikel-Nr.
silberfarben eloxiert (E6/EV1)	126.35.945
edelstahlfarben eloxiert (E6)	126.35.045

Abpackung: 1 Stück

**Hinweis**

Retuschierstift edelstahlfarben zur Nachbearbeitung der Schnittkanten kann unter 007.33.060 bestellt werden.

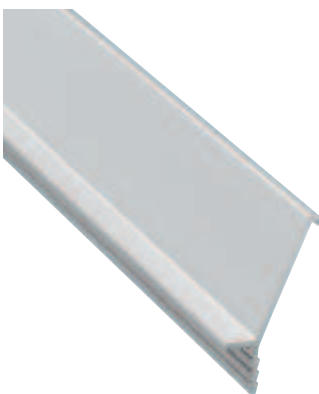
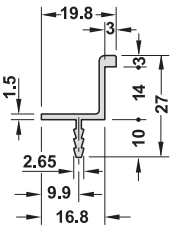

- > Länge: 2500 mm
- > Nutzlänge: 2450 mm

Oberfläche	Artikel-Nr.
silberfarben eloxiert (E6/EV1)	126.35.935

Abpackung: 1 Stück

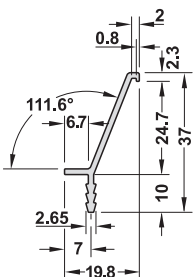

DGH-M 2018, HIDE-de, 06/18; Maßangaben unverbindlich. Konstruktionsänderungen vorbehalten.

1



Griff-Profileleisten zeitlos

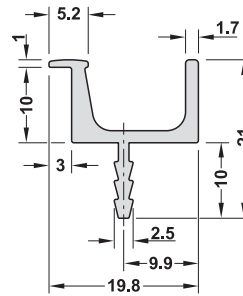

- > Länge: 2500 mm
- > Nutzlänge: 2450 mm

Oberfläche	Artikel-Nr.
silberfarben eloxiert (E6/EV1)	126.95.900
edelstahlfarben eloxiert (E6)	126.95.000

Abpackung: 1 Stück

**Hinweis**

Retuschierstift edelstahlfarben zur Nachbearbeitung der Schnittkanten kann unter 007.33.060 bestellt werden.

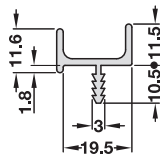

- > Oberfläche: silberfarben eloxiert (E6/EV1)

Länge mm	Artikel-Nr.
2500	126.20.905

Abpackung: 1 Stück

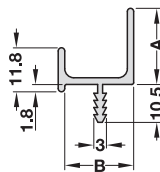

- > Oberfläche: silberfarben eloxiert (E6/EV1)

Maß A mm	Maß B mm	Länge mm	Artikel-Nr.
21	19,5	2500	126.21.902
30	19,5	2500	126.22.909

Abpackung: 1 Stück

**Hinweis**

Retuschierstift 007.33.062 zum Kaschieren der Schnittflächen ist speziell auf silberfarbene Aluprofile abgestimmt.

DGH-M 2018; HDE-de, 06/18; Maßangaben unverbindlich. Konstruktionsänderungen vorbehalten.

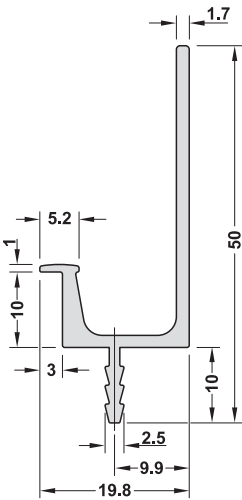
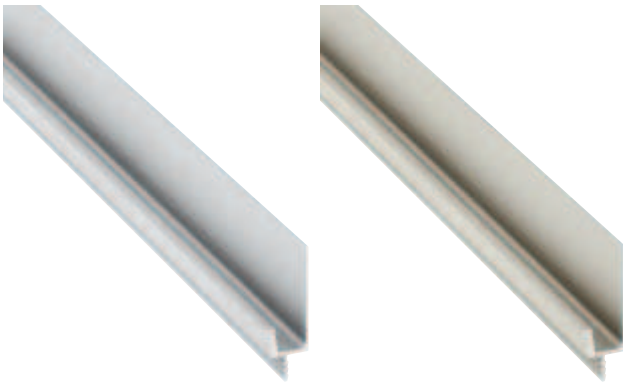

- > Länge: 2500 mm
- > Nutzlänge: 2450 mm

Oberfläche	Artikel-Nr.
silberfarben eloxiert (E6/EV1)	126.95.910
edelstahlfarben eloxiert (E6)	126.95.010

Abpackung: 1 Stück

**Hinweis**

Retuschierstift edelstahlfarben zur Nachbearbeitung der Schnittkanten kann unter 007.33.060 bestellt werden.



1



Griff-Profilleisten zeitlos

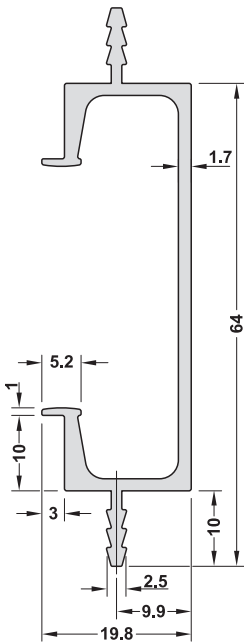
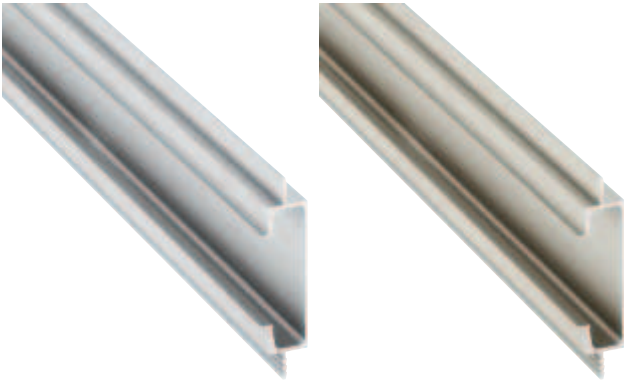

- > Länge: 2500 mm
- > Nutzlänge: 2450 mm

Oberfläche	Artikel-Nr.
silberfarben eloxiert (E6/EV1)	126.95.920
edelstahlfarben eloxiert (E6)	126.95.020

Abpackung: 1 Stück

**Hinweis**

Retuschierstift edelstahlfarben zur Nachbearbeitung der Schnittkanten kann unter 007.33.060 bestellt werden.

DGH-M 2018; HDE-de, 06/18; Maßangaben unverbindlich. Konstruktionsänderungen vorbehalten.



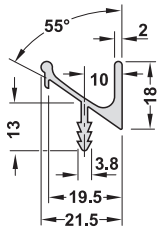
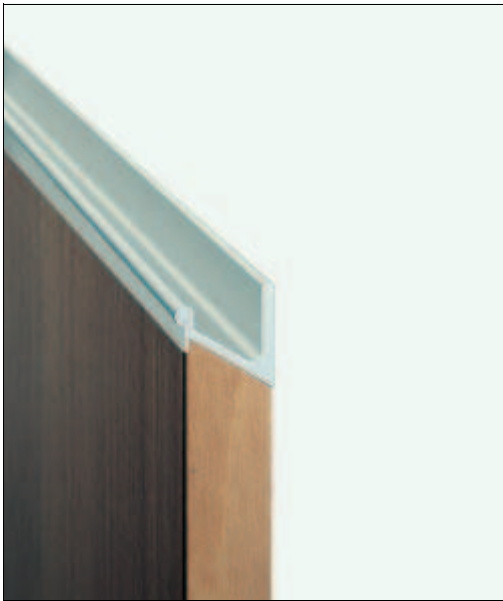

> Oberfläche: silberfarben eloxiert (E6/EV1)

Länge mm	Nutzlänge mm	Artikel-Nr.
2500	2400	126.38.925

Abpackung: 1 Stück

**Hinweis**

Retuschierstift 007.33.062 zum Kaschieren der Schnittflächen ist speziell auf silberfarbene Aluprofile abgestimmt.

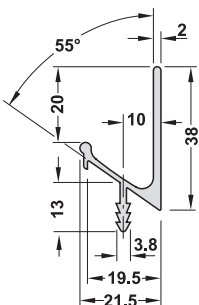
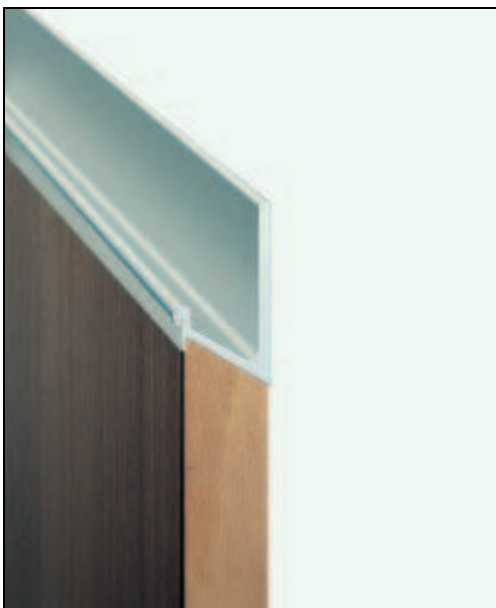

> Oberfläche: silberfarben eloxiert (E6/EV1)

Länge mm	Nutzlänge mm	Artikel-Nr.
2500	2400	126.35.925

Abpackung: 1 Stück

**Hinweis**

Retuschierstift 007.33.062 zum Kaschieren der Schnittflächen ist speziell auf silberfarbene Aluprofile abgestimmt.

DGH-M 2018, HIDE-de, 06/18; Maßangaben unverbindlich. Konstruktionsänderungen vorbehalten.

1  
GAEB  
CAD  
Griff-Profilleisten zeitlos

1



Griff-Profilleisten zeitlos

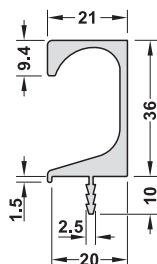
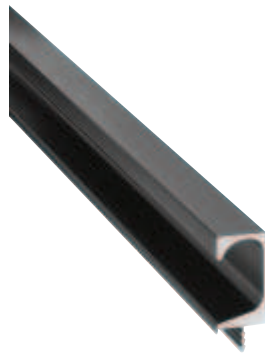
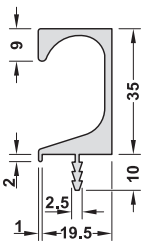
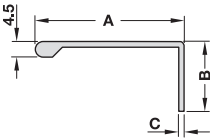
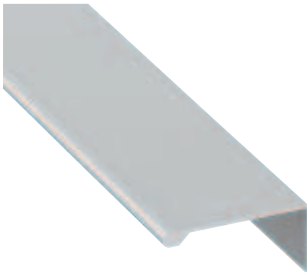
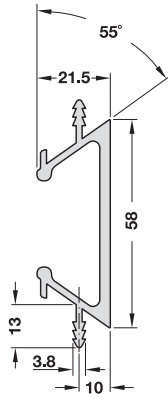
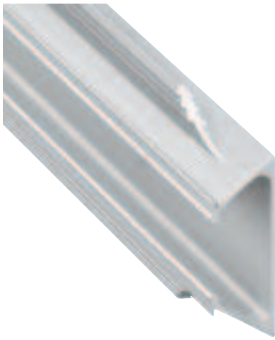

> Oberfläche: silberfarben eloxiert (E6/EV1)

Länge mm	Artikel-Nr.
2500	126.13.900

Abpackung: 1 Stück

**Hinweis**

Retuschierstift zum Kaschieren der Schnittflächen ist speziell auf die Aluprofile abgestimmt:  
silberfarben 007.33.062

> Einsatzbereich: Artikel 126.19.900 und 155.01.631 geeignet für 40 mm dicke Schiebetüren

Oberfläche	Länge mm	Maß A mm	Maß B mm	Maß C mm	Artikel-Nr.
silberfarben eloxiert (E6/EV1)	2500	43	20	1.6	126.14.901
	3000	63	40	2.2	126.19.900
edelstahlfarben	2500	43	20	1.6	155.01.630
	2500	63	40	2.2	155.01.631

Abpackung: 1 Stück

**Hinweis**

Retuschierstift zum Kaschieren der Schnittflächen ist speziell auf die Aluprofile abgestimmt:  
silberfarben 007.33.062  
edelstahlfarben 007.33.060

Länge mm	Oberfläche	Artikel-Nr.
2500	edelstahlfarben	155.01.632
	schwarz	155.01.633

Abpackung: 1 Stück

**Hinweis**

Retuschierstift zum Kaschieren der Schnittflächen ist speziell auf die Aluprofile abgestimmt:  
edelstahlfarben 007.33.060  
schwarz 007.33.061

Länge mm	Oberfläche	Artikel-Nr.
2500	silberfarben eloxiert (E6/EV1)	155.01.150

Abpackung: 1 Stück

**Hinweis**

Retuschierstift zum Kaschieren der Schnittflächen ist speziell auf die Aluprofile abgestimmt:  
silberfarben 007.33.062

DGH-M 2018; HDE-de, 06/18; Maßangaben unverbindlich. Konstruktionsänderungen vorbehalten.

Griff-Profileiste – Topco

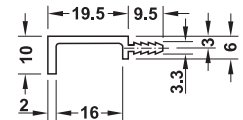

Griff-Ausräsung Form G

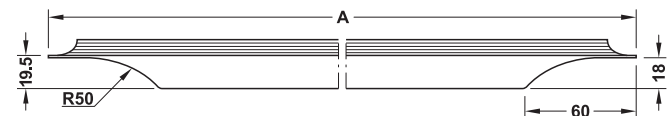

Griff-Ausräsung Form H



Griff-Ausräsung Form M

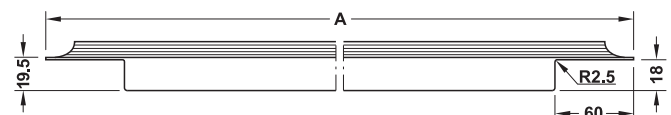

Oberflächen



silberfarben



edelstahl



schwarz matt

Fräsung Harpunensteg

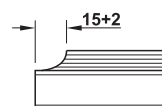

Länge mm	Artikel-Nr.
Fixlänge mit Griff-Ausräsung G = 160–2.500	126.28.070
Fixlänge mit Griff-Ausräsung H = 226–2.500	
Fixlänge mit Griff-Ausräsung M = 160–2.500	

Abpackung: 1 Stück

**topCo** KUNDENINDIVIDUELL  
BEREITS AB EINEM STÜCK

- Folgende Eigenschaften können Sie wählen:
- > Gesamtlänge (Maß A)
  - > Griff-Ausräsung (G, H oder M)
  - > Oberfläche

Griff-Profileisten zeitlos

DGH-M 2018, HIDE-de, 06/18; Maßangaben unverbindlich. Konstruktionsänderungen vorbehalten.

1



Griff-Profileleisten zeitlos

Griff-Profileiste – Topco

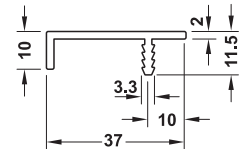

Griff-Ausfräsung Form G

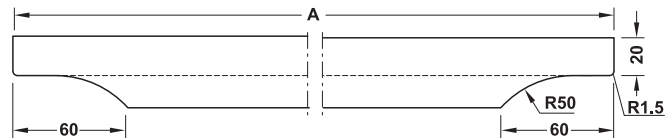

Griff-Ausfräsung Form H

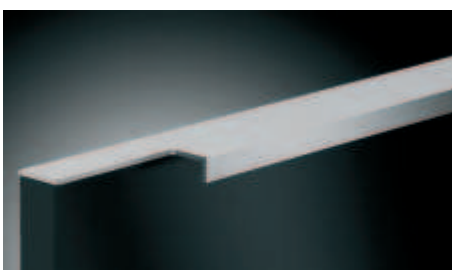
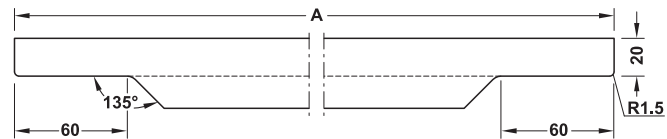

Griff-Ausfräsung Form M

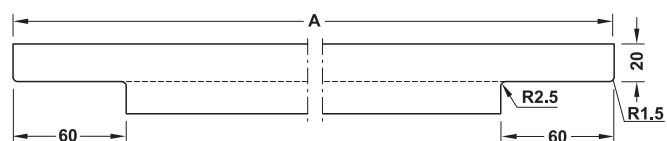

Oberflächen



silberfarben



edelstahl



schwarz matt

Hinweis

Diese Profile werden nach der Bearbeitung einzeln eloxiert. Dadurch entsteht eine einheitliche, qualitativ hochwertige Oberfläche.

Fräsung Harpunensteg

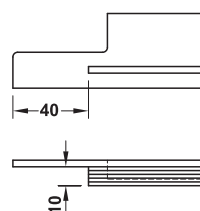

Länge mm	Artikel-Nr.
Fixlänge mit Griffausfräsung: 200 bis 2.500 mm	126.28.019
Fixlänge ohne Griffausfräsung: 50 bis 3.500 mm	

Abpackung: 1 Stück

topCo KUNDENINDIVIDUELL  
BEREITS AB EINEM STÜCK

Folgende Eigenschaften können Sie wählen:

- > Gesamtlänge (Maß A)
- > Griff-Ausfräsung (G, H oder M)
- > Oberfläche

DGH-M 2018; HDE-de, 06/18; Maßangaben unverbindlich. Konstruktionsänderungen vorbehalten.

Griff-Profileiste – Topco

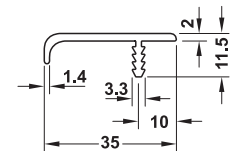
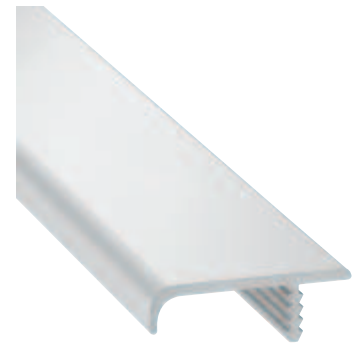

Griff-Ausfräsung Form G

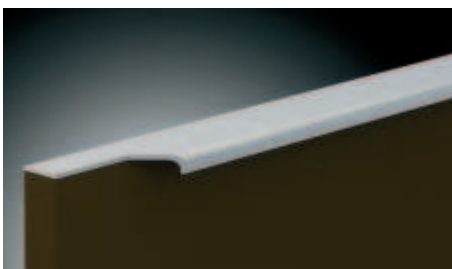
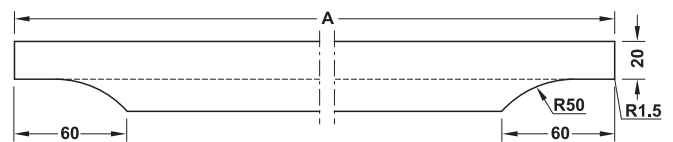

Griff-Ausfräsung Form H

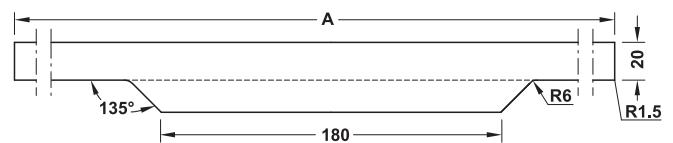

Griff-Ausfräsung Form M

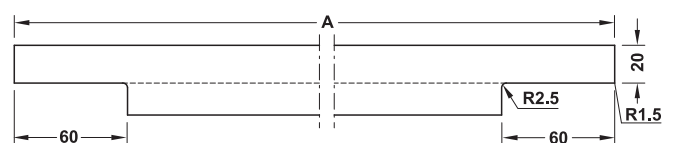

Oberflächen



silberfarben edelstahl schwarz matt

Hinweis

Diese Profile werden nach der Bearbeitung einzeln eloxiert. Dadurch entsteht eine einheitliche, qualitativ hochwertige Oberfläche.

Fräsung Harpunensteg

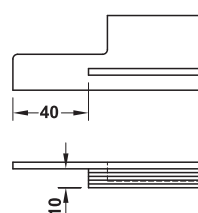

Länge mm	Artikel-Nr.
Fixlänge mit Griffausfräsung: 250 bis 1.200 mm	126.28.049
Fixlänge ohne Griffausfräsung: 50 bis 3.500 mm	

Abpackung: 1 Stück

**topCo** KUNDENINDIVIDUELL  
BEREITS AB EINEM STÜCK

Folgende Eigenschaften können Sie wählen:

- > Gesamtlänge (Maß A)
- > Griff-Ausfräsung (G, H oder M)
- > Oberfläche



Griff-Profileiste – Topco

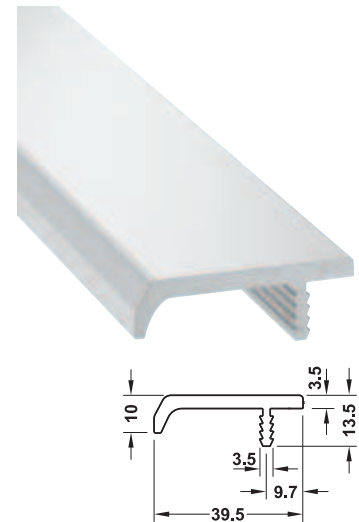

Griff-Profileisten zeitlos



Griff-Ausfräsung Form A

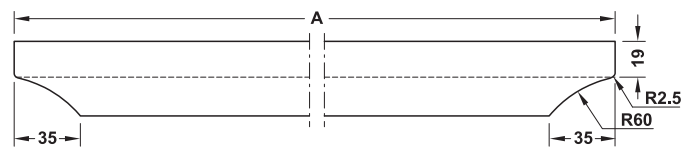

Griff-Ausfräsung Form B

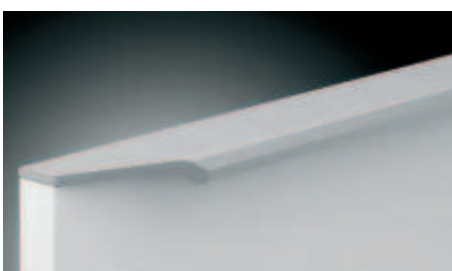
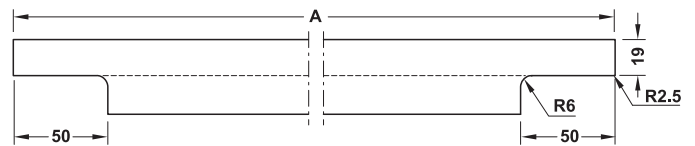

Griff-Ausfräsung Form C

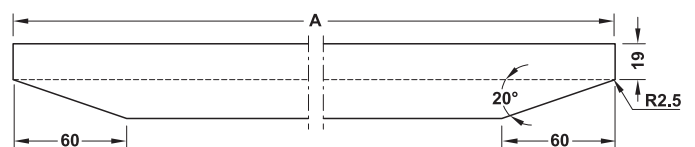

Oberflächen



silberfarben



edelstahl



schwarz matt

Hinweis

Diese Profile werden nach der Bearbeitung einzeln eloxiert. Dadurch entsteht eine einheitliche, qualitativ hochwertige Oberfläche.

Fräsung Harpunensteg

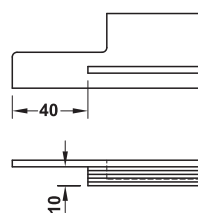

Länge mm	Artikel-Nr.
Fixlänge mit Griffausfräsung: 200 bis 1.200 mm	126.28.009
Fixlänge ohne Griffausfräsung: 50 bis 3.500 mm	

Abpackung: 1 Stück

**topCo** KUNDENINDIVIDUELL  
BEREITS AB EINEM STÜCK

Folgende Eigenschaften können Sie wählen:

- > Gesamtlänge (Maß A)
- > Griff-Ausfräsung (A, B oder C)
- > Oberfläche

DGH-M 2018; HDE-de, 06/18; Maßangaben unverbindlich. Konstruktionsänderungen vorbehalten.

Griff-Profileiste – Topco

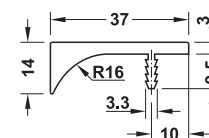
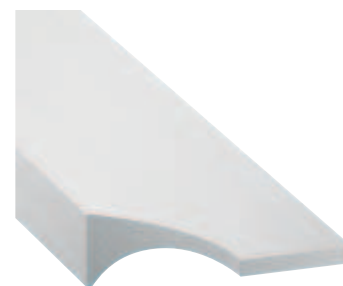

Griff-Ausfräsung Form O

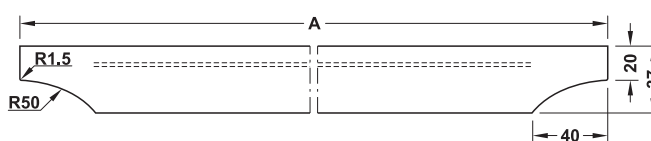

Griff-Ausfräsung Form P

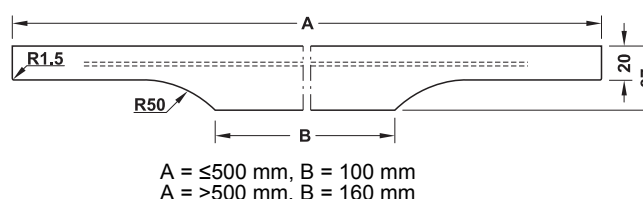

Griff-Ausfräsung Form R

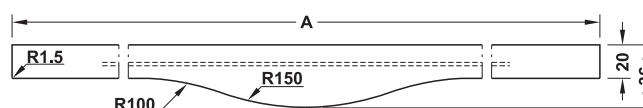

Oberflächen



silberfarben edelstahl schwarz matt

Fräsung Harpunensteg

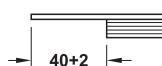

Länge mm	Artikel-Nr.
Fixlänge mit Griff-Ausfräsung O = 120–2.500	126.28.060
Fixlänge mit Griff-Ausfräsung P = 220–2.500	
Fixlänge mit Griff-Ausfräsung R = 180–2.500	

Abpackung: 1 Stück

topCo KUNDENINDIVIDUELL  
BEREITS AB EINEM STÜCK

Folgende Eigenschaften können Sie wählen:

- > Gesamtlänge (Maß A)
- > Griff-Ausfräsung (O, P oder R)
- > Oberfläche

DGH-M 2018, HDE-de, 06/18; Maßangaben unverbindlich. Konstruktionsänderungen vorbehalten.

Griff-Profileisten zeitlos



1



Griff-Profilleisten zeitlos

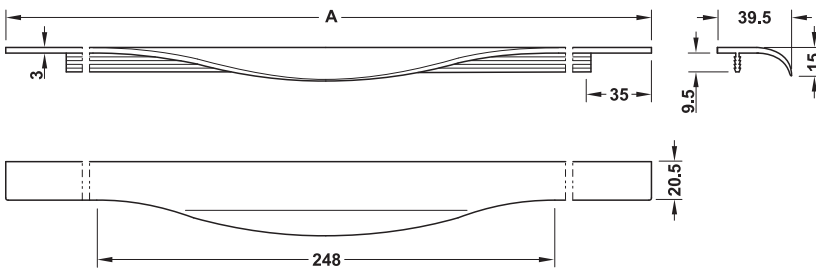

- > Werkstoff: Aluminium
- > Oberfläche: edelstahlfarben

Korpusbreite mm	Maß A mm	Artikel-Nr.
400	395	126.61.002
500	495	126.61.004
600	595	126.61.005
800	795	126.61.006
900	895	126.61.007

Abpackung: 1 Stück

DGH-M 2018; HDE-de, 06/18; Maßangaben unverbindlich. Konstruktionsänderungen vorbehalten.

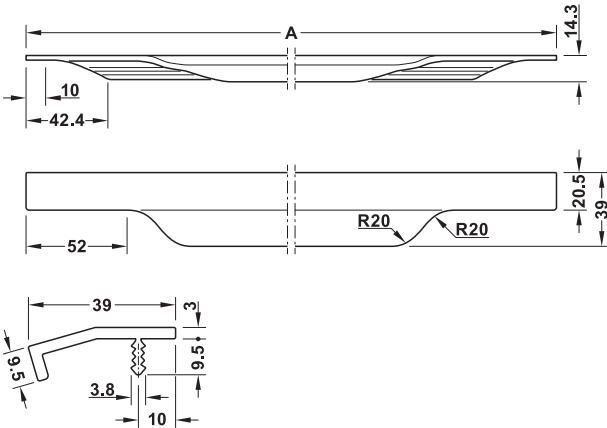
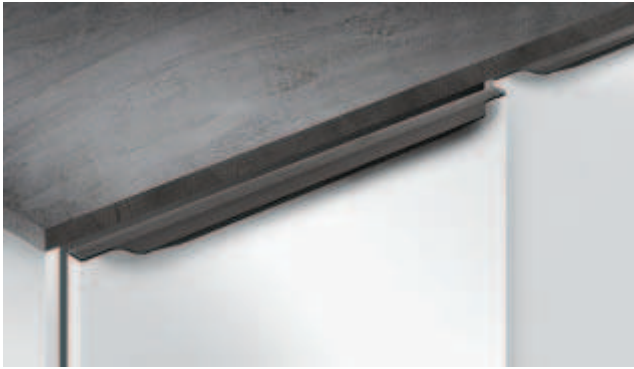

Oberfläche/Farbe	Maß A mm	für Korpusbreite mm	Artikel-Nr.
silberfarben	295	300	126.26.400
	395	400	126.26.401
	445	450	126.26.402
	495	500	126.26.403
	595	600	126.26.404
	695	700	126.26.405
	795	800	126.26.406
	895	900	126.26.407
	995	1000	126.26.408
	1195	1200	126.26.409
schwarz eloxiert	295	300	126.26.410
	395	400	126.26.411
	445	450	126.26.412
	495	500	126.26.413
	595	600	126.26.414
	695	700	126.26.415
	795	800	126.26.416
	895	900	126.26.417
	995	1000	126.26.418
	1195	1200	126.26.419
edelstahlfarben eloxiert	295	300	126.26.420
	395	400	126.26.421
	445	450	126.26.422
	495	500	126.26.423
	595	600	126.26.424
	695	700	126.26.425
	795	800	126.26.426
	895	900	126.26.427
	995	1000	126.26.428
	1195	1200	126.26.429

Abpackung: 1 Stück

**Hinweis**

Bei den Längen 300–1200 mm ist der Harpunensteg seitlich 10 mm ausgeklinkt.

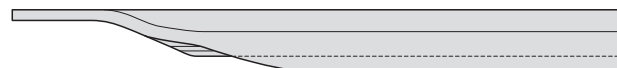

Harpunensteg ausgeklinkt

Bei Länge 2500 mm sind die Griffenden nicht ausgefräst und der Harpunensteg ist nicht ausgeklinkt.



Harpunensteg nicht ausgeklinkt

Retuschierstift zum Kaschieren der Schnittflächen ist speziell auf die Aluprofile abgestimmt:  
 silberfarben 007.33.062  
 schwarz 007.33.061  
 edelstahlfarben 007.33.060

Oberfläche	Maß A mm	Nutzlänge mm	Artikel-Nr.
silberfarben	2500	2400	126.26.430
schwarz eloxiert	2500	2400	126.26.431
edelstahlfarben eloxiert	2500	2400	126.26.432

Abpackung: 1 Stück

DGH-M 2018, HIDE-de, 06/18; Maßangaben unverbindlich. Konstruktionsänderungen vorbehalten.

1

Griff-Profileleisten zeitlos

1

GAEB

CAD

Griff-Profileleisten zeitlos

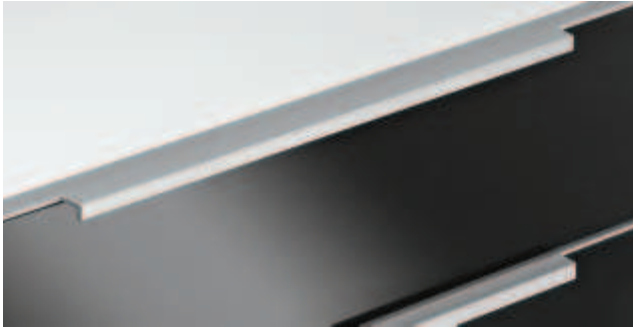

Sollten Sie in einem Möbelstück Griff-Profileleisten in Standardmaßen mit Topco Griff-Profileleisten kombinieren, dann bestellen Sie bitte auch die Standardmaße als Topco Leistung. Somit kann ein einheitliches Erscheinungsbild in den Oberflächen gewährleistet werden.



Oberfläche	für Korpusbreite mm	Maß A mm	Artikel-Nr.
verchromt poliert	300	295	126.26.201
	400	395	126.26.202
	450	445	126.26.203
	500	495	126.26.204
	600	595	126.26.205
	800	795	126.26.206
	900	895	126.26.207
	1000	995	126.26.208
	1200	1195	126.26.209
silberfarben eloxiert (E6/EV1)	300	295	126.26.901
	400	395	126.26.902
	450	445	126.26.903
	500	495	126.26.904
	600	595	126.26.905
	800	795	126.26.906
	900	895	126.26.907
	1000	995	126.26.908
	1200	1195	126.26.909
edelstahlfarben	300	295	126.26.001
	400	395	126.26.002
	450	445	126.26.003
	500	495	126.26.004
	600	595	126.26.005
	800	795	126.26.006
	900	895	126.26.007
	1000	995	126.26.008
	1200	1195	126.26.009

Abpackung: 1 Stück

### Hinweis

Bei den Längen 300–1200 mm ist der Harpunensteg seitlich 35,5 mm ausgeklinkt.



Harpunensteg ausgeklinkt

Oberfläche	Länge mm	Nutzlänge mm	Artikel-Nr.
silberfarben eloxiert (E6/EV1)	2500	2400	126.26.912
	2500	2400	126.26.012

Abpackung: 1 Stück

### Hinweis

Bei Länge 2500 mm sind die Griffenden nicht ausgefräst und der Harpunensteg ist nicht ausgeklinkt.



Harpunensteg nicht ausgeklinkt

Retuschierstift edelstahlfarben 007.33.060  
Retuschierstift schwarz 007.33.061  
Retuschierstift silberfarben 007.33.062

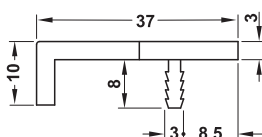
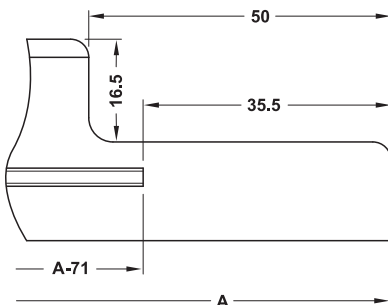

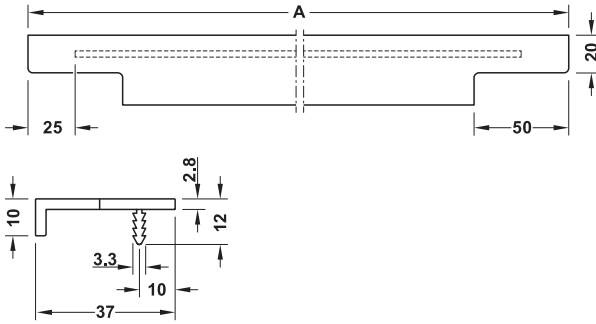

Oberfläche	für Korpusbreite mm	Maß A mm	Abpackung Stück	Artikel-Nr.
schwarz eloxiert gebürstet	300	297	1 oder 15	126.14.200
	400	397	1 oder 15	126.14.201
	450	447	1 oder 10	126.14.202
	500	497	1 oder 10	126.14.203
	600	597	1 oder 10	126.14.204
	800	797	1 oder 10	126.14.205
	900	897	1 oder 5	126.14.206
1000	997	1 oder 5	126.14.207	
1200	1197	1 oder 5	126.14.208	

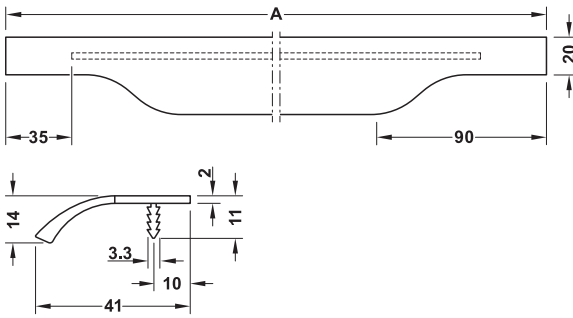

Oberfläche	für Korpusbreite mm	Maß A mm	Abpackung Stück	Artikel-Nr.
edelstahl-farben	300	297	1 oder 15	126.26.502
	400	397	1 oder 15	126.26.512
	450	447	1 oder 10	126.26.522
	500	497	1 oder 10	126.26.532
	600	597	1 oder 10	126.26.542
	800	797	1 oder 10	126.26.552
	900	897	1 oder 5	126.26.562
	1000	997	1 oder 5	126.26.572
	1200	1197	1 oder 5	126.26.582
	grau eloxiert gebürstet	300	297	1 oder 15
400		397	1 oder 15	126.26.511
450		447	1 oder 10	126.26.521
500		497	1 oder 10	126.26.531
600		597	1 oder 10	126.26.541
800		797	1 oder 10	126.26.551
900		897	1 oder 5	126.26.561
1000		997	1 oder 5	126.26.571
1200		1197	1 oder 5	126.26.581
schwarz eloxiert gebürstet		300	297	1 oder 15
	400	397	1 oder 15	126.26.510
	450	447	1 oder 10	126.26.520
	500	497	1 oder 10	126.26.530
	600	597	1 oder 10	126.26.540
	800	797	1 oder 10	126.26.550
	900	897	1 oder 5	126.26.560
	1000	997	1 oder 5	126.26.570
	1200	1197	1 oder 5	126.26.580

DGH-M 2018, HDE-de, 06/18; Maßangaben unverbindlich. Konstruktionsänderungen vorbehalten.

Griff-Profilleisten, Aluminium

**DIESE SEITE WURDE BEWUSST  
LEER GELASSEN**

**INTENTIONAL BLANK PAGE**

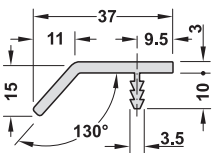
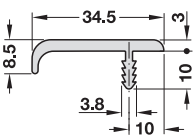
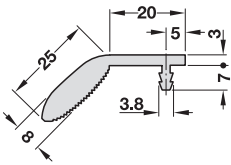

> Oberfläche: silberfarben eloxiert (E6/EV1)

Länge mm	Nutzlänge mm	Artikel-Nr.
2500	2450	126.33.925

Abpackung: 1 Stück

### Hinweis

Die Griffenden sind nicht ausgefräst und der Harpunensteg ist nicht ausgeklinkt.

> Werkstoff: Aluminium

Länge mm	Oberfläche	Artikel-Nr.
2500	silberfarben eloxiert (E6/EV1)	126.15.900
	vernickelt gebürstet	155.01.634

Abpackung: 1 Stück

> Oberfläche: silberfarben eloxiert (E6/EV1)

Länge mm	Nutzlänge mm	Artikel-Nr.
2500	2450	126.40.925

Abpackung: 1 Stück

### Hinweis

Retuschierstift 007.33.062 zum Kaschieren der Schnittflächen ist speziell auf silberfarbene Aluprofile abgestimmt.

1



Griff-Profileleisten zeitlos

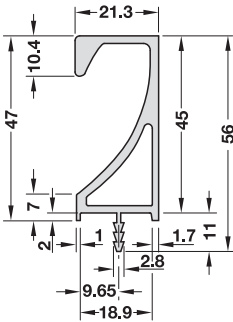
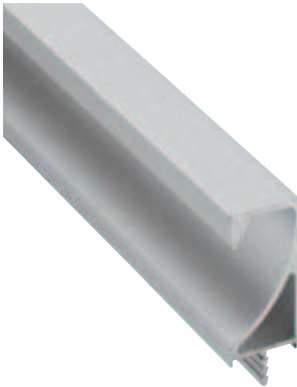

- > Länge: 2500 mm
- > Nutzlänge: 2450 mm

Oberfläche	Artikel-Nr.
silberfarben eloxiert (E6/EV1)	126.39.925
edelstahlfarben eloxiert (E6)	126.39.025

Abpackung: 1 Stück

→ Endkappe

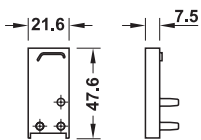
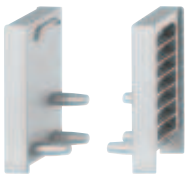

rechte Ausführung

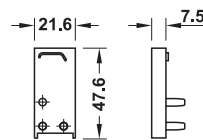

linke Ausführung

- > Einsatzbereich: für Griffprofil 126.39.925 und 126.39.025
- > Werkstoff: Kunststoff

Oberfläche	Anschlag	Artikel-Nr.
silberfarben	rechts	126.39.997
	links	126.39.998
edelstahlfarben	rechts	126.39.097
	links	126.39.098

Abpackung: 1 oder 50 Stück

DGH-M 2018; HDE-de, 06/18; Maßangaben unverbindlich. Konstruktionsänderungen vorbehalten.





1



Griff-Profilleisten zeitlos

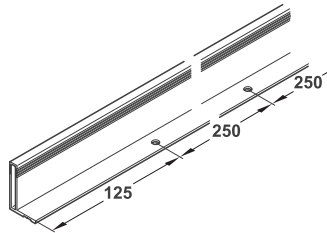
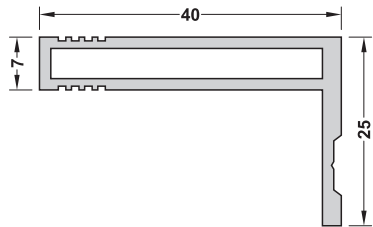

> Einsatzbereich: zum Schrauben für Holzschiebetüren, passend für EKU Combino 60, Schiebetürbeschlag

Länge mm	Oberfläche	Artikel-Nr.
2500	silberfarben eloxiert	126.12.900
	edelstahlfarben eloxiert	155.01.670
	schwarz RAL9017 matt	155.01.671

Abpackung: 1 Stück

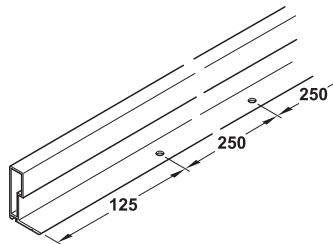
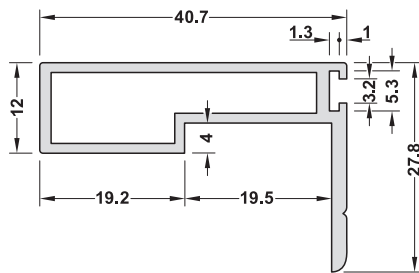

In die Nut kann die Bürstendichtung (403.54.550) eingeschoben werden.



> Einsatzbereich: zum Öffnen/Schließen von Holzschiebetüren  
> Oberfläche: silberfarben eloxiert

Länge mm	Artikel-Nr.
2500	400.51.440

Abpackung: 1 Stück

Spanplattenschrauben Hospa Senkkopf Ø 3,5 mm ► MB 1.470

DGH-M 2018, HIDE-de, 06/18; Maßangaben unverbindlich. Konstruktionsänderungen vorbehalten.

15.08.2018  
ID 4161

1



Griff-Profilleisten zeitlos

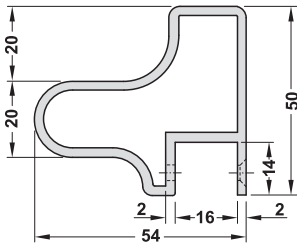

Anwendung: **A** Griffprofileiste

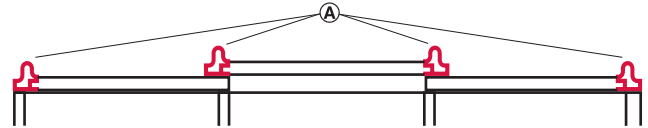

- > Einsatzbereich: geeignet für 20 mm dicke Schiebetüren mit und ohne Spiegel
- > Oberfläche: silberfarben eloxiert (E6/EV1)

Länge mm	Artikel-Nr.
2500	126.90.907

Abpackung: 1 Stück

→ Bürstendichtung

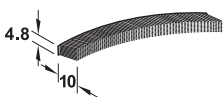

- > Einsatzbereich: für Schiebetüren, zum Schutz des Schrankinneren von Staub
- > verwendbar für: Rahmenprofil 10, seitlich, Rahmenprofil 50, seitlich zum Kleben auf Rahmenprofile
- > Montage:
- > Werkstoff: Kunsthaar
- > Farbe: grau

Länge mm	Artikel-Nr.
2500	403.54.550

Abpackung: 1 Stück

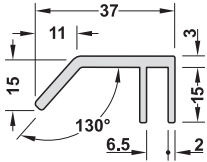
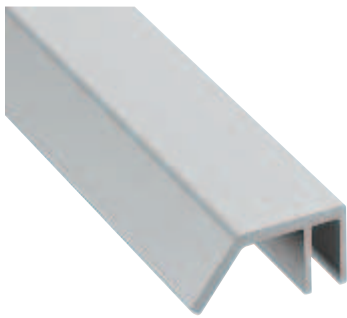

- > Einsatzbereich: für Möbeltüren aus Ganzglas
- > Oberfläche: silberfarben eloxiert (E6/EV1)

Länge mm	Nutzlänge mm	Artikel-Nr.
2500	2400	126.41.925

Abpackung: 1 Stück

### Bestellhinweis

Zum Verkleben des Glases mit dem Griffprofil empfehlen wir Kraftkleber Kristall 290 ml Artikel-Nr. 003.50.165.



### Hinweis

Retuschierstift 007.33.062 zum Kaschieren der Schnittflächen ist speziell auf silberfarbene Aluprofile abgestimmt.

## Verstärkungsleiste

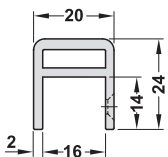

### Anwendung: A Verstärkungsleiste

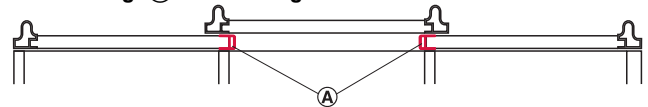

- > Einsatzbereich: zur Stabilisierung des Türflügels
- > Oberfläche: silberfarben eloxiert (E6/EV1)
- > Montage: zum Schrauben

Länge mm	Artikel-Nr.
2500	126.91.904

Abpackung: 1 Stück

## U-Profil

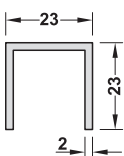

- > Oberfläche: silberfarben eloxiert (E6/EV1)

Länge mm	Artikel-Nr.
2500	126.94.900

Abpackung: 1 Stück

DGH-M 2018, HIDE-de, 06/18; Maßangaben unverbindlich. Konstruktionsänderungen vorbehalten.

Griff-Profilleisten zeitlos

1



Griffe für Faltschiebetüren zeitlos

Griffrohr zum Ablängen



→ Rohr 14 x 16 mm, zum Ablängen



> Werkstoff: Aluminium  
> Oberfläche: verchromt matt

Länge mm	Artikel-Nr.
500	111.41.900
1000	111.41.901

Abpackung: 1 Stück

→ Endstück

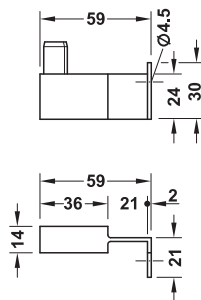
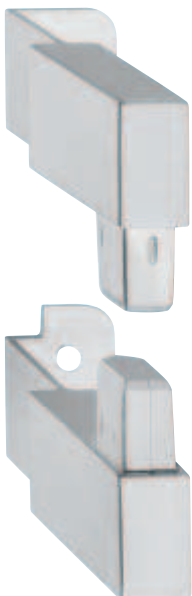

> Werkstoff: Zinkdruckguss

Oberfläche	Artikel-Nr.
verchromt matt	111.41.400

Abpackung: 1 oder 50 Stück

**Hinweis**

Die Endstücke sind auch ohne Anschraubtasche erhältlich.

Endstücke ohne Anschraubtasche ▶ MB 1.212

Spanplattenschrauben Hospa Senkkopf Ø 4 mm ▶ MB 1.470

DGH-M 2018; HDE-de, 06/18; Maßangaben unverbindlich. Konstruktionsänderungen vorbehalten.



Oberfläche	Artikel-Nr.
verchromt matt	103.98.456
edelstahlfarben	103.98.056

Abpackung: 1 oder 25 Stück

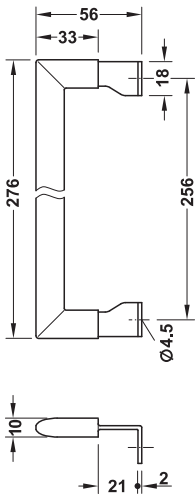

DGH-M 2018, HIDE-de, 06/18; Maßangaben unverbindlich. Konstruktionsänderungen vorbehalten.

Spanplattenschrauben Hospa Senkkopf Ø 4,0 mm ► MB 1.470

1



Griffe für Faltschiebetüren zeitlos

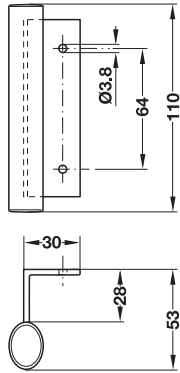

Oberfläche	Artikel-Nr.
vernickelt matt	103.99.610

Abpackung: 1 oder 25 Stück

Panheadschrauben Hospa Ø 3,5 mm ▶ MB 1.470

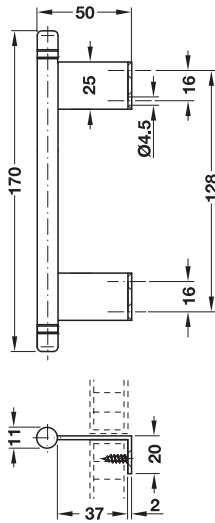

Oberfläche	Artikel-Nr.
verchromt poliert	117.99.200

Abpackung: 1 oder 25 Stück

Panheadschrauben Hospa Ø 4 mm ▶ MB 1.470

Adapter für Faltschiebetüren

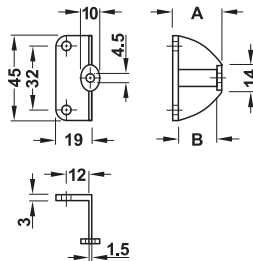

Oberfläche	für Türdicke mm	Maß A mm	Maß B mm	Artikel-Nr.
aluminiumfarben	20	26	20	109.94.901
	25	31	25	109.94.902

Abpackung: 1 oder 50 Stück

Spanplattenschrauben Hospa Senkkopf Ø 4 mm ▶ MB 1.470

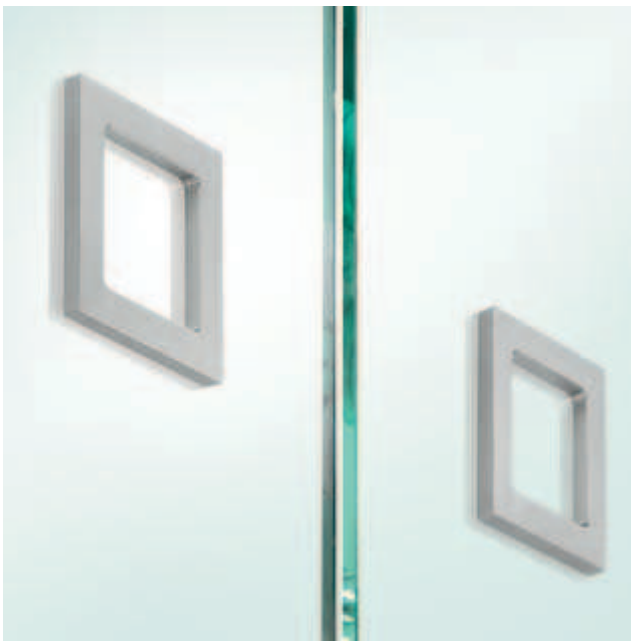

- > Werkstoff: Edelstahl, Güte 1.4301/AISI 304
- > Oberfläche: matt gebürstet
- > Montage: zum Aufkleben
- > Einsatzbereich: für Glasschiebetüren

Maß A mm	Maß B mm	Maß C mm	Artikel-Nr.
50	30	6	151.77.011
75	50	6	151.77.012

Abpackung: 1 oder 10 Stück

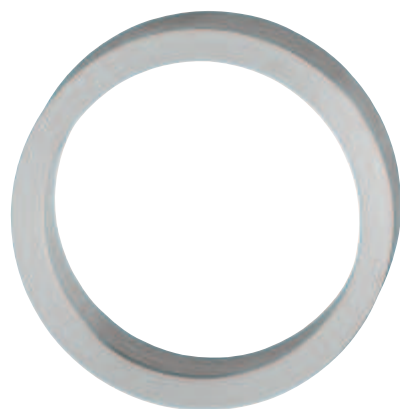
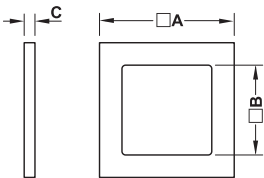

- > Werkstoff: Edelstahl, Güte 1.4301/AISI 304
- > Oberfläche: matt
- > Montage: zum Aufkleben
- > Einsatzbereich: für Glasschiebetüren

Maß A mm	Maß B mm	Maß C mm	Artikel-Nr.
59	46	6	151.77.001
79	65	7	151.77.002

Abpackung: 1 oder 10 Stück

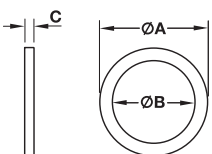



1



Griffe für Glastüren zeitlos

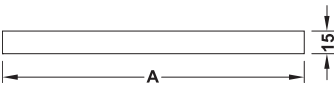
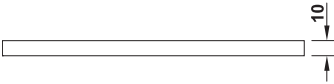

> Werkstoff: Aluminium  
> Montage: zum Aufkleben, doppelseitiges Klebeband ist vormontiert

Oberfläche	Maß A mm	Artikel-Nr.
silberfarben eloxiert	200	905.01.161
	400	905.01.171
edelstahlfarben eloxiert	200	905.01.160
	400	905.01.170

Abpackung: 1 Paar

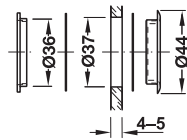

- > Werkstoff: Messing
- > Montage: zum Einschrauben
- > für Glasdicke: 4–5 mm

Oberfläche	Artikel-Nr.
vernickelt poliert	154.00.727

Abpackung: 1 oder 25 Stück

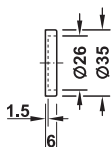
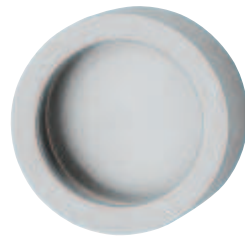

- > Werkstoff: Messing
- > Montage: zum Aufkleben

Oberfläche	Artikel-Nr.
verchromt poliert	151.63.202
verchromt matt	151.63.402

Abpackung: 1 oder 10 Stück

Glasklebertechnik mit Aktivator

► MB 14.18

DGH-M 2018, HIDE-de, 06/18; Maßangaben unverbindlich. Konstruktionsänderungen vorbehalten.

1



Griffe für Glastüren zeitlos

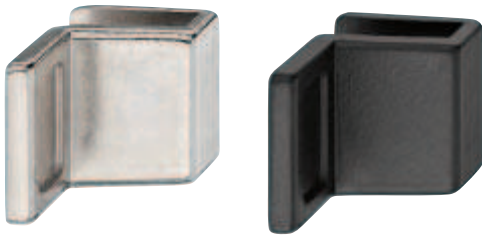

- > Werkstoff: Zinkdruckguss
- > Ausführung: mit Stahlklemmschraube und aufgesetztem Kunststoffpuffer
- > für Glasdicke: 4–6 mm
- > Befestigungsmaterial im Lieferumfang enthalten

Oberfläche	Artikel-Nr.
vernickelt poliert	154.22.717
schwarz matt	154.22.313

Abpackung: 1 oder 100 Stück

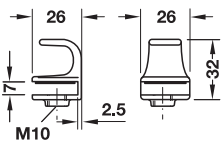
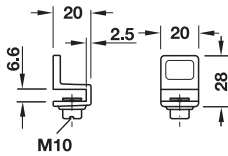

- > Montage: zum Aufkleben
- > Ausführung: mit Kunststoffschraube und Filzunterlage
- > für Glasdicke: 4–6 mm
- > Befestigungsmaterial im Lieferumfang enthalten

Oberfläche	Artikel-Nr.
vernickelt matt	154.18.701

Abpackung: 1 oder 20 Stück

Glasklebertechnik mit Aktivator ▶ MB 14.18

DGH-M 2018; HDE-de, 06/18; Maßangaben unverbindlich. Konstruktionsänderungen vorbehalten.

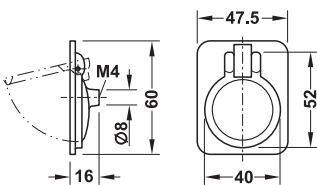
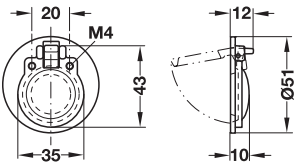

> Werkstoff: Messing

Oberfläche	Abpackung Stück	Artikel-Nr.
vernickelt matt	1 oder 50	161.16.600

> Werkstoff: Messing

Oberfläche	Artikel-Nr.
verchromt poliert	155.01.570
vernickelt matt	155.01.571
matt	155.01.572

Abpackung: 1 oder 20 Stück

Gewindeschrauben M4

► MB 1.470

DGH-M 2018, HDE-de, 06/18; Maßangaben unverbindlich. Konstruktionsänderungen vorbehalten.

Bootslook-Beschläge, Beschriftungsrahmen, Applikationen, Schlüsselschilder

1



Bootslook-Beschläge, Beschriftungsrahmen, Applikationen, Schlüsselschilder

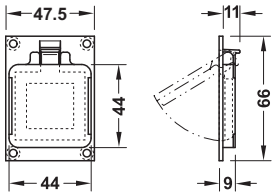

> Befestigungsmaterial im Lieferumfang enthalten

Oberfläche	Artikel-Nr.
verchromt poliert	161.15.230
vernickelt matt	161.15.630
matt	161.15.530

Abpackung: 1 oder 50 Stück

DGH-M 2018; HDE-de, 06/18; Maßangaben unverbindlich. Konstruktionsänderungen vorbehalten.



Dieser Griff mit integriertem Beschriftungsfeld eignet sich besonders für Medikamenten- und Aktenschränke, Apothekeauszüge und Möbel, auf deren Inhalt schnell und zuverlässig zugegriffen werden muss. Eine Beschriftung am Möbel erspart zeitaufwendiges Suchen.



1

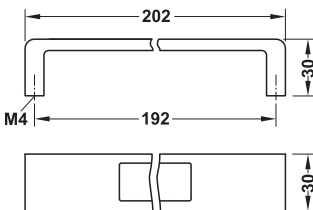
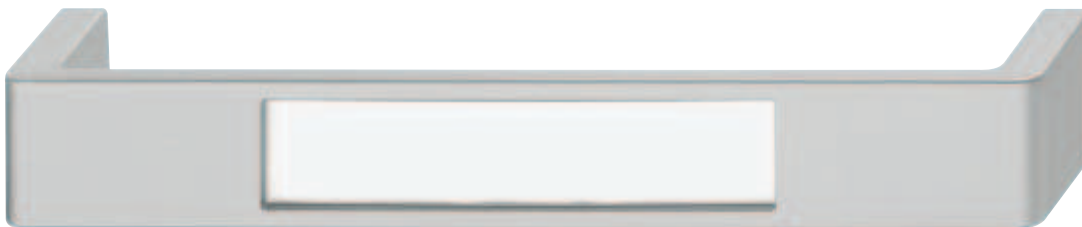
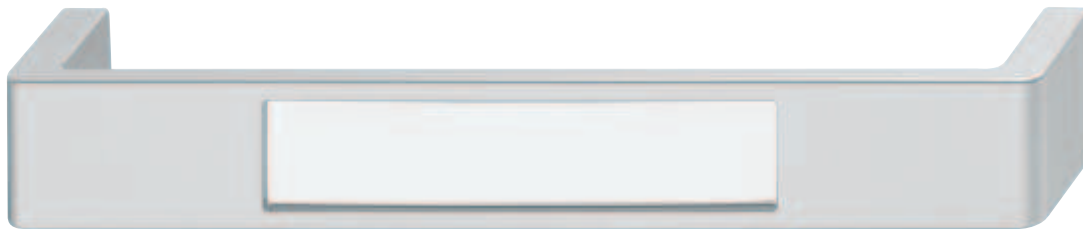

- > Werkstoff: Zinkdruckguss
- > Ausführung: mit Beschriftungsfeld, Fenstergröße 98 x 20 mm, Etikettengröße 103 x 20 mm
- > Kunststoffabdeckung im Lieferumfang enthalten

Oberfläche	Artikel-Nr.
verchromt matt	101.13.474
edelstahlfarben	101.13.074

Abpackung: 1 oder 25 Stück

Möbelgriff ohne Beschriftungsfeld	► MB 1.175
Gewindeschrauben M4	► MB 1.470

DGH-M 2018, HDE-de, 06/18; Maßangaben unverbindlich. Konstruktionsänderungen vorbehalten.

Bootslook-Beschläge, Beschriftungsrahmen, Applikationen, Schlüsselschilder

Beschriftungsclip

1

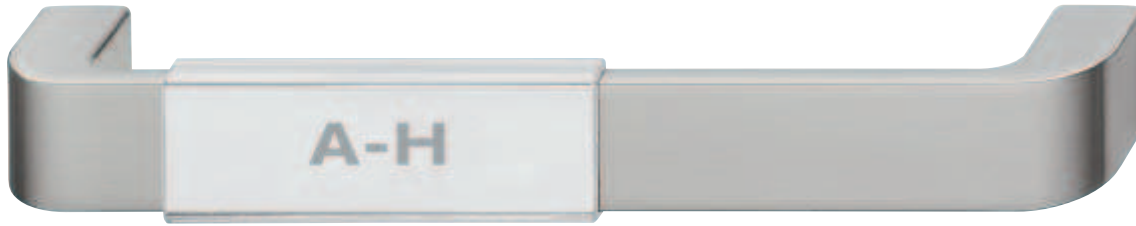

Anwendungsbeispiel

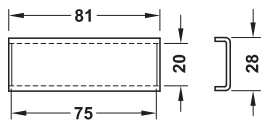

- > Werkstoff: Kunststoff
- > Ausführung: zum Aufclipsen auf Griffe, Artikel-Nr. 101.13.434 und 101.13.034
- > Papiereinlagen sind im Lieferumfang nicht enthalten

Oberfläche	Artikel-Nr.
transparent	101.13.499

Abpackung: 1 oder 25 Stück

passender Bügelgriff ▶ MB 1.176

Gewindeschrauben M4 ▶ MB 1.470

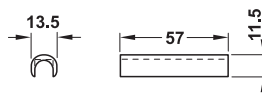

Anwendungsbeispiel

- > Werkstoff: Kunststoff
- > Ausführung: zum Aufclipsen auf 10 mm Rundstangengriffe, auf Blickwinkel drehbar

Oberfläche	Artikel-Nr.
transparent	168.06.400

Abpackung: 1 oder 100 Stück

Bootslook-Beschläge, Beschriftungsrahmen, Applikationen, Schlüsselschilder



Etikettenrahmen

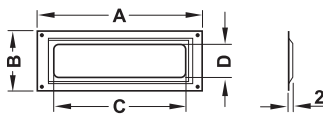

> Werkstoff: Stahl  
> Oberfläche: vernickelt

Maß A mm	Maß B mm	Maß C mm	Maß D mm	Etikettengröße mm	Artikel-Nr.
59	21	47	10	52 x 14	168.00.713
65	24	50	12	55 x 16	168.00.721
72	24	57	13	61 x 16	168.00.733
79	29	63	15	68 x 18	168.00.743

Abpackung: 1 oder 100 Stück

**Bestellhinweis**

Für Etikettenrahmen mit der Größe 59 x 20 mm  
Rundkopf-Metallstifte mit Durchmesser 0,9 mm verwenden.  
Für die restlichen Etikettenrahmen Rundkopf-Metallstifte mit  
Durchmesser 1,6 mm verwenden.

Rundkopf-Metallstifte Ø 1,6 mm	► MB 1.470
Rundkopf-Metallstifte Ø 0,9 mm	► MB 1.470

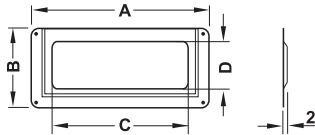

> Werkstoff: Stahl  
> Oberfläche: vernickelt

Maß A mm	Maß B mm	Maß C mm	Maß D mm	Etikettengröße mm	Artikel-Nr.
65	37	48	20	53 x 30	168.02.762
85	43	65,5	25	73 x 35	168.02.772
95	55	75	35	84 x 45	168.02.782

Abpackung: 1 oder 100 Stück

Rundkopf-Metallstifte Ø 1,6 mm	► MB 1.470
--------------------------------	------------



1



> Werkstoff: Aluminium  
> Ausführung: mit Papierstreifen und Celluloideinlage

Oberfläche/Farbe	Artikel-Nr.
silberfarben matt eloxiert	155.01.140

Abpackung: 1, 25 oder 200 Stück

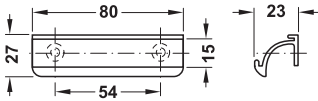

Bootslook-Beschläge, Beschriftungsrahmen, Applikationen, Schlüsselschilder

Applikationen – Topco

Diese Applikationen können zur Vermeidung von Fingerabdrücken auf grifflosen Fronten mit Push-to-open-Beschlägen, als Orientierungshilfe bei grifflosen Drehtüren oder als gestalterisches Element für Möbel eingesetzt werden.



- > Werkstoff: Edelstahl, Güte 1.4301
- > Oberfläche: geschliffen
- > Ausführung: mit rückseitigem Klebeband

Maß A mm	Artikel-Nr.
30	108.10.001

Abpackung: 1 oder 10 Stück

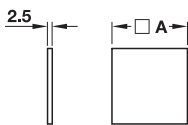

- > Werkstoff: Edelstahl, Güte 1.4301
- > Oberfläche: geschliffen
- > Ausführung: mit rückseitigem Klebeband

Maß A mm	Artikel-Nr.
20	108.10.010
40	108.10.011

Abpackung: 1 oder 10 Stück

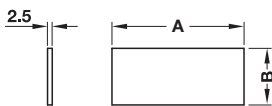

- > Werkstoff: Edelstahl, Güte 1.4301
- > Oberfläche: geschliffen
- > Ausführung: mit rückseitigem Klebeband

Maß A mm	Maß B mm	Artikel-Nr.
30	15	108.10.020
70	30	108.10.021

Abpackung: 1 oder 10 Stück



Anwendungsbeispiel Laser-Beschriftung

**topCo** KUNDENINDIVIDUELL  
BEREITS AB EINEM STÜCK

Die Edelstahl-Applikationen 108.10. sind auch mit einer Logo-Beschriftung erhältlich.

Lasert-Beschriftung ▶ MB 1.206

Diese Applikationen können zur Vermeidung von Fingerabdrücken auf grifflosen Fronten mit Push-to-open-Beschlägen, als Orientierungshilfe bei grifflosen Drehtüren oder als gestalterisches Element für Möbel eingesetzt werden.



Bootslook-Beschläge, Beschriftungsrahmen, Applikationen, Schlüsselschilder

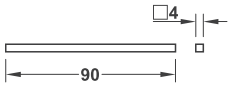
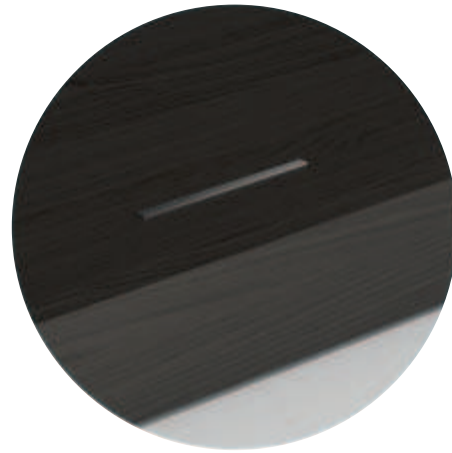

> Werkstoff: Edelstahl, Güte 1.4301  
> Montage: zum Einlassen

Oberfläche	Artikel-Nr.
geschliffen	108.10.030

Abpackung: 1 Stück

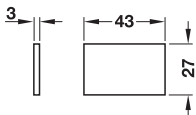

> Werkstoff: Zinkdruckguss  
> Montage: zum Kleben

Oberfläche	Artikel-Nr.
silberfarben	108.15.900

Abpackung: 1 oder 20 Stück

**Bestellhinweis**

Zum Verkleben empfehlen wir Kontaktkleber 003.56.910.

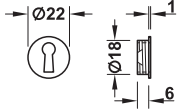

> Werkstoff: Zinkdruckguss

Oberfläche	Artikel-Nr.
vernickelt matt	181.03.610

Abpackung: 1 oder 25 Stück

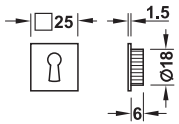

> Werkstoff: Zinkdruckguss

Oberfläche	Artikel-Nr.
vernickelt matt	181.01.600

Abpackung: 1 oder 25 Stück

DGH-M 2018, HDE-de, 06/18; Maßangaben unverbindlich. Konstruktionsänderungen vorbehalten.

1



Bootslook-Beschläge, Beschriftungsrahmen, Applikationen, Schlüsselschilder

# 1

# HÄFELE

TRADITIONELL.  
NOSTALGISCH UND EHRlich.



Häfele Design Modell H1970

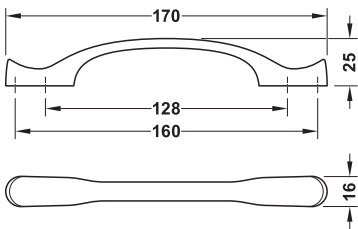

Oberfläche/Farbe	Artikel-Nr.
braun durchgerieben	106.69.000
verzinkt antik	106.69.001
vermessingt antik	106.69.002

Abpackung: 1, 25 oder 100 Stück

DGH-M 2018, HIDE-de, 06/18; Maßangaben unverbindlich. Konstruktionsänderungen vorbehalten.

Gewindeschrauben M4

► MB 1.470

Möbelgriffe traditionell

1



**DIESE SEITE WURDE BEWUSST  
LEER GELASSEN**

**INTENTIONAL BLANK PAGE**



Bei diesen Griffen wurden bewusst Gebrauchsspuren eingearbeitet. Dadurch ist jeder Griff ein Unikat.



1



Möbelgriffe traditionell

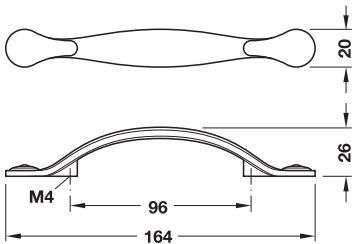

Oberfläche	Artikel-Nr.
eisenfarben, Used Look	123.99.084

Abpackung: 1 oder 25 Stück

Passender Möbelknopf	► MB 1.347
Gewindeschrauben M4	► MB 1.470

DGH-M 2018, HIDE-de, 06/18; Maßangaben unverbindlich. Konstruktionsänderungen vorbehalten.



Diese Möbelgriffe können mit oder ohne Rückplatte montiert werden.

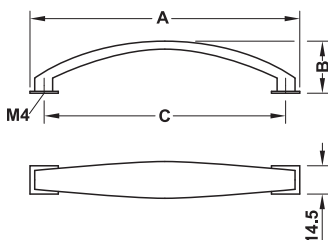
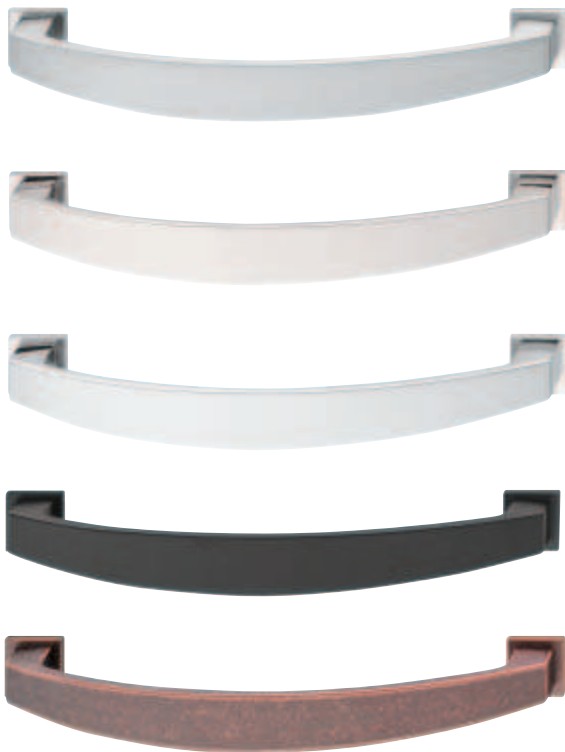

Oberfläche/Farbe	Maß A mm	Maß B mm	Maß C mm	Artikel-Nr.
edelstahlfarben	138	26	128	103.30.105
	170	26	160	103.30.106
vernickelt poliert	138	26	128	103.30.705
	170	26	160	103.30.706
verchromt poliert	138	26	128	103.30.205
	170	26	160	103.30.206
schwarz matt, RAL 9017	138	26	128	103.30.805
	170	26	160	103.30.806
verkupfert antik	138	26	128	103.30.005
	170	26	160	103.30.006

Abpackung: 1, 20 oder 120 Stück

passende Möbelknöpfe ▶ MB 1.342 H

passende Muschelgriffe ▶ MB 1.338 C

Gewindeschrauben M4 ▶ MB 1.470

**DIESE SEITE WURDE BEWUSST  
LEER GELASSEN**

**INTENTIONAL BLANK PAGE**

1



Möbelgriffe traditionell

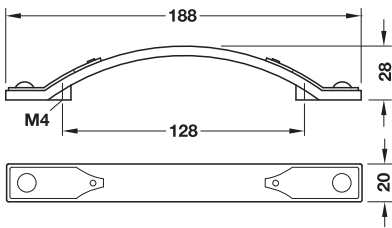

Oberfläche/Farbe	Artikel-Nr.
braun durchgerieben, Used Look	110.38.103
schwarz antik, Used Look	110.38.303

Abpackung: 1 oder 50 Stück

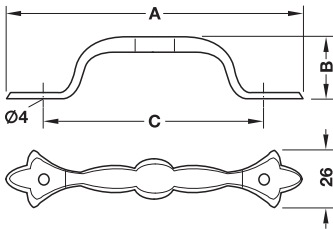

- > Oberfläche: schwarz antik, Used Look
- > Befestigungsmaterial im Lieferumfang enthalten

Maß A mm	Maß B mm	Maß C mm	Artikel-Nr.
128	27	96	119.75.312
157	27	128	119.75.321

Abpackung: 1 oder 25 Stück

Gewindeschrauben M4

► MB 1.470

DGH-M 2018; HDE-de, 06/18; Maßangaben unverbindlich. Konstruktionsänderungen vorbehalten.

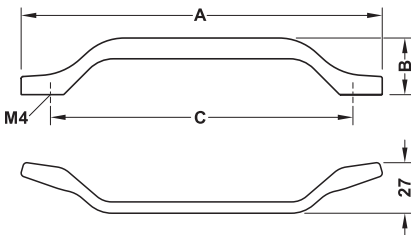

Oberfläche/ Farbe	Maß A mm	Maß B mm	Maß C mm	Abpackung Stück	Artikel-Nr.
vermessingt	127	31	96	1 oder 10	110.22.080
	191	31	160	1 oder 10	110.22.081
	351	31	320	1 oder 25	110.22.082
graphit	127	31	96	1 oder 10	110.22.050
	191	31	160	1 oder 10	110.22.086
	351	31	320	1 oder 25	110.22.089

DGH-M 2018, HDE-de, 06/18; Maßangaben unverbindlich. Konstruktionsänderungen vorbehalten.

Gewindeschrauben M4

► MB 1.470

06.09.2019  
 ID 4629

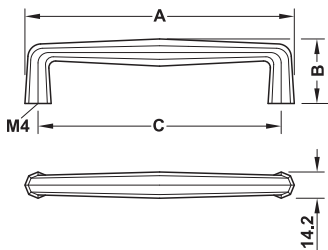

Oberfläche/ Farbe	Maß A mm	Maß B mm	Maß C mm	Abpackung	Artikel-Nr.
vernickelt poliert	109	33	96	1 oder 40	155.02.040
	144	35	128	1 oder 30	155.02.050
	176	37	160	1 oder 25	155.02.060
	212	40	192	1 oder 20	155.02.070
verzinkt antik	109	33	96	1 oder 40	155.02.041
	144	35	128	1 oder 30	155.02.051
	176	37	160	1 oder 25	155.02.061
	212	40	192	1 oder 20	155.02.071
bronzefarben geölt gebürstet	109	33	96	1 oder 40	155.02.042
	144	35	128	1 oder 30	155.02.052
	176	37	160	1 oder 25	155.02.062
	212	40	192	1 oder 20	155.02.072
vermessingt gebürstet	109	33	96	1 oder 40	155.02.043
	144	35	128	1 oder 30	155.02.053
	176	37	160	1 oder 25	155.02.063
	212	40	192	1 oder 20	155.02.073
verkupfert gebürstet	109	33	96	1 oder 40	155.02.044
	144	35	128	1 oder 30	155.02.054
	176	37	160	1 oder 25	155.02.064
	212	40	192	1 oder 20	155.02.074

passende Möbelknöpfe ▶ MB 1.342 D

Gewindeschrauben M4 ▶ MB 1.470



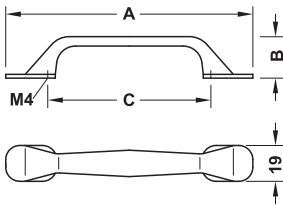

Oberfläche/Farbe	Maß A mm	Maß B mm	Maß C mm	Artikel-Nr.
verchromt poliert	131	24	96	155.01.770
edelstahlfarben	131	24	96	155.01.771

Abpackung: 1, 20 oder 120 Stück

Möbelgriffe traditionell

DGH-M 2018, HDE-de, 06/18; Maßangaben unverbindlich. Konstruktionsänderungen vorbehalten.

Gewindeschrauben M4

► MB 1.470

06.09.2019  
 ID 4629

**DIESE SEITE WURDE BEWUSST  
LEER GELASSEN**

**INTENTIONAL BLANK PAGE**



Oberfläche	Artikel-Nr.
poliert	102.57.824

Abpackung: 1 oder 20 Stück

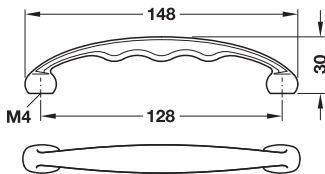
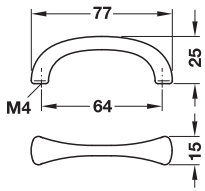

Oberfläche	Artikel-Nr.
poliert	107.60.803

Abpackung: 1 oder 25 Stück

DGH-M 2018, HIDE-de, 06/18; Maßangaben unverbindlich. Konstruktionsänderungen vorbehalten.

1



Möbelgriffe traditionell

Gewindeschrauben M4

► MB 1.470

1

Möbelgriffe traditionell

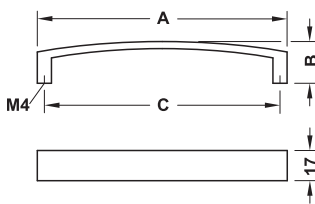

Oberfläche/Farbe	Maß A mm	Maß B mm	Maß C mm	Artikel-Nr.
vernickelt gebürstet	136	25	128	155.02.150
	168	26	160	155.02.160
bronzefarben geölt gebürstet	136	25	128	155.02.151
	168	26	160	155.02.161
vermessingt gebürstet	136	25	128	155.02.152
	168	26	160	155.02.162
vernickelt poliert	136	25	128	155.02.153
	168	26	160	155.02.163

Abpackung: 1 Stück

passende Möbelknöpfe	► MB 1.342 I
passende Muschelgriffe	► MB 1.338 D
Gewindeschrauben M4	► MB 1.470

DGH-M 2018; HDE-de, 06/18; Maßangaben unverbindlich. Konstruktionsänderungen vorbehalten.

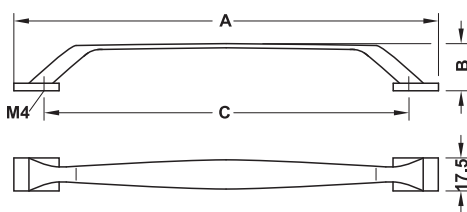

Oberfläche/Farbe	Maß A mm	Maß B mm	Maß C mm	Artikel-Nr.
vermessingt gebürstet	135	27	96	155.02.200
	165	29	128	155.02.210
	227	29	192	155.02.220
	360	46	305	155.02.230
edelstahlfarben	135	27	96	155.02.201
	165	29	128	155.02.211
	227	29	192	155.02.221
	360	46	305	155.02.231
bronzefarben geölt gebürstet	135	27	96	155.02.202
	165	29	128	155.02.212
	227	29	192	155.02.222
	360	46	305	155.02.232
vernickelt poliert	135	27	96	155.02.203
	165	29	128	155.02.213
	227	29	192	155.02.223
	360	46	305	155.02.233

Abpackung: 1 Stück

passende Möbelknöpfe ▶ MB 1.342 J

Gewindeschrauben M4 ▶ MB 1.470

1



Anwendungsbeispiel



Möbelgriffe traditionell

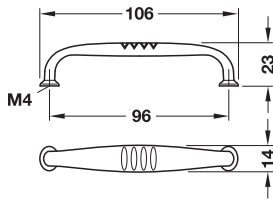
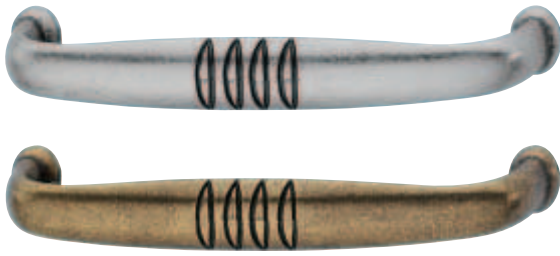

> Werkstoff: Zinkdruckguss

Oberfläche	Artikel-Nr.
verzinkt antik, Used Look	102.55.901
braun durchgerieben, Used Look	102.55.101

Abpackung: 1 oder 25 Stück

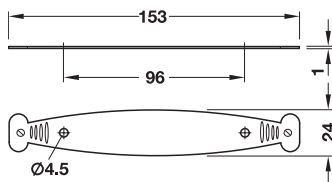

> Werkstoff: Messing

Oberfläche	Artikel-Nr.
verzinkt antik, Used Look	102.55.952
braun durchgerieben, Used Look	102.55.152

Abpackung: 1 oder 25 Stück

Gewindeschrauben M4

► MB 1.470

DGH-M 2018; HDE-de, 06/18; Maßangaben unverbindlich. Konstruktionsänderungen vorbehalten.

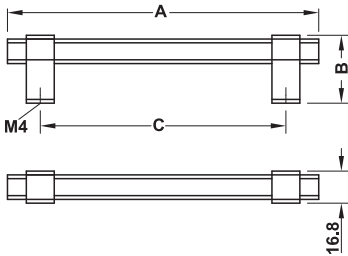

Oberfläche/Farbe	Maß A mm	Maß B mm	Maß C mm	Artikel-Nr.
verchromt poliert	163	36	128	155.01.880
	227	36	192	155.01.881
edelstahlfarben	163	36	128	155.01.890
	227	36	192	155.01.891

Abpackung: 1 oder 30 Stück

Möbelgriffe traditionell

DGH-M 2018, HIDE-de, 06/18; Maßangaben unverbindlich. Konstruktionsänderungen vorbehalten.

Gewindeschrauben M4

► MB 1.470

06.09.2019  
ID 4629



**DIESE SEITE WURDE BEWUSST  
LEER GELASSEN**

**INTENTIONAL BLANK PAGE**

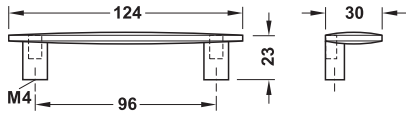

> Werkstoff: Messing

Oberfläche	Artikel-Nr.
braun durchgerieben	108.58.101

Abpackung: 1 oder 25 Stück

passender Möbelknopf ▶ MB 1.345

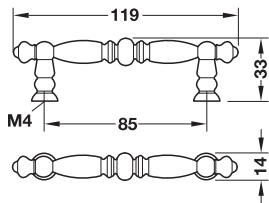

> Werkstoff: Messing

Oberfläche	Artikel-Nr.
braun durchgerieben	121.54.102

Abpackung: 1 oder 25 Stück



> Werkstoff: Griff: Messing, Sockel: Zinkdruckguss  
 > Oberfläche: Griff: verchromt poliert, Sockel: goldfarben poliert

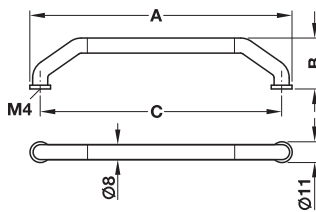

Maß A mm	Maß B mm	Maß C mm	Artikel-Nr.
139	27	128	117.47.836

Abpackung: 1 oder 10 Stück

DGH-M 2018, HIDE-de, 06/18; Maßangaben unverbindlich. Konstruktionsänderungen vorbehalten.

Gewindeschrauben M4 ▶ MB 1.470

1

Möbelgriffe traditionell

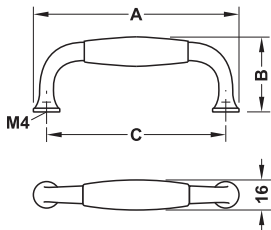

> Werkstoff: Griff: Porzellan,  
Sockel: Zinkdruckguss

Oberfläche/Farbe	Maß A mm	Maß B mm	Maß C mm	Artikel-Nr.
Griff: weiß, Sockel: verzinnt antik	110	32	96	155.02.110
Griff: weiß, Sockel: vermessingt poliert	142	33,5	128	155.02.112
	142	33,5	128	155.02.121

Abpackung: 1 Stück

passende Möbelknöpfe	► MB 1.351
passender Klöppelgriff	► MB 1.351
Gewindeschrauben M4	► MB 1.470

DGH-M 2018; HDE-de, 06/18; Maßangaben unverbindlich. Konstruktionsänderungen vorbehalten.

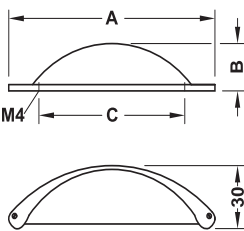

Oberfläche/Farbe	Maß A mm	Maß B mm	Maß C mm	Artikel-Nr.
eisenfarben, Used Look	104	25	64	155.01.980
verzinkt antik	104	25	64	155.01.982
vermessingt antik	104	25	64	155.01.981
edelstahlfarben	104	25	64	155.01.983
schwarz matt, RAL 9017	104	25	64	155.01.984

Abpackung: 1 Stück

passende Möbelknöpfe ▶ MB 1.342 F

Gewindeschrauben M4 ▶ MB 1.470

DGH-M 2018, HDE-de, 06/18; Maßangaben unverbindlich. Konstruktionsänderungen vorbehalten.

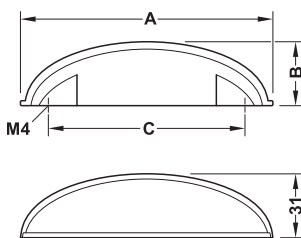
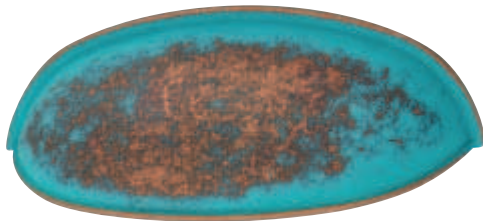

Oberfläche/Farbe	Maß A mm	Maß B mm	Maß C mm	Artikel-Nr.
bronzefarben geölt dunkel	106	31	64	105.61.300
verkupfert	106	31	64	105.61.000
vernickelt matt	106	31	64	105.61.600
verkupfert rustikal	106	31	64	105.61.014

Abpackung: 1 oder 25 Stück

passender Möbelknopf	► MB 1.342 G
Gewindeschrauben M4	► MB 1.470

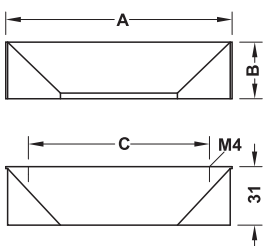

DGH-M 2018, HIDE-de, 06/18; Maßangaben unverbindlich. Konstruktionsänderungen vorbehalten.

Oberfläche/Farbe	Maß A mm	Maß B mm	Maß C mm	Artikel-Nr.
edelstahlfarben	120	30	96	118.68.104
vernickelt poliert	120	30	96	118.68.704
verchromt poliert	120	30	96	118.68.204
schwarz matt, RAL 9017	120	30	96	118.68.804
verkupfert antik	120	30	96	118.68.004

Abpackung: 1, 20 oder 80 Stück

passende Möbelgriffe	► MB 1.333 A
passende Möbelknöpfe	► MB 1.342 H
Gewindeschrauben M4	► MB 1.470

Möbelgriffe traditionell

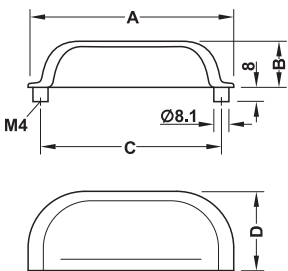

Oberfläche/Farbe	Maß A mm	Maß B mm	Maß C mm	Maß D mm	Artikel-Nr.
vernickelt gebürstet	78	21	64	35	155.02.171
	109	24	96	42	155.02.181
	202	25	192	42	155.02.191
bronzefarben geölt gebürstet	78	21	64	35	155.02.172
	109	24	96	42	155.02.182
	202	25	192	42	155.02.192
vermessingt gebürstet	78	21	64	35	155.02.170
	109	24	96	42	155.02.180
	202	25	192	42	155.02.190
vernickelt poliert	78	21	64	35	155.02.173
	109	24	96	42	155.02.183
	202	25	192	42	155.02.193

Abpackung: 1 Stück

passende Möbelknöpfe	► MB 1.342 I
passende Möbelgriffe	► MB 1.335 A
Gewindeschrauben M4	► MB 1.470



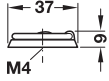

Oberfläche	Artikel-Nr.
braun durchgerieben	125.71.102

Abpackung: 1 oder 50 Stück

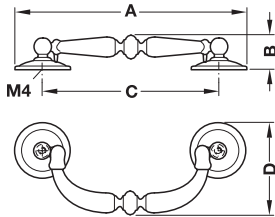

> Oberfläche: braun durchgerieben

Maß A mm	Maß B mm	Maß C mm	Maß D mm	Artikel-Nr.
88	17	64	33	125.72.101
127	20	96	50	125.72.102

Abpackung: 1 oder 25 Stück

Möbelgriffe traditionell

Passender Möbelknopf ▶ MB 1.349

Gewindeschrauben M4 ▶ MB 1.470

DGH-M 2018, HIDE-de, 06/18; Maßangaben unverbindlich. Konstruktionsänderungen vorbehalten.

1

Möbelgriffe traditionell

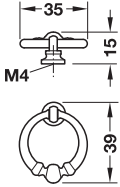

Oberfläche	Artikel-Nr.
braun durchgerieben	121.05.118

Abpackung: 1 oder 25 Stück

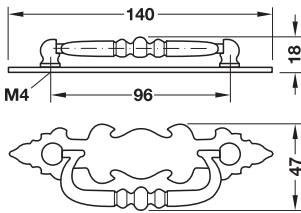

Oberfläche	Artikel-Nr.
braun durchgerieben	121.50.104

Abpackung: 1 oder 25 Stück

Gewindeschrauben M4

► MB 1.470

DGH-M 2018; HDE-de, 06/18; Maßangaben unverbindlich. Konstruktionsänderungen vorbehalten.

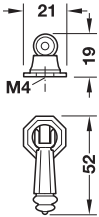

Oberfläche	Artikel-Nr.
braun durchgerieben	121.62.159

Abpackung: 1 oder 25 Stück

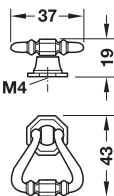

Oberfläche	Artikel-Nr.
braun durchgerieben	121.62.104

Abpackung: 1 oder 25 Stück

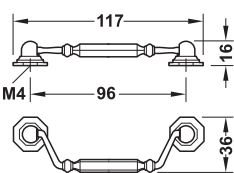

Oberfläche	Artikel-Nr.
braun durchgerieben	121.61.125

Abpackung: 1 oder 25 Stück

DGH-M 2018, HIDE-de, 06/18; Maßangaben unverbindlich. Konstruktionsänderungen vorbehalten.

Gewindeschrauben M4

► MB 1.470

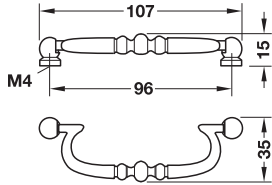
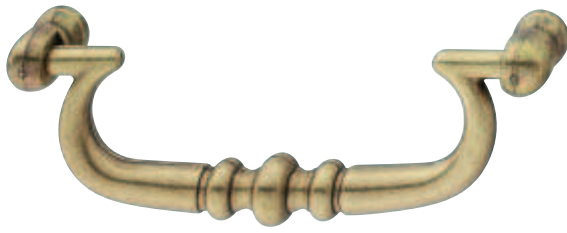

Oberfläche	Artikel-Nr.
braun durchgerieben	121.04.102

Abpackung: 1 oder 25 Stück

**Platte**

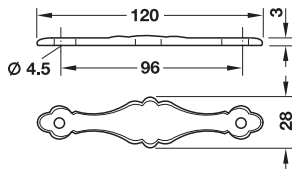

Oberfläche	Artikel-Nr.
braun durchgerieben	121.18.188

Abpackung: 1 oder 25 Stück

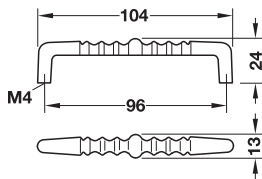

Oberfläche	Artikel-Nr.
braun durchgerieben	121.02.108

Abpackung: 1 oder 25 Stück

Gewindeschrauben M4

► MB 1.470

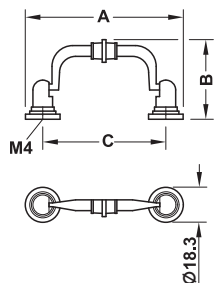

Oberfläche/Farbe	Maß A mm	Maß B mm	Maß C mm	Artikel-Nr.
braun durchgerieben	79	37	64	155.01.800

Abpackung: 1 Stück

Möbelgriffe traditionell



Diese Klöppelgriffe können mit oder ohne Rückplatte montiert werden.

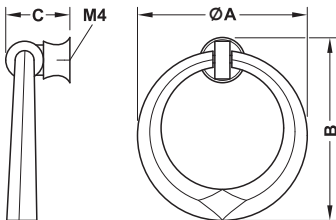

Oberfläche/Farbe	Maß A mm	Maß B mm	Maß C mm	Artikel-Nr.
bronzefarben geölt dunkel	45	49	15	120.95.330
schwarz, antik	45	49	15	120.95.320

Abpackung: 1 oder 25 Stück

**Bestellhinweis**

Rückplatte bitte separat bestellen.

Diese Möbelgriffe können mit oder ohne Rückplatte montiert werden.

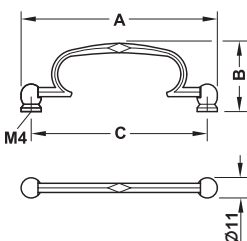
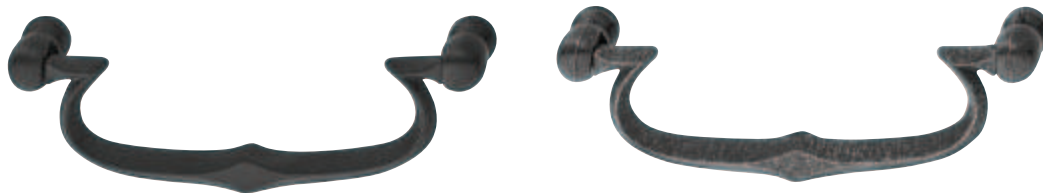

Oberfläche/Farbe	Maß A mm	Maß B mm	Maß C mm	Artikel-Nr.
bronzefarben geölt dunkel	107	15	96	120.94.330
schwarz, antik	107	15	96	120.94.320

Abpackung: 1 oder 25 Stück

**Bestellhinweis**

Rückplatte bitte separat bestellen.

Gewindeschrauben M4	► MB 1.470
passende Rückplatte	► MB 1.342 C
passende Möbelknöpfe	► MB 1.342 C

→ Rückplatte

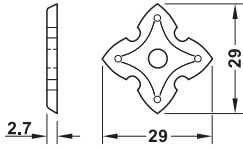

Oberfläche/Farbe	Artikel-Nr.
bronzefarben geölt dunkel	120.94.391
schwarz, antik	120.94.390

Abpackung: 1 oder 25 Stück

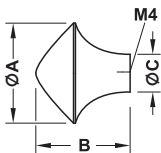

Diese Möbelknöpfe können mit oder ohne Rückplatte montiert werden.



Oberfläche/Farbe	Maß A mm	Maß B mm	Maß C mm	Artikel-Nr.
bronzefarben geölt dunkel	30	26	9	120.97.321
schwarz, antik	30	26	9	120.97.320

Abpackung: 1 oder 25 Stück

**Bestellhinweis**

Rückplatte bitte separat bestellen.

passende Möbelgriffe	► MB 1.342 B
passende Klöppelgriffe	► MB 1.342 B
Gewindeschrauben M4	► MB 1.470



1

Möbelgriffe traditionell

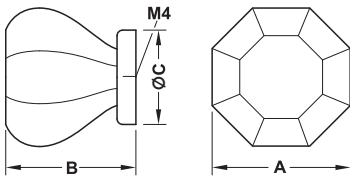

Oberfläche/Farbe	Maß A mm	Maß B mm	Maß C mm	Artikel-Nr.
bronzefarben geölt gebürstet	37	35	25	155.02.080
vermessingt gebürstet	37	35	25	155.02.081
edelstahlfarben	37	35	25	155.02.082
vernickelt poliert	37	35	25	155.02.083
verzinkt antik	37	35	25	155.02.084

Abpackung: 1 oder 30 Stück

passende Möbelgriffe	► MB 1.334 B
Gewindeschrauben M4	► MB 1.470

DGH-M 2018; HDE-de, 06/18; Maßangaben unverbindlich. Konstruktionsänderungen vorbehalten.

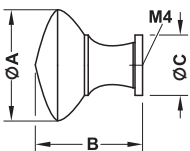

Oberfläche/Farbe	Maß A mm	Maß B mm	Maß C mm	Artikel-Nr.
vernickelt matt	30	28	16	155.01.810
verchromt gebürstet	30	28	16	155.01.811
bronzefarben geölt gebürstet	30	28	16	155.01.812
schwarz matt, RAL 9017	30	28	16	155.01.813
edelstahlfarben	30	28	16	155.01.814
verchromt poliert	30	28	16	155.01.815
bronzefarben geölt dunkel	30	28	16	155.01.816
verchromt matt	30	28	16	155.01.817

Abpackung: 1, 25 oder 200 Stück

Möbelknöpfe traditionell

Gewindeschrauben M4

► MB 1.470

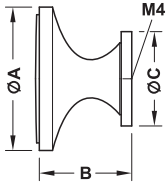

Oberfläche/Farbe	Maß A mm	Maß B mm	Maß C mm	Artikel-Nr.
verchromt poliert	38	26	25	155.01.805
edelstahlfarben	38	26	25	155.01.806

Abpackung: 1 Stück

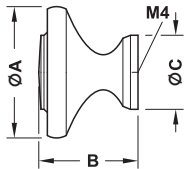

Oberfläche/Farbe	Maß A mm	Maß B mm	Maß C mm	Artikel-Nr.
eisenfarben	34	25	19	155.01.970
verzinkt antik	34	25	19	155.01.971
vermessingt antik	34	25	19	155.01.972
edelstahlfarben	34	25	19	155.01.973
schwarz matt, RAL 9017	34	25	19	155.01.974

Abpackung: 1 Stück

passende Muschelgriffe ▶ MB 1.338 A

Gewindeschrauben M4 ▶ MB 1.470

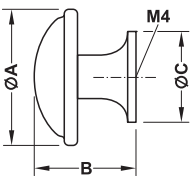

DGH-M 2018, HIDE-de, 06/18; Maßangaben unverbindlich. Konstruktionsänderungen vorbehalten.

Möbelknöpfe traditionell

Oberfläche/Farbe	Maß A mm	Maß B mm	Maß C mm	Artikel-Nr.
bronzefarben geölt dunkel	36	28	24	134.09.330
verkupfert	36	28	24	134.09.030
vernickelt matt	36	28	24	134.09.633
verkupfert rustikal	36	28	24	134.09.001

Abpackung: 1 oder 25 Stück

- passende Muschelgriffe ▶ MB 1.338 B
- Gewindeschrauben M4 ▶ MB 1.470

1

Möbelknöpfe traditionell

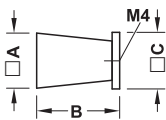

Oberfläche/Farbe	Maß A mm	Maß B mm	Maß C mm	Artikel-Nr.
edelstahlfarben	15	20	15	110.35.380
vernickelt poliert	15	20	15	110.35.381
verchromt poliert	15	20	15	110.35.382
schwarz matt, RAL 9017	15	20	15	110.35.384
verkupfert antik	15	20	15	110.35.383

Abpackung: 1, 50 oder 400 Stück

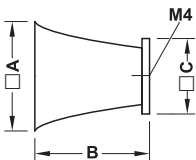

Oberfläche/Farbe	Maß A mm	Maß B mm	Maß C mm	Artikel-Nr.
edelstahlfarben	30	28	20	110.35.392
vernickelt poliert	30	28	20	110.35.391
verchromt poliert	30	28	20	110.35.390
schwarz matt, RAL 9017	30	28	20	110.35.393
verkupfert antik	30	28	20	110.35.394

Abpackung: 1, 25 oder 100 Stück

passende Möbelgriffe	► MB 1.333 A
passende Muschelgriffe	► MB 1.338 C
Gewindeschrauben M4	► MB 1.470

DGH-M 2018; HDE-de, 06/18; Maßangaben unverbindlich. Konstruktionsänderungen vorbehalten.

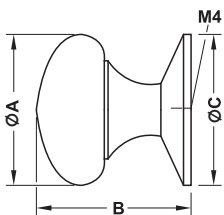
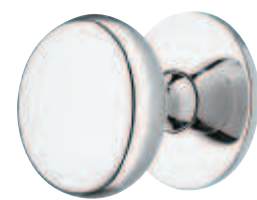

Oberfläche/ Farbe	Maß A mm	Maß B mm	Maß C mm	Abpackung Stück	Artikel-Nr.
vernickelt	32	36	32	1, 15 oder 75	155.02.250
gebürstet	38	40	38	1 oder 20	155.02.260
bronzefarben	32	36	32	1, 15 oder 75	155.02.251
geölt gebürstet	38	40	38	1 oder 20	155.02.261
vermessingt	32	36	32	1, 15 oder 75	155.02.252
gebürstet	38	40	38	1 oder 20	155.02.262
vernickelt	32	36	32	1 oder 20	155.02.253
poliert	38	40	38	1 oder 20	155.02.263

Möbelknöpfe traditionell

DGH-M 2018, HIDE-de, 06/18; Maßangaben unverbindlich. Konstruktionsänderungen vorbehalten.

passende Möbelgriffe	► MB 1.335 A
passende Muschelgriffe	► MB 1.338 D
Gewindeschrauben M4	► MB 1.470

06.09.2019  
ID 4629

1

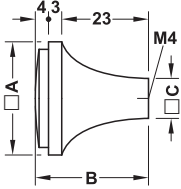

Möbelknöpfe traditionell

Oberfläche/Farbe	Maß A mm	Maß B mm	Maß C mm	Abpackung	Artikel-Nr.
vermessingt	30	30	10,5	1, 20 oder 100	155.02.270
gebürstet	35	30	10,5	1, 20 oder 80	155.02.280
edelstahlfarben	30	30	10,5	1, 20 oder 100	155.02.271
	35	30	10,5	1, 20 oder 80	155.02.281
bronzefarben geölt	30	30	10,5	1, 20 oder 100	155.02.272
gebürstet	35	30	10,5	1, 20 oder 80	155.02.282
vernickelt poliert	30	30	10,5	1, 20 oder 100	155.02.273
	35	30	10,5	1, 20 oder 80	155.02.283

passende Möbelgriffe ▶ MB 1.335 B  
Gewindeschrauben M4 ▶ MB 1.470

DGH-M 2018; HDE-de, 06/18; Maßangaben unverbindlich. Konstruktionsänderungen vorbehalten.



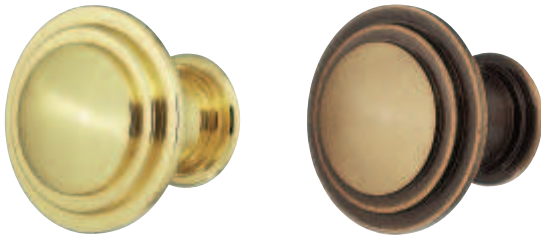

Oberfläche	Maß A mm	Maß B mm	Maß C mm	Artikel-Nr.
poliert	30	22	18	135.07.103
braun durchgerieben	30	22	18	135.06.103

Abpackung: 1 oder 10 Stück

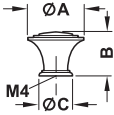

Oberfläche	Artikel-Nr.
poliert	132.07.803
braun durchgerieben	132.07.103

Abpackung: 1 oder 25 Stück

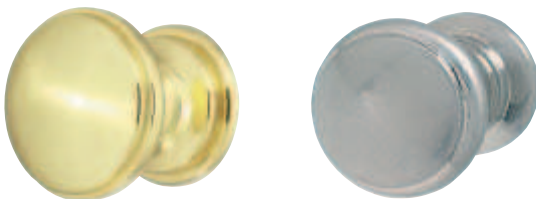
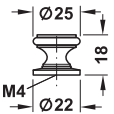

> Werkstoff: Messing

Oberfläche	Maß A mm	Maß B mm	Maß C mm	Artikel-Nr.
poliert	25	22	21	137.32.824
	30	25	24	137.32.833
vernickelt matt	30	25	24	137.96.600

Abpackung: 1 oder 25 Stück

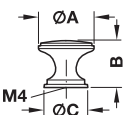

DGH-M 2018, HIDE-de, 06/18; Maßangaben unverbindlich. Konstruktionsänderungen vorbehalten.

Gewindeschrauben M4

► MB 1.470

1



Möbelknöpfe traditionell

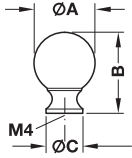

Oberfläche	Maß A mm	Maß B mm	Maß C mm	Artikel-Nr.
verchromt poliert	25	35	15	136.87.226
vernickelt matt	25	35	15	136.87.628
poliert	25	35	15	136.87.824

Abpackung: 1 oder 25 Stück

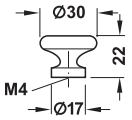

Oberfläche	Artikel-Nr.
poliert	137.60.837

Abpackung: 1 oder 25 Stück

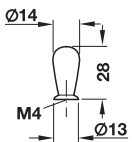
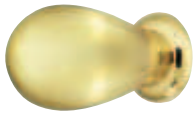

Oberfläche	Artikel-Nr.
poliert	134.56.800

Abpackung: 1 oder 10 Stück

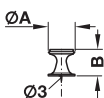

> Oberfläche:	poliert
> Ausführung:	Befestigungsschraube im Lieferumfang enthalten

Maß A mm	Maß B mm	Artikel-Nr.
14	13	137.31.845

Abpackung: 1 oder 25 Stück

Gewindeschrauben M4

► MB 1.470

DGH-M 2018; HDE-de, 06/18; Maßangaben unverbindlich. Konstruktionsänderungen vorbehalten.

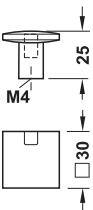
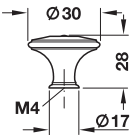
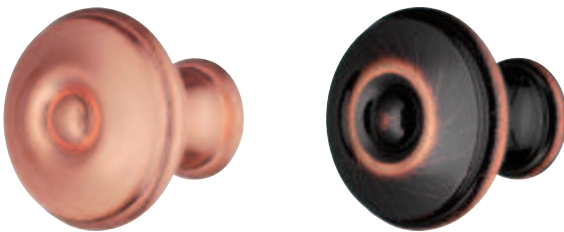

Oberfläche	Artikel-Nr.
verkupfert gebürstet	121.57.131
verkupfert durchgerieben	121.57.141

Abpackung: 1 oder 25 Stück

passender Möbelgriff ▶ MB 1.46

Oberfläche	Artikel-Nr.
braun durchgerieben	131.08.100

Abpackung: 1 oder 25 Stück

passender Möbelgriff ▶ MB 1.337

Gewindeschrauben M4 ▶ MB 1.470

DGH-M 2018, HIDE-de, 06/18; Maßangaben unverbindlich. Konstruktionsänderungen vorbehalten.

1

Möbelknöpfe traditionell

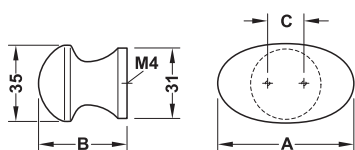

Oberfläche/Farbe	Maß A mm	Maß B mm	Maß C mm	Artikel-Nr.
edelstahlfarben	60	39	16	155.02.020
silberfarben, antik	60	39	16	155.02.021
verzinkt antik	60	39	16	155.02.022

Abpackung: 1, 30 oder 60 Stück

Gewindeschrauben M4

► MB 1.470

DGH-M 2018; HDE-de, 06/18; Maßangaben unverbindlich. Konstruktionsänderungen vorbehalten.



Möbelknöpfe traditionell

Bei diesen Griffen wurden bewusst Gebrauchsspuren eingearbeitet. Dadurch ist jeder Griff ein Unikat.

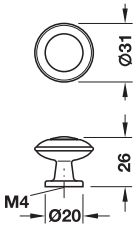

Oberfläche	Artikel-Nr.
eisenfarben, Used Look	134.15.080

Abpackung: 1 oder 25 Stück

passender Möbelgriff ▶ MB 1.333

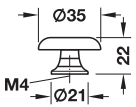

Oberfläche	Artikel-Nr.
verzinkt antik	121.06.928

Abpackung: 1 oder 25 Stück

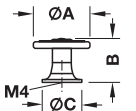

Oberfläche	Maß A mm	Maß B mm	Maß C mm	Artikel-Nr.
braun	30	23	21	134.33.111
durchgerieben	36	26	21	134.33.120
goldfarben	30	23	21	134.33.817
poliert				

Abpackung: 1 oder 25 Stück

Gewindeschrauben M4 ▶ MB 1.470

DGH-M 2018, HIDE-de, 06/18; Maßangaben unverbindlich. Konstruktionsänderungen vorbehalten.

1



Möbelknöpfe traditionell

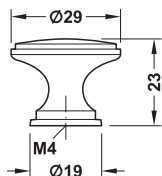

Oberfläche	Artikel-Nr.
verchromt poliert	155.00.100
vernickelt matt	155.00.105
vermessingt antik	155.00.110

Abpackung: 1 oder 25 Stück

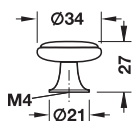

Oberfläche/Farbe	Artikel-Nr.
Knopf: verchromt poliert, Einlage: weiß	134.07.219
Knopf: verchromt poliert, Einlage: verchromt matt	134.07.228
Knopf: goldfarben poliert, Einlage: weiß	134.07.817

Abpackung: 1 oder 25 Stück

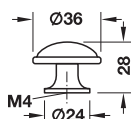

Oberfläche	Artikel-Nr.
verchromt poliert	134.09.231
vernickelt matt	134.09.633
goldfarben poliert	134.09.839

Abpackung: 1 oder 25 Stück

Gewindeschrauben M4

► MB 1.470

DGH-M 2018; HDE-de, 06/18; Maßangaben unverbindlich. Konstruktionsänderungen vorbehalten.

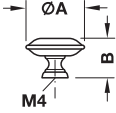

> Oberfläche: braun durchgerieben

Maß A mm	Maß B mm	Artikel-Nr.
26	19	125.73.112
31	21	125.73.113

Abpackung: 1 oder 50 Stück

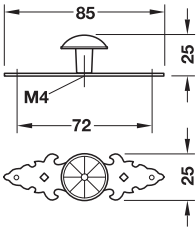

Oberfläche	Artikel-Nr.
braun durchgerieben	121.52.117

Abpackung: 1 oder 25 Stück

Rundkopf-Metallstift Ø 1,6 mm, vernickelt ▶ MB 1.471

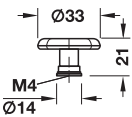

Oberfläche	Artikel-Nr.
braun durchgerieben	121.63.138

Abpackung: 1 oder 25 Stück

DGH-M 2018, HIDE-de, 06/18; Maßangaben unverbindlich. Konstruktionsänderungen vorbehalten.

Gewindeschrauben M4

▶ MB 1.470

Möbelknöpfe traditionell





1



Anwendungsbeispiel

Möbelknöpfe traditionell

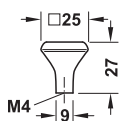

Platte

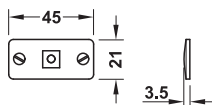

Muschelgriff

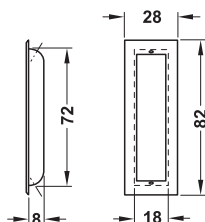

Oberfläche/Farbe	Artikel-Nr.
braun durchgerieben	131.31.100

Abpackung: 1 oder 25 Stück

Oberfläche	Artikel-Nr.
braun durchgerieben	131.31.150

Abpackung: 1 oder 25 Stück

Gewindeschrauben M4	► MB 1.470
---------------------	------------

> Werkstoff:	Stahl
--------------	-------

Oberfläche	Artikel-Nr.
braun durchgerieben	152.15.120

Abpackung: 1 oder 25 Stück

Rundkopf-Metallstifte Ø 1,6 mm	► MB 1.471
--------------------------------	------------

DGH-M 2018; HDE-de, 06/18; Maßangaben unverbindlich. Konstruktionsänderungen vorbehalten.

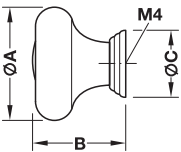

> Werkstoff: Knopf: Porzellan,  
Sockel und Einlage: Zinkdruckguss

Oberfläche/ Farbe	Maß A mm	Maß B mm	Maß C mm	Ab- packung Stück	Artikel-Nr.
Knopf: weiß, Sockel und Einlage: verzinkt antik	30	25	18	1, 100 oder 400	155.02.130
	37	30	22	1 oder 25	125.74.792

passende Möbelgriffe ▶ MB 1.338

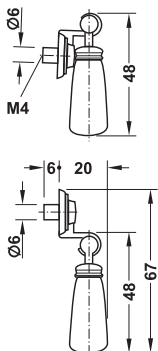

> Werkstoff: Griff: Porzellan,  
Sockel: Zinkdruckguss

Oberfläche/Farbe	Artikel-Nr.
Griff: weiß, Sockel: verzinkt antik	155.02.145

Abpackung: 1 Stück

passende Möbelgriffe ▶ MB 1.338

Gewindeschrauben M4 ▶ MB 1.470

DGH-M 2018, HIDE-de, 06/18; Maßangaben unverbindlich. Konstruktionsänderungen vorbehalten.

1

Möbelknöpfe traditionell

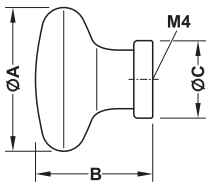

> Werkstoff: Knopf: Porzellan,  
Sockel: Zinkdruckguss

Oberfläche/Farbe	Maß A mm	Maß B mm	Maß C mm	Artikel-Nr.
Knopf: weiß, Sockel: poliert	30 37	25 30	18 21	155.02.135 155.02.140
Knopf: weiß, Sockel: verzinkt antik	30 37	25 30	18 21	155.02.136 155.02.141

Abpackung: 1 Stück

passende Möbelgriffe ► MB 1.338  
Gewindeschrauben M4 ► MB 1.470

DGH-M 2018; HDE-de, 06/18; Maßangaben unverbindlich. Konstruktionsänderungen vorbehalten.

**DIESE SEITE WURDE BEWUSST  
LEER GELASSEN**

**INTENTIONAL BLANK PAGE**

1



Möbelknöpfe traditionell

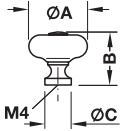

- > Werkstoff: Knopf: Porzellan, Sockel und Einlage: Zinkdruckguss
- > Oberfläche/Farbe: Knopf: weiß, Sockel und Einlage: verzinkt antik

Maß A mm	Maß B mm	Maß C mm	Artikel-Nr.
30	30	18	130.51.764
35	30	18	130.51.791

Abpackung: 1 oder 50 Stück

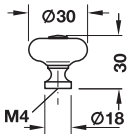

- > Werkstoff: Knopf: Porzellan, Sockel und Einlage: Zinkdruckguss

Oberfläche/Farbe	Artikel-Nr.
Knopf: weiß, Sockel und Einlage: braun durchgerieben	130.51.755

Abpackung: 1 oder 50 Stück

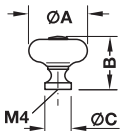
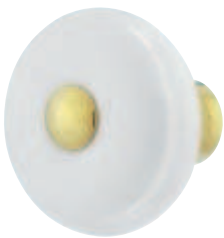

- > Werkstoff: Knopf: Porzellan, Sockel und Einlage: Messing
- > Oberfläche/Farbe: Knopf: weiß, Sockel und Einlage: poliert

Maß A mm	Maß B mm	Maß C mm	Artikel-Nr.
32	28	14	130.51.745

Abpackung: 1 oder 50 Stück

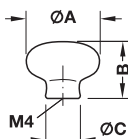

- > Farbe: weiß

Maß A mm	Maß B mm	Maß C mm	Artikel-Nr.
32	25	17	130.08.707
38	29	20	130.08.708

Abpackung: 1 oder 50 Stück

Gewindeschrauben M4

► MB 1.470

DGH-M 2018; HDE-de, 06/18; Maßangaben unverbindlich. Konstruktionsänderungen vorbehalten.

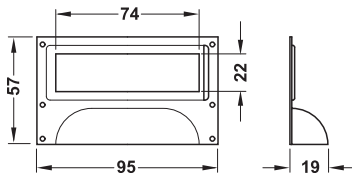

> Werkstoff: Stahl  
> Oberfläche: vernickelt

Etikettengröße mm	Artikel-Nr.
80 x 26	168.09.704

Abpackung: 1 oder 50 Stück

Rundkopf-Metallstifte Ø 1,6 mm

► MB 1.471

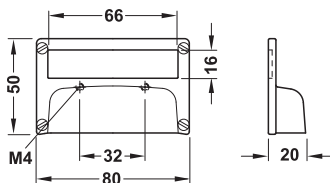

> Werkstoff: Zinkdruckguss  
> Oberfläche: vernickelt poliert

Etikettengröße mm	Artikel-Nr.
75 x 18	168.08.700

Abpackung: 1 oder 25 Stück

Gewindeschrauben M4

► MB 1.470

DGH-M 2018, HDE-de, 06/18; Maßangaben unverbindlich. Konstruktionsänderungen vorbehalten.

Bootslook-Beschläge, Beschriftungsrahmen, Applikationen, Schlüsselschilder

1

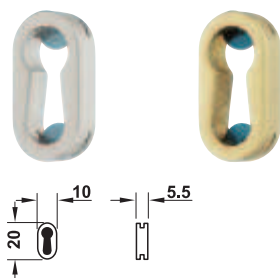

> Werkstoff: Messing  
> Montage: Plättchenbefestigung

Oberfläche	Artikel-Nr.
vernickelt matt	185.10.621
matt	185.10.521

Abpackung: 1 oder 100 Stück

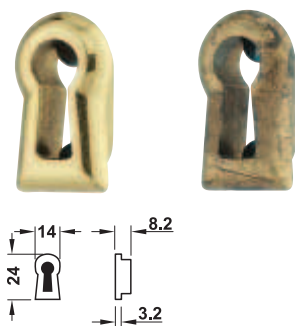

> Werkstoff: Messing  
> Montage: Plättchenbefestigung

Oberfläche	Artikel-Nr.
poliert	185.30.830
braun durchgerieben	185.30.130

Abpackung: 1 oder 100 Stück

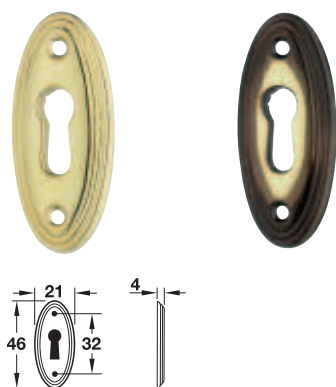

> Werkstoff: Messing

Oberfläche	Artikel-Nr.
poliert	118.20.885
braun durchgerieben	118.20.189

Abpackung: 1 oder 25 Stück

Holzschrauben Senkkopf Ø 2 mm ▶ MB 1.471

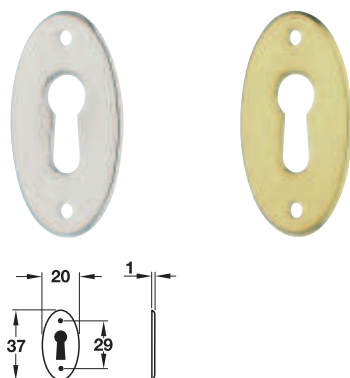

> Werkstoff: Messing

Oberfläche	Artikel-Nr.
vernickelt poliert	174.01.750
poliert	174.01.850

Abpackung: 1 oder 25 Stück

Holzschrauben Senkkopf Ø 2 mm ▶ MB 1.471

Bootslook-Beschläge, Beschriftungsrahmen, Applikationen, Schlüsselschilder



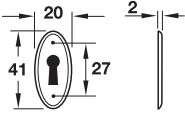

> Werkstoff:	Stahl
--------------	-------

Oberfläche	Artikel-Nr.
vernickelt	176.08.710

Abpackung: 1 oder 25 Stück

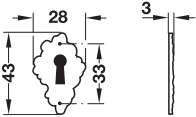

Oberfläche	Artikel-Nr.
braun durchgerieben	119.08.106

Abpackung: 1 oder 25 Stück

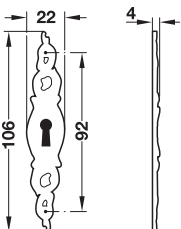

Oberfläche	Artikel-Nr.
braun durchgerieben	119.06.120

Abpackung: 1 oder 25 Stück

DGH-M 2018, HIDE-de, 06/18; Maßangaben unverbindlich. Konstruktionsänderungen vorbehalten.

Rundkopf-Metallstifte Ø 1,6 mm	► MB 1.471
--------------------------------	------------

1



Bootslook-Beschläge, Beschriftungsrahmen, Applikationen, Schlüsselschilder

# 1

# HÄFELE

LUXURIÖS.  
BRINGT GLANZ IN DEN ALLTAG.





Die Griffe sind mit edlen Kristallen bestückt, daher nur mit einem weichen Tuch reinigen.



1

Möbelgriffe luxuriös

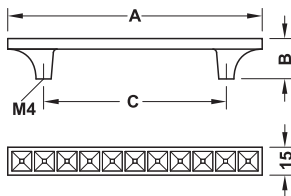

> Werkstoff: Griff: Zinkdruckguss, Einlage: Kristalle

Oberfläche/Farbe	Maß A mm	Maß B mm	Maß C mm	Abpackung Stück	Artikel-Nr.
Griff:	100	21	64	1 oder 25	103.29.710
vernickelt	136	21	96	1 oder 25	103.29.711
poliert, Einlage: transparent	173	21	128	1 oder 10	103.29.712

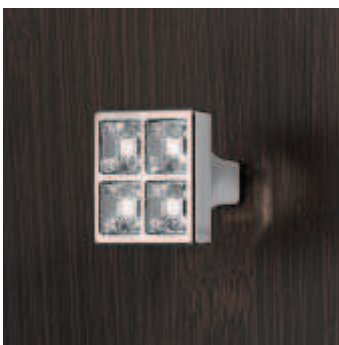

Dieses Produkt ist mit edlen Kristallen bestückt, daher nur mit einem weichen Tuch reinigen.

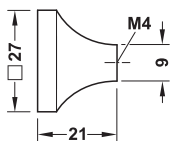

> Werkstoff: Knopf: Zinkdruckguss, Einlage: Kristalle

Oberfläche	Artikel-Nr.
Knopf: vernickelt poliert Einlage: transparent	132.19.710

Abpackung: 1 oder 25 Stück

Gewindeschrauben M4

► MB 1.470

1

Möbelgriffe luxuriös



Die Griffe sind mit edlen Kristallen bestückt, daher nur mit einem weichen Tuch reinigen.

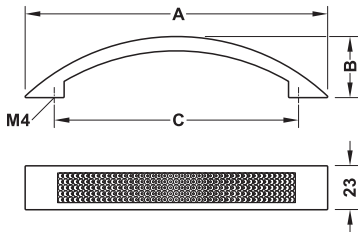

> Werkstoff: Griff: Zinkdruckguss, Einlage: Kristalle

Oberfläche/Farbe	Maß A mm	Maß B mm	Maß C mm	Artikel-Nr.
Griff: verchromt poliert, Einlage: transparent	160	31	128	155.02.105

Abpackung: 1 Stück

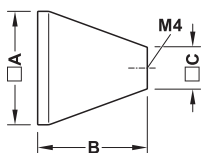
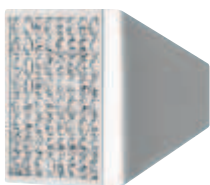

Die Griffe sind mit edlen Kristallen bestückt, daher nur mit einem weichen Tuch reinigen.



> Werkstoff: Griff: Zinkdruckguss, Einlage: Kristalle

Oberfläche/Farbe	Maß A mm	Maß B mm	Maß C mm	Artikel-Nr.
Knopf: verchromt poliert, Einlage: transparent	30	29	11	155.02.035

Abpackung: 1 Stück

Gewindeschrauben M4

► MB 1.470

DGH-M 2018; HDE-de, 06/18; Maßangaben unverbindlich. Konstruktionsänderungen vorbehalten.

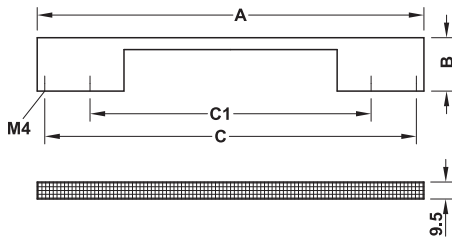
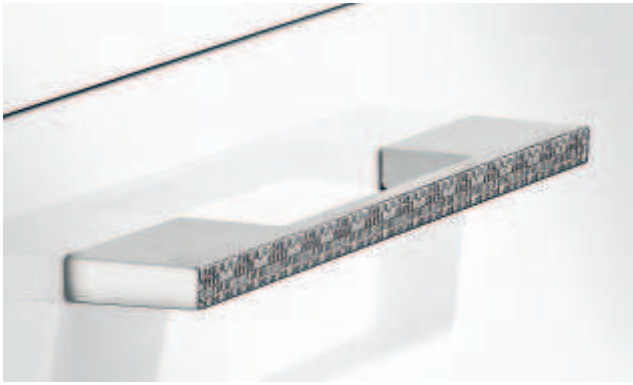

Oberfläche/Farbe	Maß A mm	Maß B mm	Maß C mm	Maß C1 mm	Artikel-Nr.
verchromt poliert	204	28	192	160	110.22.243

Abpackung: 1 oder 10 Stück

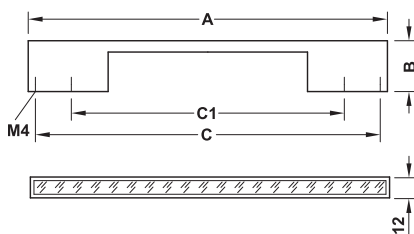

Oberfläche/Farbe	Maß A mm	Maß B mm	Maß C mm	Maß C1 mm	Artikel-Nr.
Griff: verchromt poliert, Einlage: Glitzereinsatz	198	26	192	160	110.22.253

Abpackung: 1 oder 10 Stück

- passende Möbelknöpfe ▶ MB 1.357 C
- Gewindeschrauben M4 ▶ MB 1.470

DGH-M 2018, HDE-de, 06/18; Maßangaben unverbindlich. Konstruktionsänderungen vorbehalten.

Möbelgriffe luxuriös



1

Möbelknöpfe luxuriös

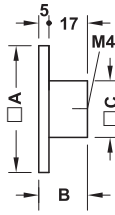

> Werkstoff: Knopf: Zinkdruckguss,  
Einlage: Glitzereinsatz

Oberfläche/Farbe	Maß A mm	Maß B mm	Maß C mm	Artikel-Nr.
Knopf: verchromt poliert	57	22	24	132.15.220

Abpackung: 1 oder 10 Stück

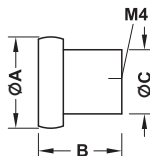

> Werkstoff: Knopf: Zinkdruckguss,  
Einlage: Glitzereinsatz

Oberfläche/Farbe	Maß A mm	Maß B mm	Maß C mm	Artikel-Nr.
Knopf: verchromt poliert	24	22	17	132.15.210

Abpackung: 1 oder 10 Stück

passender Möbelgriff ▶ MB 1.357 B

Gewindeschrauben M4 ▶ MB 1.470

DGH-M 2018; HDE-de, 06/18; Maßangaben unverbindlich. Konstruktionsänderungen vorbehalten.

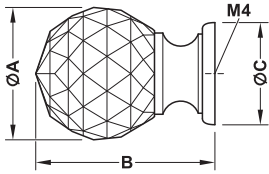
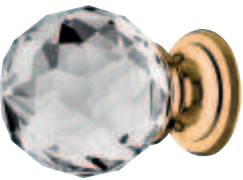

> Werkstoff: Knopf: Glas,  
Basis: Zinkdruckguss

Oberfläche/Farbe	Maß A mm	Maß B mm	Maß C mm	Artikel-Nr.
Knopf: transparent, Basis: vermessingt poliert	25	35	20	155.02.091
	30	42	25	155.02.096
	35	46	26,5	155.02.101

Abpackung: 1 Stück

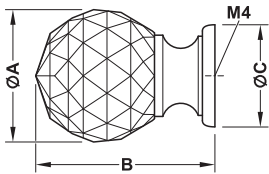

> Werkstoff: Knopf: Glas,  
Basis: Zinkdruckguss

Oberfläche/Farbe	Maß A mm	Maß B mm	Maß C mm	Artikel-Nr.
Knopf: transparent, Basis: verchromt poliert	25	35	20	155.02.092
	30	42	25	155.02.097
	35	46	26,5	155.02.102

Abpackung: 1 Stück



1



Möbelgriffe luxuriös

**Modell H1575**

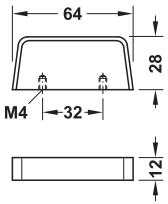
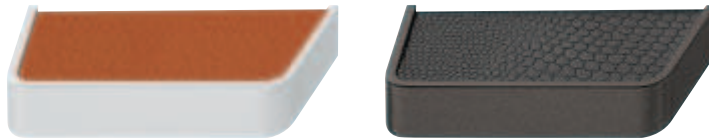

> Werkstoff: Griff: Zinkdruckguss,  
 Einlage: Lederimitat

Oberfläche	Artikel-Nr.
Griff: weiß lackiert Einlage: cognacfarben	103.83.761
Griff: titanfarben lackiert Einlage: schwarz/Kroko-Optik	103.83.061

Abpackung: 1 oder 50 Stück

Gewindeschrauben M4

► MB 1.470

DGH-M 2018; HDE-de, 06/18; Maßangaben unverbindlich. Konstruktionsänderungen vorbehalten.

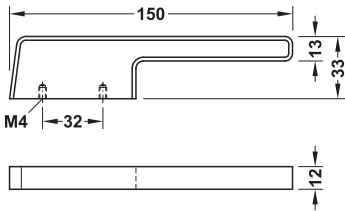

> Werkstoff: Griff: Zinkdruckguss,  
 Einlage: Lederimitat

Oberfläche	Artikel-Nr.
Griff: weiß lackiert Einlage: cognacfarben	103.83.751
Griff: titanfarben lackiert Einlage: schwarz/Kroko-Optik	103.83.051

Abpackung: 1 oder 25 Stück

DGH-M 2018, HIDE-de, 06/18; Maßangaben unverbindlich. Konstruktionsänderungen vorbehalten.

Gewindeschrauben M4

► MB 1.470

1

HÄFELE

GARDEROBEN,  
GARDEROBENHAKEN,  
KLEIDERBÜGEL





## Edelstahl – Trend



▶ MB 1.368



▶ MB 1.368



▶ MB 1.411

## Edelstahl – Zeitlos



▶ MB 1.374



▶ MB 1.375



▶ MB 1.376



▶ MB 1.377



▶ MB 1.379 **Topco**



▶ MB 1.383 **Topco**



▶ MB 1.385



▶ MB 1.387 **Topco**



▶ MB 1.389 **Topco**



▶ MB 1.390 **Topco**



▶ MB 1.391 **Topco**



▶ MB 1.392 **Topco**



▶ MB 1.393 **Topco**



▶ MB 1.394



▶ MB 1.394



▶ MB 1.395

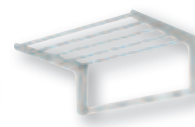

▶ MB 1.399 **Topco**

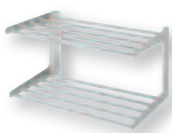

▶ MB 1.399 **Topco**



▶ MB 1.401 **Topco**

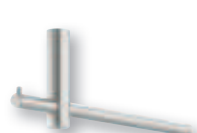

▶ MB 1.403



▶ MB 1.396



▶ MB 1.397



▶ MB 1.402



▶ MB 1.402



▶ MB 1.404

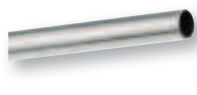

▶ MB 1.405



▶ MB 1.405



▶ MB 1.381 **Topco**



▶ MB 1.397



▶ MB 1.411



▶ MB 1.419



▶ MB 1.419



▶ MB 1.419



▶ MB 1.419



▶ MB 1.419



▶ MB 1.419



▶ MB 1.420



▶ MB 1.421



▶ MB 1.421



▶ MB 1.424

DGH-M 2018, HDE-de, 06/18; Maßangaben unverbindlich. Konstruktionsänderungen vorbehalten.



## Edelstahl – Zeitlos

1

Garderoben, Garderobenhaken



▶ MB 1.424



▶ MB 1.412 **Topco**



▶ MB 1.412



▶ MB 1.412 **Topco**



▶ MB 1.412



▶ MB 1.413



▶ MB 1.413



▶ MB 1.414



▶ MB 1.414



▶ MB 1.415



▶ MB 1.415



▶ MB 1.416



▶ MB 1.416



▶ MB 1.416



▶ MB 1.416



▶ MB 1.417



▶ MB 1.417



▶ MB 1.417



▶ MB 1.417



▶ MB 1.418



▶ MB 1.418 **Topco**

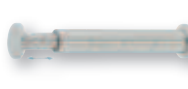

▶ MB 1.418 **Topco**



▶ MB 1.421



▶ MB 1.423

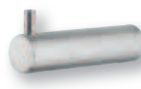

▶ MB 1.421



▶ MB 1.423



▶ MB 1.426



▶ MB 1.426



▶ MB 1.422



▶ MB 1.422



▶ MB 1.422



▶ MB 1.423



▶ MB 1.422



▶ MB 1.427



▶ MB 1.427



▶ MB 1.428



▶ MB 1.428



▶ MB 1.425



▶ MB 1.425



▶ MB 1.429



▶ MB 1.430



▶ MB 1.430



▶ MB 1.431



▶ MB 1.431

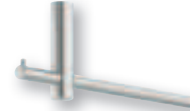

▶ MB 1.403

DGH-M 2018; HDE-de, 06/18; Maßangaben unverbindlich. Konstruktionsänderungen vorbehalten.



Aluminium – Zeitlos



Holz und Metall – Trend



Stahl – Trend

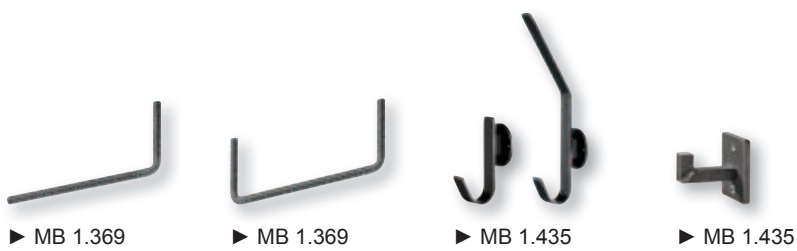

Stahl – Zeitlos

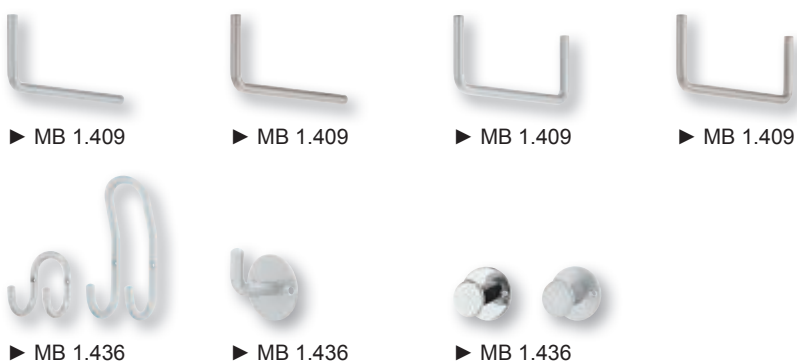

DGH-M 2018, HDE-de, 06/18; Maßangaben unverbindlich. Konstruktionsänderungen vorbehalten.





1

Garderoben, Garderobenhaken

Messing – Trend



▶ MB 1.437



▶ MB 1.439

Messing – Zeitlos



▶ MB 1.438



▶ MB 1.438



▶ MB 1.438



▶ MB 1.440



▶ MB 1.440



▶ MB 1.438



▶ MB 1.438



▶ MB 1.438



▶ MB 1.440

Zinkdruckguss – Trend



▶ MB 1.443



▶ MB 1.443



▶ MB 1.443



▶ MB 1.444



▶ MB 1.444



▶ MB 1.445



▶ MB 1.445



▶ MB 1.445



▶ MB 1.447



▶ MB 1.450



▶ MB 1.450



▶ MB 1.451



▶ MB 1.451

DGH-M 2018; HDE-de, 06/18; Maßangaben unverbindlich. Konstruktionsänderungen vorbehalten.





Zinkdruckguss – Zeitlos



▶ MB 1.441



▶ MB 1.441



▶ MB 1.441



▶ MB 1.441



▶ MB 1.441



▶ MB 1.441



▶ MB 1.446



▶ MB 1.446



▶ MB 1.446



▶ MB 1.446



▶ MB 1.446



▶ MB 1.446



▶ MB 1.447



▶ MB 1.447



▶ MB 1.442



▶ MB 1.442

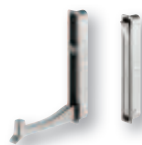

▶ MB 1.448



▶ MB 1.448

Zinkdruckguss – Traditionell



▶ MB 1.449



▶ MB 1.449



▶ MB 1.449



▶ MB 1.449



▶ MB 1.449



▶ MB 1.449



▶ MB 1.449



▶ MB 1.449

DGH-M 2018, HDE-de, 06/18; Maßangaben unverbindlich. Konstruktionsänderungen vorbehalten.



1

## Kunststoff und Metall – Trend



▶ MB 1.410



▶ MB 1.410



▶ MB 1.410

Garderoben, Garderobenhaken

## Kunststoff – Trend



▶ MB 1.453



▶ MB 1.453



▶ MB 1.453



▶ MB 1.453



▶ MB 1.453

## Kunststoff – Zeitlos



▶ MB 1.452



▶ MB 1.454



▶ MB 1.454



▶ MB 1.456



▶ MB 1.455



▶ MB 1.455



▶ MB 1.456



▶ MB 1.455



Edelstahl – Zeitlos

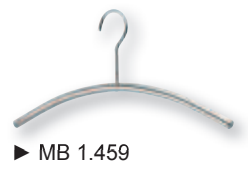
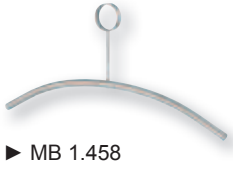
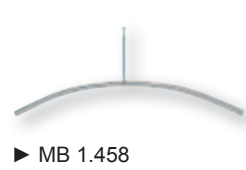

Aluminium – Zeitlos

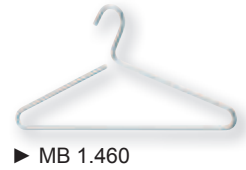

Stahl – Zeitlos

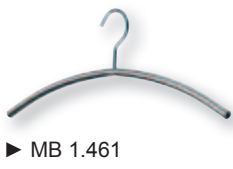

Holz – Trend



Holz – Zeitlos



Kunststoff – Zeitlos



DGH-M 2018, HDE-de, 06/18; Maßangaben unverbindlich. Konstruktionsänderungen vorbehalten.

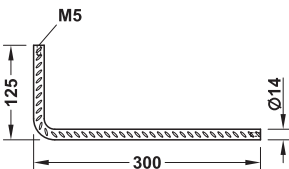
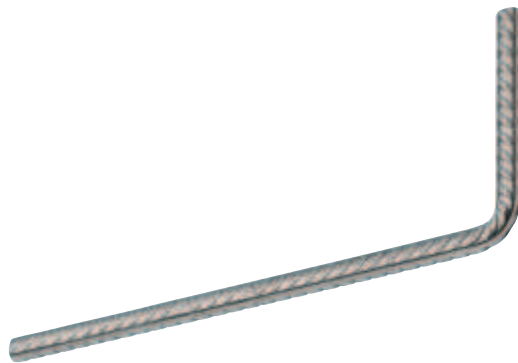

- > Werkstoff: Edelstahl, Güte 1.4571
- > Oberfläche: matt gebürstet
- > Einsatzbereich: Montage unter dem Fachboden und an der Rückwand

Länge mm	Höhe mm	Bügel-Durchmesser mm	Artikel-Nr.
300	125	14	843.68.080

Abpackung: 1 Stück

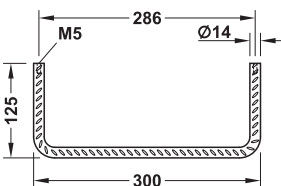
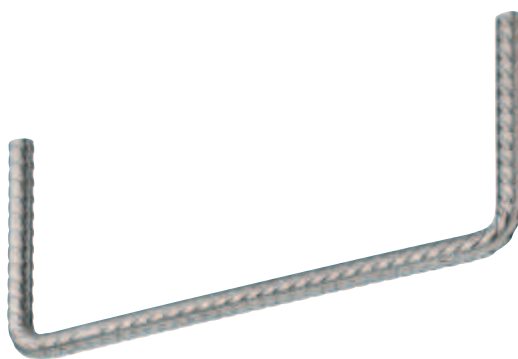

- > Werkstoff: Edelstahl, Güte 1.4571
- > Oberfläche: matt gebürstet
- > Einsatzbereich: Montage unter dem Fachboden

Länge mm	Höhe mm	Bügel-Durchmesser mm	Artikel-Nr.
300	125	14	843.68.090

Abpackung: 1 Stück

Möbelknopf Edelstahl in Baustahl-Optik	▶ MB 1.120
Bügelgriff Edelstahl in Baustahl-Optik	▶ MB 1.42
Bogengriff Edelstahl in Baustahl-Optik	▶ MB 1.36
Garderobenhaken Edelstahl in Baustahl-Optik	▶ MB 1.411
Garderobenhaken Edelstahl in Baustahl-Optik	▶ MB 1.368
Gewindeschrauben Senkkopf M5	▶ MB 1.471

Garderobenbügel



1

Garderoben

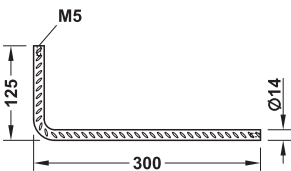
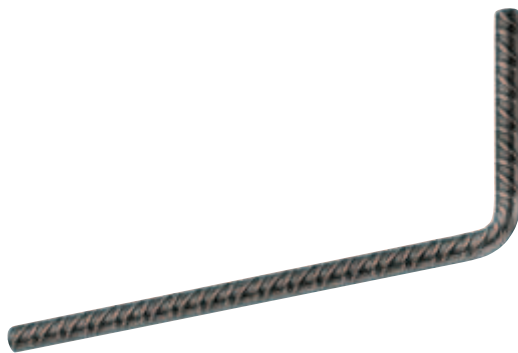

- > Werkstoff: Baustahl
- > Oberfläche: roh lackiert, Used Look
- > Einsatzbereich: Montage unter dem Fachboden und an der Rückwand

Länge mm	Höhe mm	Bügel- Durchmesser mm	Artikel-Nr.
300	125	14	843.68.380

Abpackung: 1 Stück

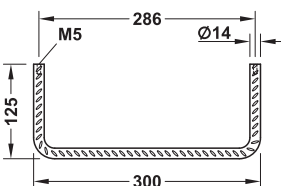

- > Werkstoff: Baustahl
- > Oberfläche: roh lackiert, Used Look
- > Einsatzbereich: Montage unter dem Fachboden

Länge mm	Höhe mm	Bügel- Durchmesser mm	Artikel-Nr.
300	125	14	843.68.390

Abpackung: 1 Stück

DGH-M 2018, HIDE-de, 06/18; Maßangaben unverbindlich. Konstruktionsänderungen vorbehalten.

Möbelknopf Stahl in Baustahl-Optik	► MB 1.120
Bügelgriff Stahl in Baustahl-Optik	► MB 1.42
Bogengriff Stahl in Baustahl-Optik	► MB 1.36
Garderobenhaken Stahl in Baustahl-Optik	► MB 1.411
Gewindeschrauben Senkkopf M5	► MB 1.471



→ Beschlagsatz für Holz- und Glasplatten, mit ausziehbarer Teleskopstange



Gestaltungsbeispiel mit Glasplatte



Gestaltungsbeispiel mit Holzplatte

Mit diesem Garderobenbeschlagsatz lässt sich für alle Flur- und Nischenbereiche eine platzsparende Garderobe gestalten. Die ausziehbare Teleskopstange schafft zusätzliche Aufhängemöglichkeiten.

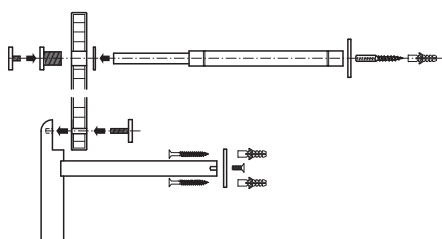
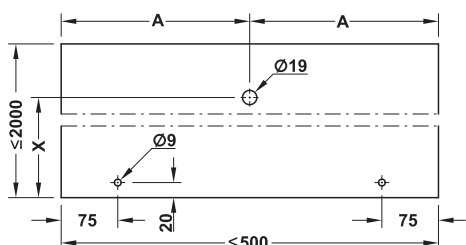

Montage mit Holzplatte

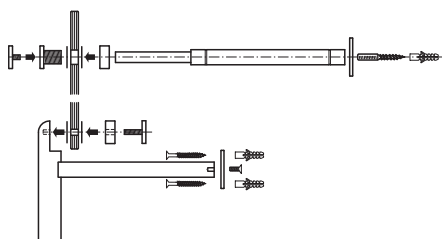

Montage mit Glasplatte

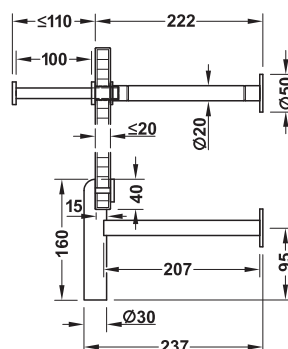

- > Werkstoff: Edelstahl, Güte 1.4305
- > Montage: Wandmontage, Platten zum Schrauben
- > Einsatzbereich: für Glasplatten 8–10 mm Dicke und Holzplatten max. 20 mm Dicke
- > Befestigungsmaterial im Lieferumfang enthalten (Spanplattenschrauben  $\varnothing 4,0 \times 50$  mm,  $6,0 \times 50$  mm und Dübel)

Oberfläche	Artikel-Nr.
matt gebürstet	844.16.107

Abpackung: 1 Stück

**Hinweis**

Plattenmaterial im Lieferumfang nicht enthalten.

→ Beschlagsatz, drehbar, für Holzplatten



Gestaltungsbeispiel mit Spiegel

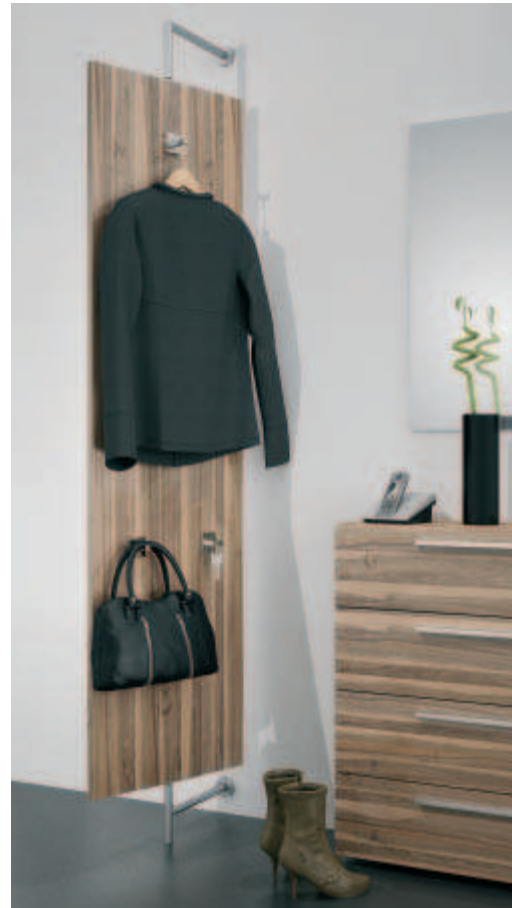

Gestaltungsbeispiel mit Haken

Mit diesem Garderobenbeschlagsatz lässt sich für alle Flur- und Nischenbereiche eine platzsparende, drehbare Garderobe gestalten. Dadurch können wahlweise auf der Rückseite zusätzliche Aufhängemöglichkeiten angebracht werden.



DGH-M 2018, HIDE-de, 06/18; Maßangaben unverbindlich. Konstruktionsänderungen vorbehalten.

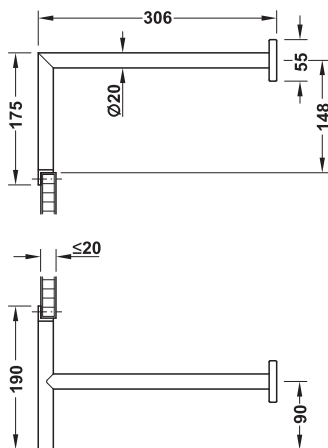

Montage an die Wand

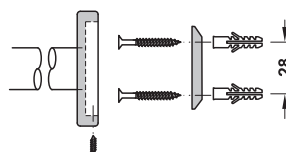

Montage Holzplatte

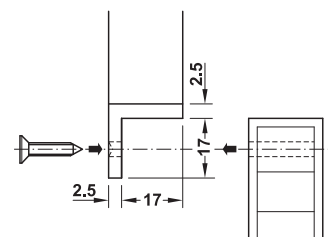

- > Werkstoff: Edelstahl, Güte 1.4305
- > Montage: Wandmontage, Platten zum Schrauben
- > Einsatzbereich: für Holzplatten max. 20 mm Dicke
- > Befestigungsmaterial im Lieferumfang enthalten (Spanplattenschrauben Ø 4,0 x 45 mm und Dübel)

Oberfläche	Artikel-Nr.
matt gebürstet	844.16.100

Abpackung: 1 Stück

**Hinweis**

Plattenmaterial (max. 2.000 x 500 mm) im Lieferumfang nicht enthalten.

Spanplattenschrauben Hospa Senkkopf Ø 3,5 mm ▶ MB 1.470





Mit diesem Garderobenbeschlagsatz lassen sich raffinierte Garderobenlösungen gestalten. Beispielsweise können auf der Rückseite zusätzliche Aufhängemöglichkeiten für Schlüssel angebracht werden.



Gestaltungsbeispiel mit Spiegel und Haken

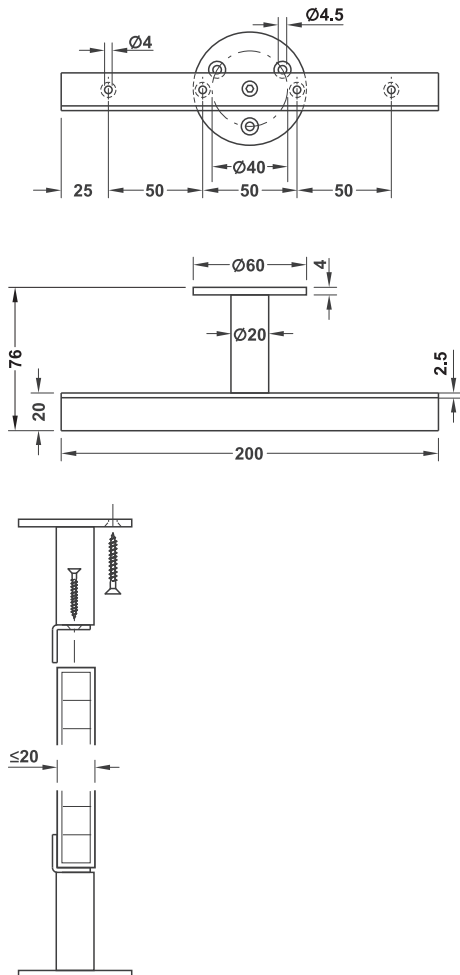

- > Werkstoff: Edelstahl, Güte 1.4305
- > Montage: zwischen Ober- und Unterboden, Platte zum Schrauben
- > Einsatzbereich: für Holzplatten, max. 2000 x 500 x 20 mm
- > Tragkraft: max. 50 kg

Oberfläche	Artikel-Nr.
matt gebürstet	844.16.090

Abpackung: 1 Garnitur

**Hinweis**

Plattenmaterial im Lieferumfang nicht enthalten.

Spanplattenschrauben Hospa Senkkopf Ø 4 mm ► MB 1.470

DGH-M 2018; HDE-de, 06/18; Maßangaben unverbindlich. Konstruktionsänderungen vorbehalten.

→ Beschlagsatz, 360° drehbar, für Korpusse

1



Gestaltungsbeispiel mit Spiegel auf der Vorderseite



Gestaltungsbeispiel mit Schuhfach auf der Rückseite

Garderoben

Mit diesem Garderobenbeschlagsatz können in Wohn-, Bad- oder Flurbereichen dekorative wie auch funktionelle Stauräume geschaffen werden.

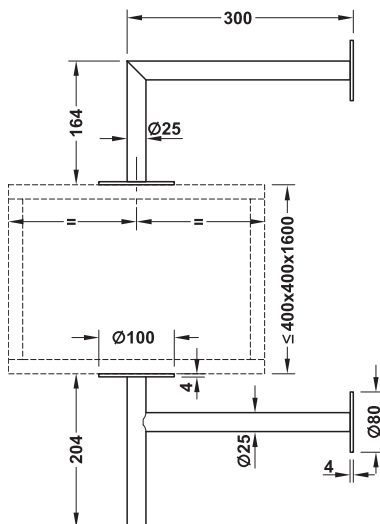

- > Werkstoff: Edelstahl, Güte 1.4305
- > Montage: Wandmontage, zum Schrauben
- > Einsatzbereich: für Korpusse, max. 400 x 400 x 1.600 mm (BxTxH)
- > Tragkraft: 60 kg (inkl. Korpus)
- > Befestigungsmaterial für die Wandmontage im Lieferumfang enthalten

Oberfläche	Artikel-Nr.
matt gebürstet	844.16.110

Abpackung: 1 Stück

**Hinweis**

Plattenmaterial im Lieferumfang nicht enthalten.

DGH-M 2018, HIDE-de, 06/18; Maßangaben unverbindlich. Konstruktionsänderungen vorbehalten.

1

Garderoben

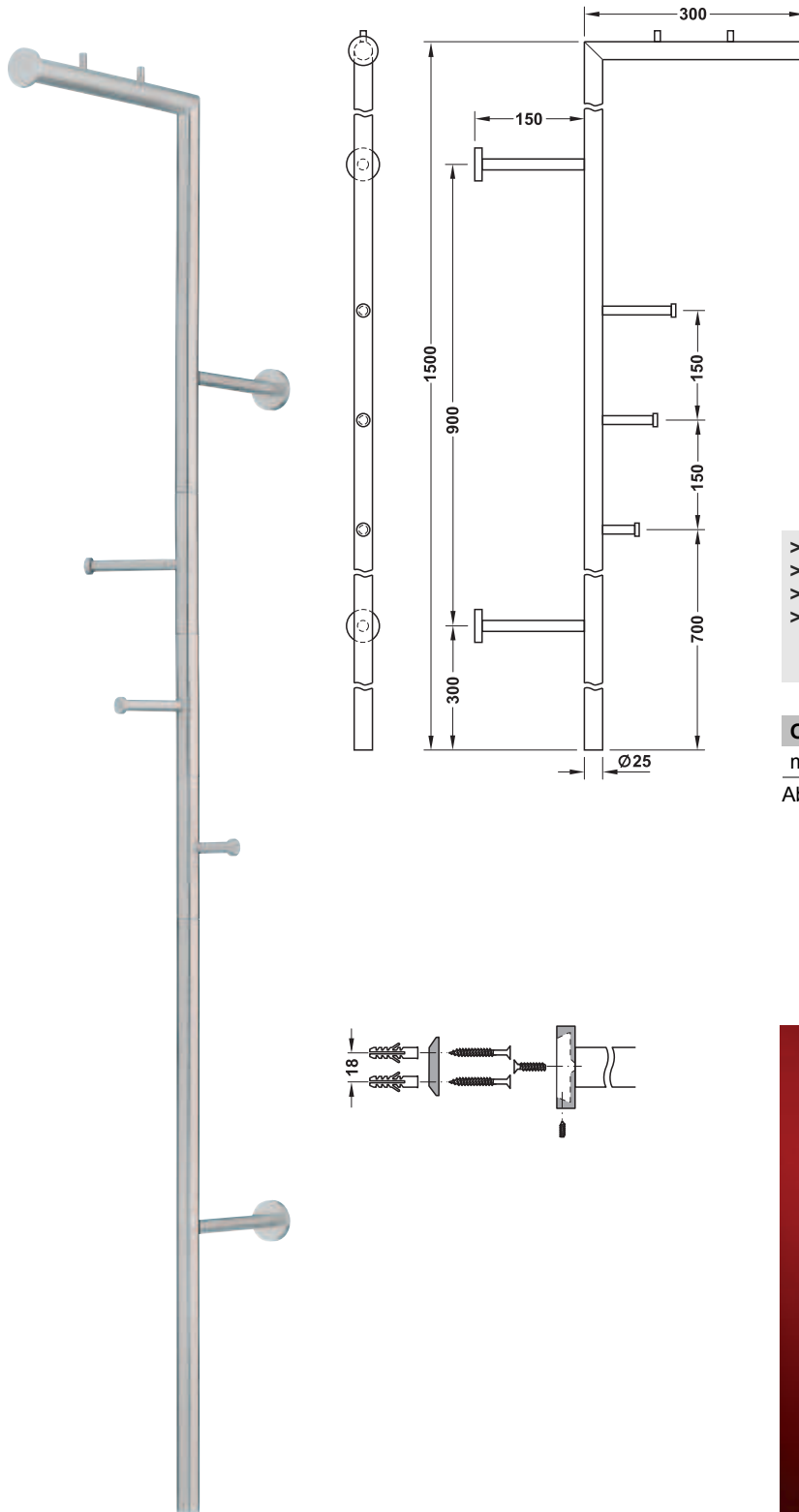

- > Werkstoff: Edelstahl, Güte 1.4305
- > Ausführung: mit drei drehbaren Haken
- > Montage: für Wandmontage
- > Befestigungsmaterial im Lieferumfang enthalten (Spanplattenschrauben  $\text{Ø} 4,0 \times 45 \text{ mm}$  und Dübel)

Oberfläche	Artikel-Nr.
matt gebürstet	844.17.010

Abpackung: 1 Stück



DGH-M 2018; HDE-de, 06/18; Maßangaben unverbindlich. Konstruktionsänderungen vorbehalten.

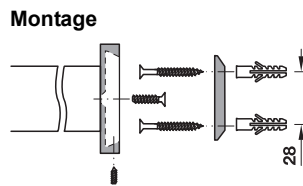
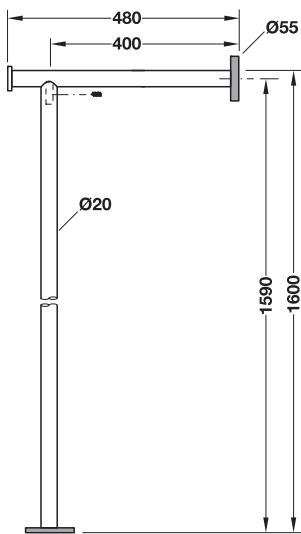
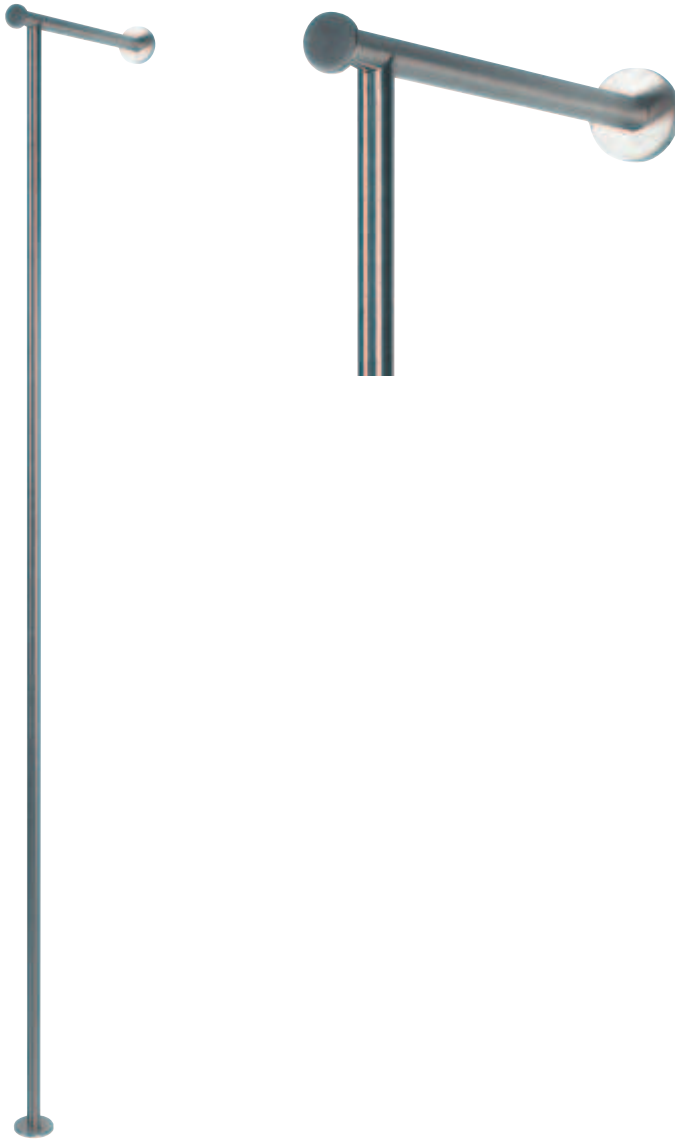

- > Werkstoff: Edelstahl, Güte 1.4305
- > Montage: zum Schrauben an die Wand, zum Stellen oder Kleben auf den Boden
- > Befestigungsmaterial im Lieferumfang enthalten (Spanplattenschrauben Ø 4,0 x 45 mm und Dübel)

Oberfläche	Artikel-Nr.
matt gebürstet	844.17.000

Abpackung: 1 Stück

DGH-M 2018, HIDE-de, 06/18; Maßangaben unverbindlich. Konstruktionsänderungen vorbehalten.

1

Garderoben

Wandgarderobe mit ausziehbarer Teleskopstange

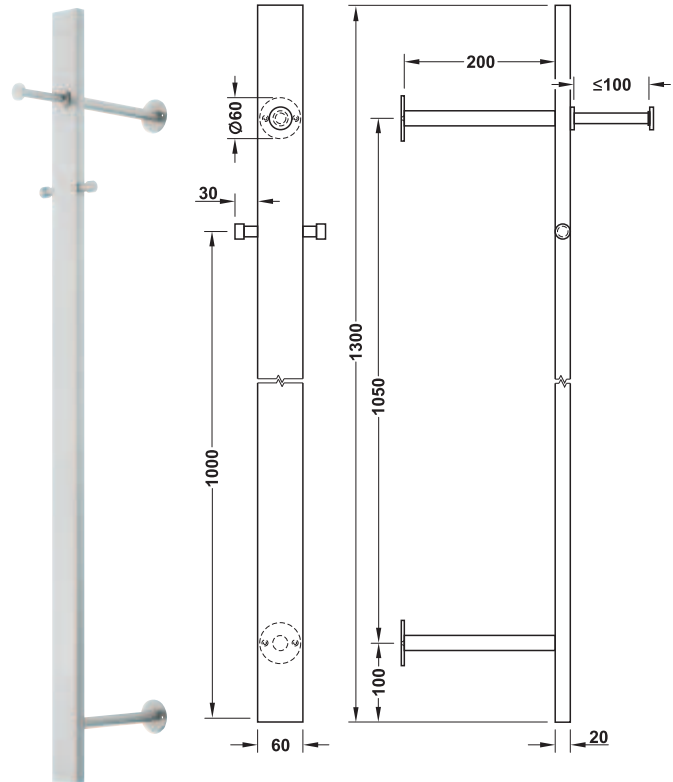

Montage

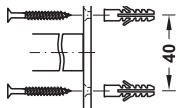

- > Werkstoff: Edelstahl, Güte 1.4301
- > Ausführung: mit 2 feststehenden Haken und einer ausziehbarer Teleskopstange
- > Montage: für Wandmontage
- > Befestigungsmaterial im Lieferumfang enthalten (Spanplattenschrauben  $\varnothing$  3,5 x 40 mm)

Oberfläche	Artikel-Nr.
matt gebürstet	844.17.020

Abpackung: 1 Stück

DGH-M 2018; HDE-de, 06/18; Maßangaben unverbindlich. Konstruktionsänderungen vorbehalten.

Wandgarderobe mit 6 feststehenden Haken

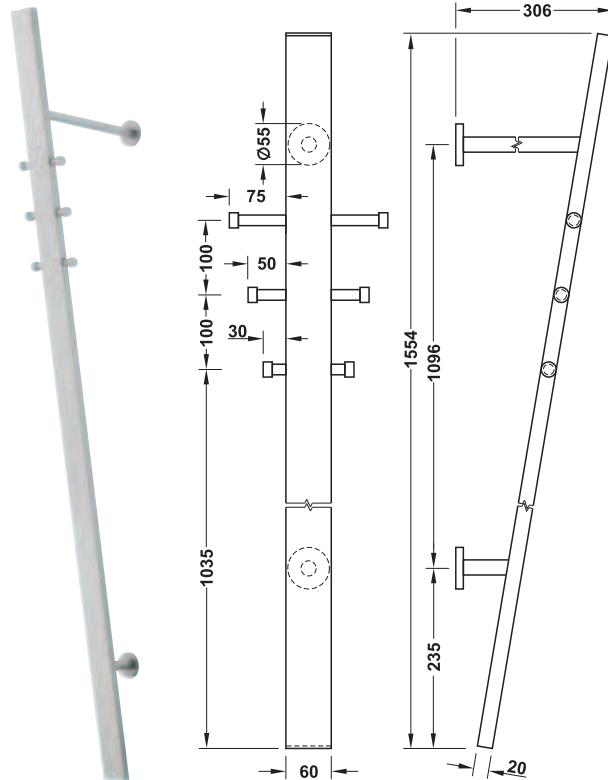

1

Garderoben

Montage

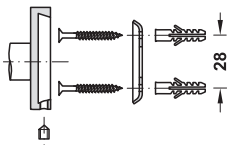

- > Werkstoff: Edelstahl, Güte 1.4301
- > Ausführung: mit 6 feststehenden Haken
- > Montage: für Wandmontage
- > Befestigungsmaterial im Lieferumfang enthalten (Spanlattenschrauben Ø 4,0 x 45 mm und Dübel)

Oberfläche	Artikel-Nr.
matt gebürstet	844.17.030

Abpackung: 1 Stück

DGH-M 2018, HIDE-de, 06/18; Maßangaben unverbindlich. Konstruktionsänderungen vorbehalten.

1

Garderoben

Garderobe

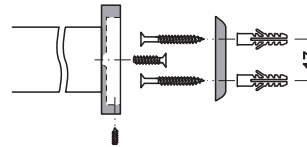
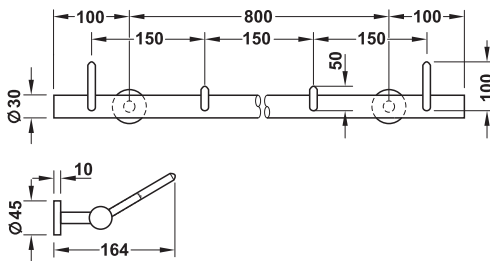
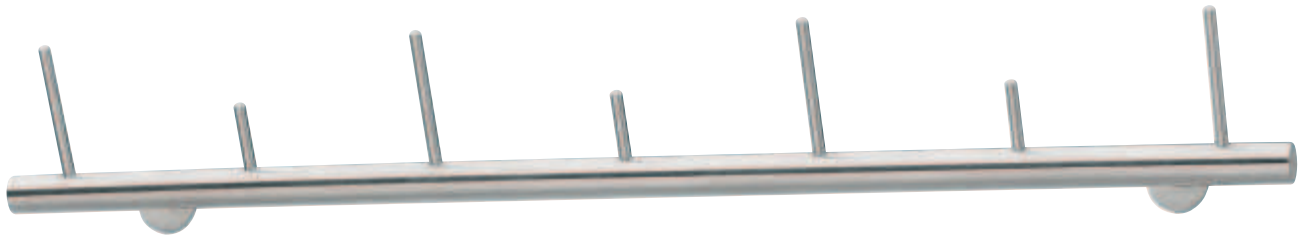

- > Werkstoff: Edelstahl, Güte 1.4305
- > Oberfläche: matt gebürstet
- > Montage: für Wandmontage
- > Ausführung: 4 Haken Länge 100 mm,  
3 Haken Länge 50 mm
- > Befestigungsmaterial im Lieferumfang enthalten  
(Spanplattenschrauben  $\varnothing$  4,0 x 45 mm und Dübel)

**Kundenindividuelle Topco-Leistungen**  
Andere Größen und Ausführungen sind  
als Topco-Leistung lieferbar.

Länge mm	Artikel-Nr.
1.000	844.19.010

Abpackung: 1 Stück

Topco-Leistungen

► MB 1.379

DGH-M 2018; HDE-de, 06/18; Maßangaben unverbindlich. Konstruktionsänderungen vorbehalten.



Garderobe – Topco



1

Garderoben

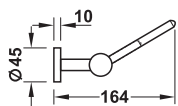
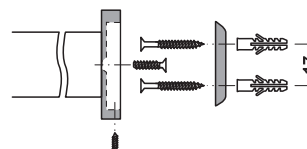
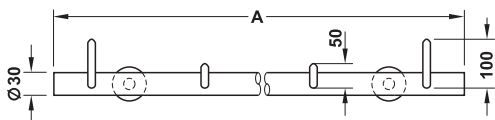
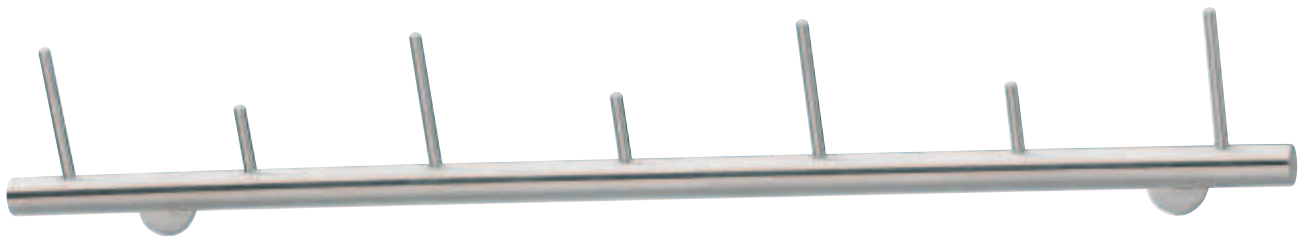

- > Werkstoff: Edelstahl, Güte 1.4305
- > Oberfläche: matt gebürstet
- > Montage: für Wandmontage
- > Befestigungsmaterial im Lieferumfang enthalten

**topCo** KUNDENINDIVIDUELL  
BEREITS AB EINEM STÜCK

Folgende Eigenschaften können Sie wählen:

- > Länge (Maß A)
- > Anzahl Stützen

Länge mm	Artikel-Nr.
Fixlänge (bis 2.000 mm)	844.19.019

Abpackung: 1 Stück

**Bestellhinweis**

Zur Stabilisierung ist ab 1.400 mm eine dritte Stütze erforderlich  
Die Anzahl der Haken ergibt sich aus der Länge der Garderobe.

DGH-M 2018, HIDE-de, 06/18; Maßangaben unverbindlich. Konstruktionsänderungen vorbehalten.

Standardmaße

► MB 1.378

Garderobe

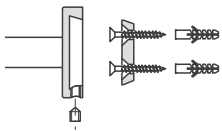
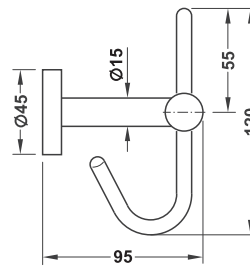
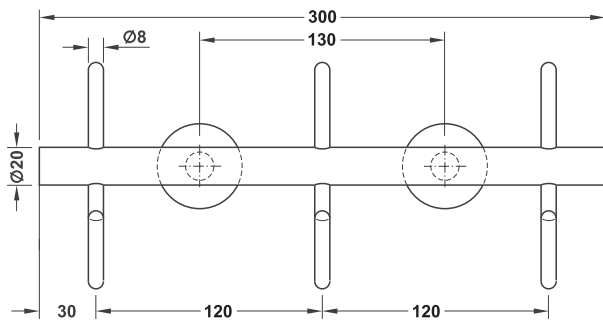
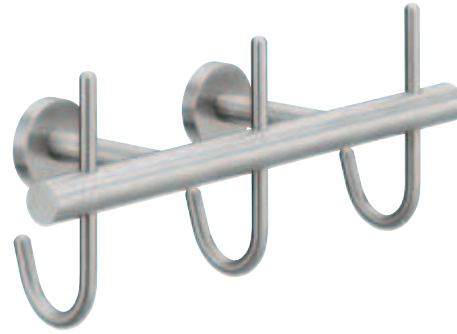

- > Werkstoff: Edelstahl, Güte 1.4305
- > Oberfläche: matt gebürstet
- > Montage: für Wandmontage
- > Ausführung: 3 nach hinten gedrehte Haken, ideal für Anwendung im Objekt
- > Befestigungsmaterial im Lieferumfang enthalten (Spanplattenschrauben Ø 4,0 x 45 mm und Dübel)

**Kundenindividuelle Topco-Leistungen**  
Andere Größen und Ausführungen sind als Topco-Leistung lieferbar.

Länge mm	Artikel-Nr.
300	844.16.070

Abpackung: 1 Stück

Garderobe – Topco

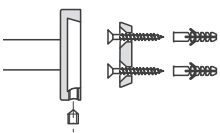
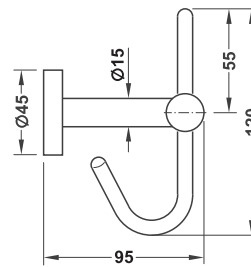
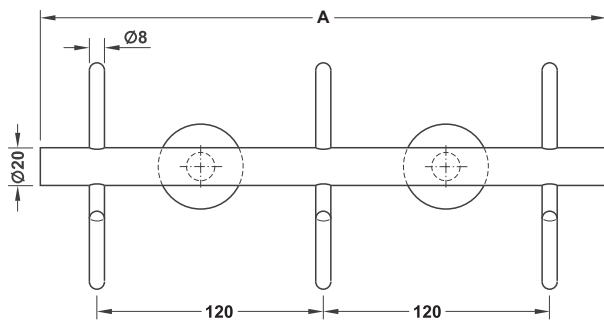
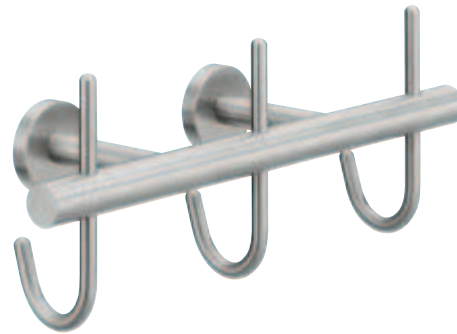

- > Werkstoff: Edelstahl, Güte 1.4305
- > Oberfläche: matt gebürstet
- > Montage: für Wandmontage
- > Ausführung: nach hinten gedrehte Haken, ideal für Anwendung im Objekt
- > Befestigungsmaterial im Lieferumfang enthalten

**topCo** KUNDENINDIVIDUELL  
BEREITS AB EINEM STÜCK

Folgende Eigenschaften können Sie wählen:

- > Länge (Maß A)
- > Anzahl Stützen

Länge mm	Artikel-Nr.
Fixlänge (bis 2.000 mm)	844.16.079

Abpackung: 1 Stück

**Bestellhinweis**

Zur Stabilisierung ist ab 1.400 mm eine dritte Stütze erforderlich. Die Anzahl der Haken ergibt sich aus der Länge der Garderobe.

Standardmaße

► MB 1.380

1  
Garderoben

Garderobe

1

Garderoben

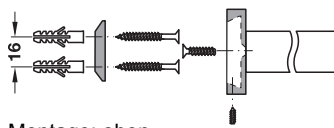
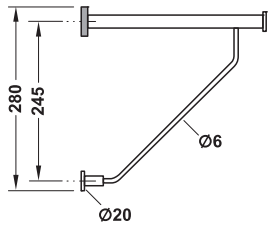
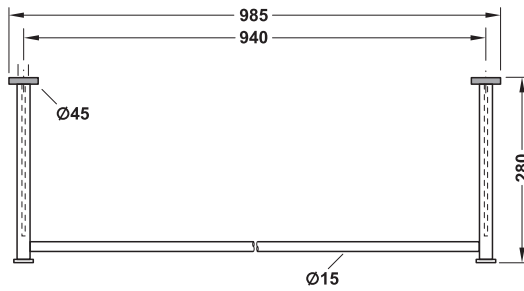

Montage: oben

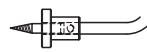

Montage: unten

- > Werkstoff: Edelstahl, Güte 1.4305
- > Oberfläche: matt gebürstet
- > Montage: für Wandmontage
- > Befestigungsmaterial im Lieferumfang enthalten (Spanlattenschrauben Ø 4,0 x 45 mm, Stockschraube M6 und Dübel)

**Kundenindividuelle Topco-Leistungen**  
Andere Größen und Ausführungen sind als Topco-Leistung lieferbar.

Länge mm	Artikel-Nr.
985	844.19.000

Abpackung: 1 Stück

Garderobe – Topco

1

Garderoben

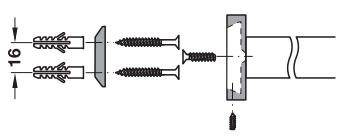
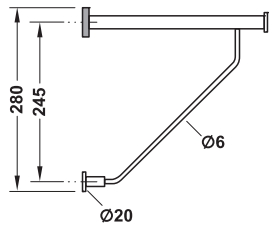
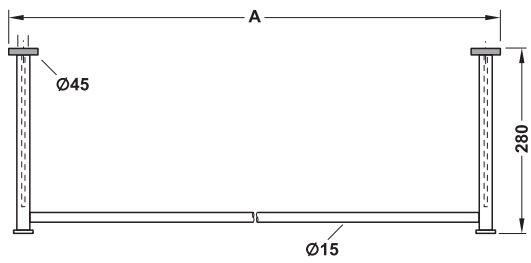

Montage: oben

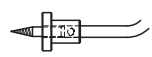

Montage: unten

- > Werkstoff: Edelstahl, Güte 1.4305
- > Oberfläche: matt gebürstet
- > Montage: für Wandmontage
- > Befestigungsmaterial im Lieferumfang enthalten

Länge mm	Artikel-Nr.
Fixlänge (bis 2.000 mm)	844.19.009

Abpackung: 1 Stück

**topCo** KUNDENINDIVIDUELL  
BEREITS AB EINEM STÜCK

- Folgende Eigenschaften können Sie wählen:
- > Länge (Maß A)
  - > Anzahl Stützen

- Bestellhinweis**
- Zur Stabilisierung sind erforderlich
- > ab Länge 1.200 mm: 3 Stützen
  - > ab Länge 1.600 mm: 4 Stützen

DGH-M 2018, HIDE-de, 06/18; Maßangaben unverbindlich. Konstruktionsänderungen vorbehalten.

Standardmaße ▶ MB 1.382

Garderobe



Leichte Sommerjacken benötigen  
4–6 cm Platz. Für Winterjacken sind  
6–8 cm zu berücksichtigen.

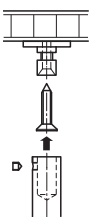
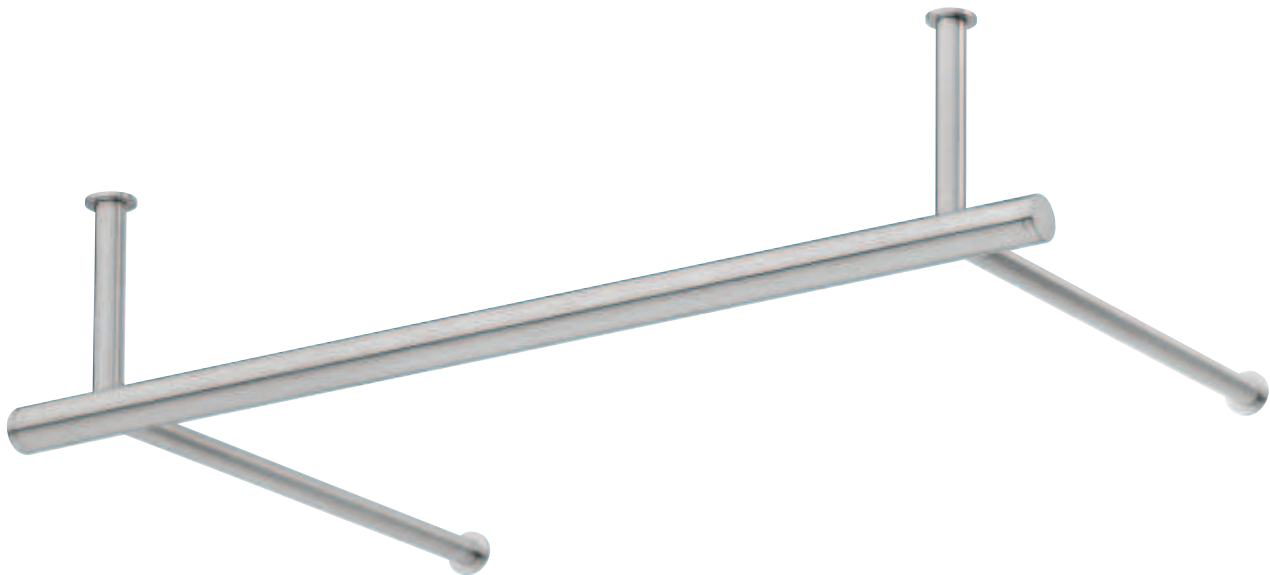
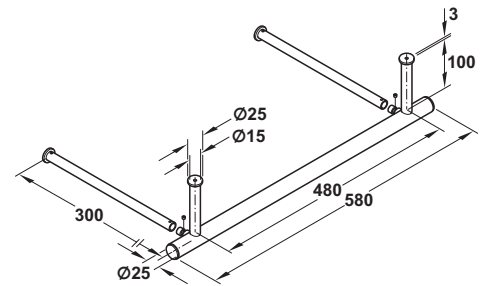

Montage-Variante  
Spanplattenschraube Hospa

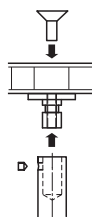

Montage-Variante  
Gewindeschraube M5

**Hinweis**

Streben zur Holzrückwand sind unmontiert.

**Kundenindividuelle Topco-Leistungen**

Andere Größen und Ausführungen sind  
als Topco-Leistung lieferbar.

- > Werkstoff: Edelstahl, Güte 1.4305
- > Oberfläche: matt gebürstet
- > Einsatzbereich: zum Schrauben unter den Fachboden und an die Holzrückwand

Länge mm	Artikel-Nr.
580	844.19.030

Abpackung: 1 Stück

Topco-Leistungen	► MB 1.385
Gewindeschrauben Senkkopf M5	► MB 1.471
Spanplattenschrauben Hospa Senkkopf Ø 3,5 mm	► MB 1.470



Garderobe – Topco



Leichte Sommerjacken benötigen 4–6 cm Platz. Für Winterjacken sind 6–8 cm zu berücksichtigen.



1

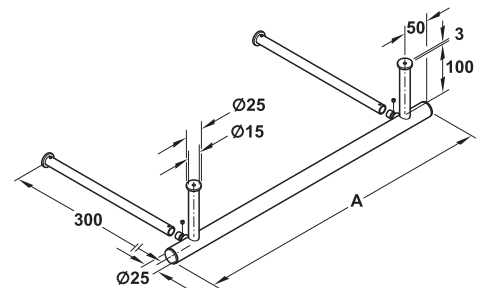

Garderoben

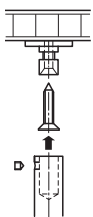
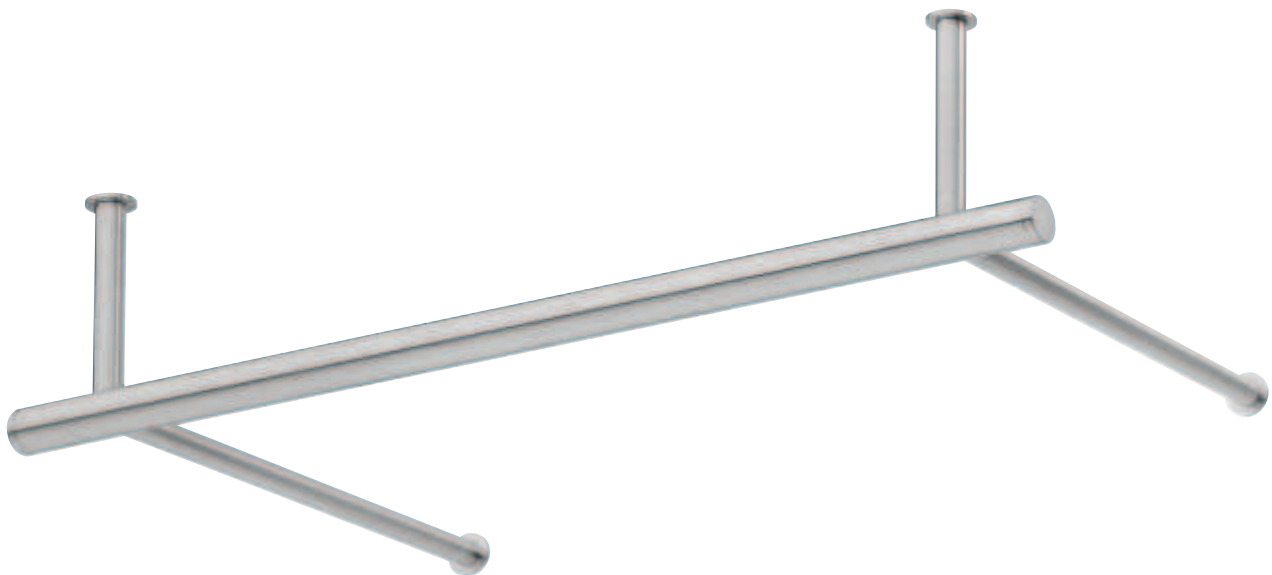

Montage-Variante  
Spanplattenschraube Hospa

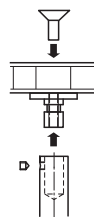

Montage-Variante  
Gewindeschraube M5

**Hinweis**

Streben zur Holzrückwand sind unmontiert.

- > Werkstoff: Edelstahl, Güte 1.4305
- > Oberfläche: matt gebürstet
- > Einsatzbereich: zum Schrauben unter den Fachboden und an die Holzrückwand

Länge mm	Artikel-Nr.
Fixlänge (bis 2.000 mm)	844.19.039

Abpackung: 1 Stück

**Bestellhinweis**

- Zur Stabilisierung sind erforderlich
- > ab Länge 1.000 mm: 3 Stützen
  - > ab Länge 1.600 mm: 4 Stützen

**topCo** KUNDENINDIVIDUELL  
BEREITS AB EINEM STÜCK

Folgende Eigenschaften können Sie wählen:

- > Länge (Maß A)
- > Anzahl Stützen

Standardmaße	► MB 1.384
Gewindeschrauben Senkkopf M5	► MB 1.471
Spanplattenschrauben Hospa Senkkopf Ø 3,5 mm	► MB 1.470

DGH-M 2018, HDE-de, 06/18; Maßangaben unverbindlich. Konstruktionsänderungen vorbehalten.



Garderobe



Leichte Sommerjacken benötigen 4–6 cm Platz. Für Winterjacken sind 6–8 cm zu berücksichtigen.

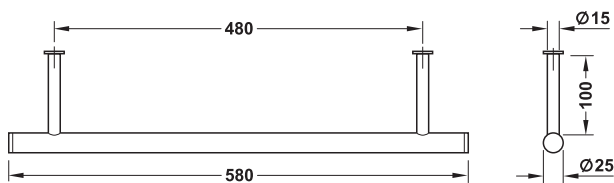
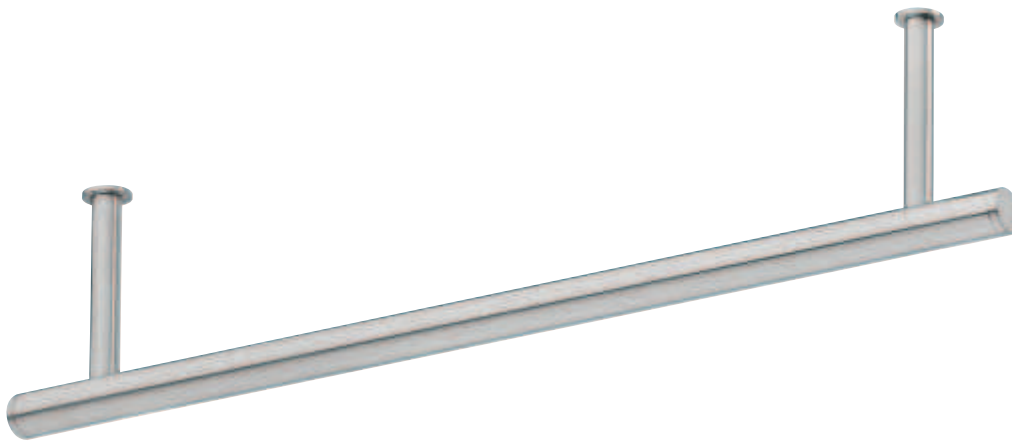

- > Werkstoff: Edelstahl, Güte 1.4305
- > Einsatzbereich: zum Schrauben unter den Fachboden

Länge mm	Artikel-Nr.
580	844.19.020

Abpackung: 1 Stück

**Bestellhinweis**

Diese Garderobe ist als Sonderanfertigung in Längen bis 2.000 mm lieferbar. Ab Länge 1.000 mm ist eine dritte Stütze, ab 1.600 mm eine vierte Stütze erforderlich.

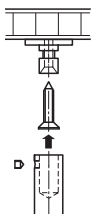

Montage-Variante  
Spanplattenschraube Hospa

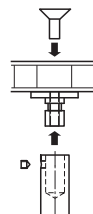

Montage-Variante  
Gewindeschraube M5

**Kundenindividuelle Topco-Leistungen**

Andere Größen und Ausführungen sind als Topco-Leistung lieferbar.

Topco-Leistungen	► MB 1.387
Gewindeschrauben Senkkopf M5	► MB 1.471
Spanplattenschrauben Hospa Senkkopf Ø 3,5 mm	► MB 1.470

Garderobe – Topco



Leichte Sommerjacken benötigen 4–6 cm Platz. Für Winterjacken sind 6–8 cm zu berücksichtigen.

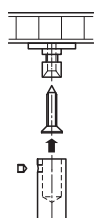
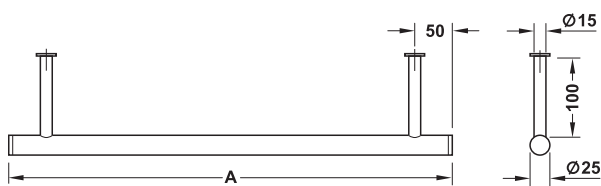
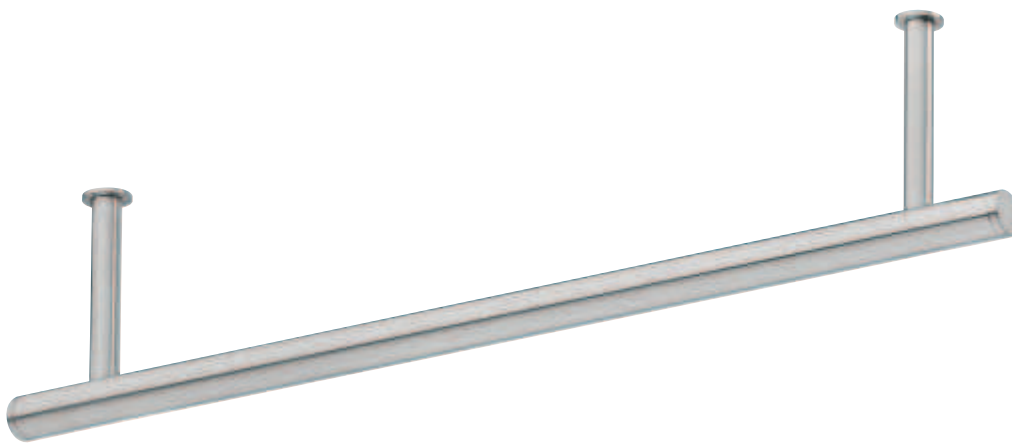

Montage-Variante  
Spanplattenschraube Hospa

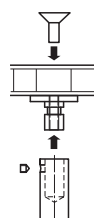

Montage-Variante  
Gewindeschraube M5

- > Werkstoff: Edelstahl, Güte 1.4305
- > Oberfläche: matt gebürstet
- > Einsatzbereich: zum Schrauben unter den Fachboden

Länge mm	Artikel-Nr.
Fixlänge (bis 2.000 mm)	844.19.029

Abpackung: 1 Stück

**Bestellhinweis**

- Zur Stabilisierung sind erforderlich
- > ab Länge 1.000 mm: 3 Stützen
  - > ab Länge 1.600 mm: 4 Stützen

**topCo** KUNDENINDIVIDUELL  
BEREITS AB EINEM STÜCK

Folgende Eigenschaften können Sie wählen:

- > Länge (Maß A)
- > Anzahl Stützen

Standardmaße	► MB 1.386
Gewindeschrauben Senkkopf M5	► MB 1.471
Spanplattenschrauben Hospa Senkkopf Ø 3,5 mm	► MB 1.470

Garderobe

1

Garderoben

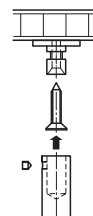
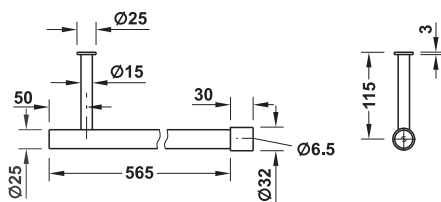

Montage-Variante  
Spanplattenschraube Hospa

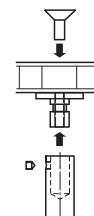

Montage-Variante  
Gewindeschraube M5

Seitenwandmontage über Schrankrohrlager

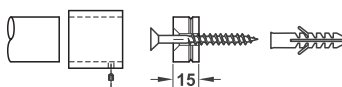

**Hinweis**  
Streben sind unmontiert.

**Kundenindividuelle Topco-Leistungen**  
Andere Größen und Ausführungen sind als Topco-Leistung lieferbar.

- > Werkstoff: Edelstahl, Güte 1.4305
- > Oberfläche: matt gebürstet
- > Einsatzbereich: zum Schrauben unter den Fachboden und an die Seitenwand

Länge mm	Artikel-Nr.
595	844.17.040

Abpackung: 1 Stück

Topco-Leistungen	► MB 1.389
Gewindeschrauben Senkkopf M5	► MB 1.471
Spanplattenschrauben Senkkopf Hospa Ø 5 mm	► MB 1.470
Spanplattenschrauben Senkkopf Hospa Ø 3,5 mm	► MB 1.470

DGH-M 2018; HDE-de, 06/18; Maßangaben unverbindlich. Konstruktionsänderungen vorbehalten.

Garderobe – Topco



1

Garderoben

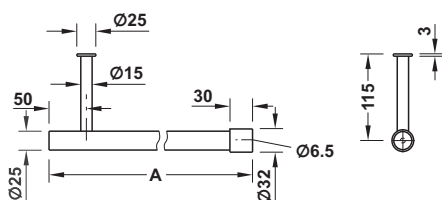

Seitenwandmontage über Schrankrohrlager

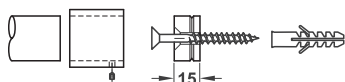

**Hinweis**

Streben sind unmontiert.

**Bestellhinweis**

- Zur Stabilisierung sind erforderlich  
 > ab Länge 1.000 mm: 2 Stützen  
 > ab Länge 1.600 mm: 3 Stützen

**topCo** KUNDENINDIVIDUELL  
BEREITS AB EINEM STÜCK

Folgende Eigenschaften können Sie wählen:

- > Länge (Maß A)
- > Anzahl Stützen

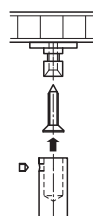

Montage-Variante  
Spanplattenschraube Hospa

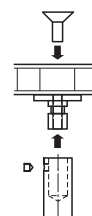

Montage-Variante  
Gewindeschraube M5

- > Werkstoff: Edelstahl, Güte 1.4305
- > Oberfläche: matt gebürstet
- > Einsatzbereich: zum Schrauben unter den Fachboden und an die Seitenwand

Länge mm	Artikel-Nr.
Fixlänge (bis 2.000 mm)	844.17.999

Abpackung: 1 Stück

Standardmaße	► MB 1.388
Gewindeschrauben Senkkopf M5	► MB 1.471
Spanplattenschrauben Hospa Senkkopf Ø 5 mm	► MB 1.470
Spanplattenschrauben Hospa Senkkopf Ø 3,5 mm	► MB 1.470

DGH-M 2018, HDE-de, 06/18; Maßangaben unverbindlich. Konstruktionsänderungen vorbehalten.

## Garderobenbügel

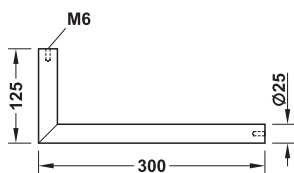
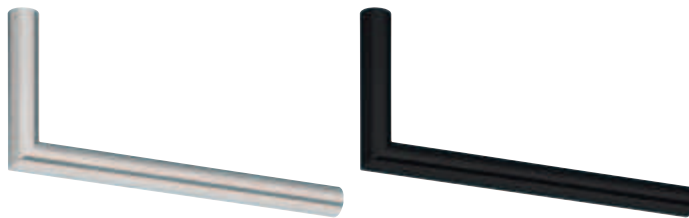

- > Werkstoff: Edelstahl, Güte 1.4301/AISI 304
- > Einsatzbereich: Montage unter dem Fachboden und an der Rückwand
- > Höhe: 125 mm
- > Bügel-Durchmesser: 25 mm

Länge mm	Oberfläche/Farbe	Artikel-Nr.
300	matt gebürstet	843.68.050
	schwarz matt, RAL 9017	843.68.070

Abpackung: 1 Stück

### Kundenindividuelle Topco-Leistungen

Andere Größen und Ausführungen sind als Topco-Leistung lieferbar.

## Garderobenbügel – Topco

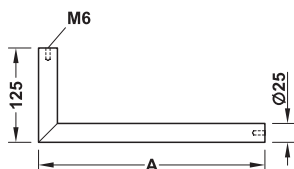

- > Werkstoff: Edelstahl, Güte 1.4301/AISI 304
- > Einsatzbereich: Montage unter dem Fachboden und an der Rückwand
- > Höhe: 125 mm
- > Bügel-Durchmesser: 25 mm

Länge mm	Oberfläche/Farbe	Artikel-Nr.
Fixlänge (bis 2.000 mm)	matt gebürstet	843.68.059
	schwarz matt, RAL 9017	843.68.058

Abpackung: 1 Stück

### Bestellhinweis

Zur Stabilisierung sind erforderlich

- > ab Länge 1.000 mm: 2 Stützen
- > ab Länge 1.600 mm: 3 Stützen

**topCo** KUNDENINDIVIDUELL  
BEREITS AB EINEM STÜCK

Folgende Eigenschaften können Sie wählen:

- > Länge (Maß A)
- > Anzahl Stützen

Gewindeschrauben Senkkopf M6

► MB 1.471



Garderobenbügel

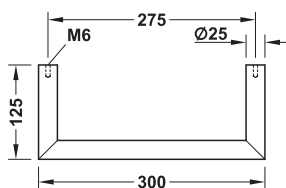
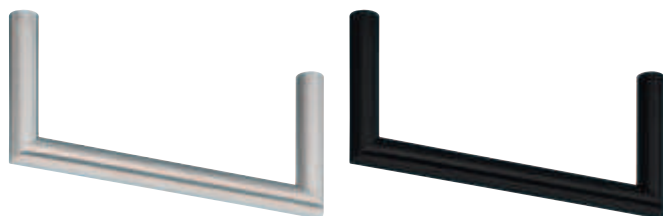

- > Werkstoff: Edelstahl, Güte 1.4301/AISI 304
- > Einsatzbereich: Montage unter dem Fachboden
- > Höhe: 125 mm
- > Bügel-Durchmesser: 25 mm

Länge mm	Oberfläche/Farbe	Artikel-Nr.
300	matt gebürstet	843.68.000
	schwarz matt, RAL 9017	843.68.020

Abpackung: 1 Stück

**Kundenindividuelle Topco-Leistungen**

Andere Größen und Ausführungen sind als Topco-Leistung lieferbar.

Garderobenbügel – Topco

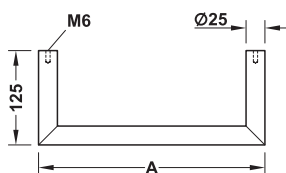
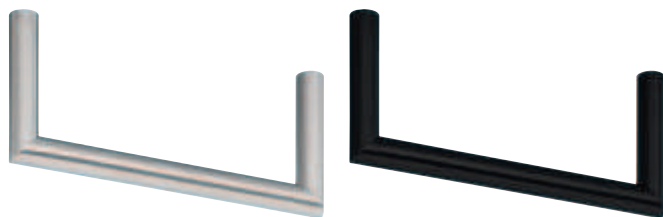

- > Werkstoff: Edelstahl, Güte 1.4301/AISI 304
- > Einsatzbereich: Montage unter dem Fachboden
- > Höhe: 125 mm
- > Bügel-Durchmesser: 25 mm

Länge mm	Oberfläche/Farbe	Artikel-Nr.
Fixlänge	matt gebürstet	843.68.009
(bis 2.000 mm)	schwarz matt, RAL 9017	843.68.008

Abpackung: 1 Stück

**Bestellhinweis**

- Zur Stabilisierung sind erforderlich
- > ab Länge 1.000 mm: 3 Stützen
- > ab Länge 1.600 mm: 4 Stützen

**topCo** KUNDENINDIVIDUELL  
BEREITS AB EINEM STÜCK

Folgende Eigenschaften können Sie wählen:

- > Länge (Maß A)
- > Anzahl Stützen

Gewindeschrauben Senkkopf M6

► MB 1.471

DGH-M 2018, HIDE-de, 06/18; Maßangaben unverbindlich. Konstruktionsänderungen vorbehalten.

15.04.2020  
ID 4941

## Garderobenbügel

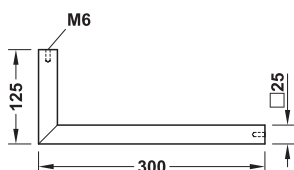

- > Werkstoff: Edelstahl, Güte 1.4301/AISI 304
- > Einsatzbereich: Montage unter dem Fachboden und an der Rückwand
- > Höhe: 125 mm
- > Querschnitt: Bügel 25 x 25 mm

Länge mm	Oberfläche/Farbe	Artikel-Nr.
300	matt gebürstet	843.68.060
	schwarz matt, RAL 9017	843.68.030

Abpackung: 1 Stück

### Kundenindividuelle Topco-Leistungen

Andere Größen und Ausführungen sind als Topco-Leistung lieferbar.

## Garderobenbügel – Topco

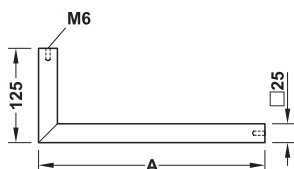

- > Werkstoff: Edelstahl, Güte 1.4301/AISI 304
- > Einsatzbereich: Montage unter dem Fachboden und an der Rückwand
- > Höhe: 125 mm
- > Querschnitt: Bügel 25 x 25 mm

Länge mm	Oberfläche/Farbe	Artikel-Nr.
Fixlänge (bis 2.000 mm)	matt gebürstet	843.68.069
	schwarz matt, RAL 9017	843.68.068

Abpackung: 1 Stück

### Bestellhinweis

- Zur Stabilisierung sind erforderlich
- > ab Länge 1.000 mm: 2 Stützen
  - > ab Länge 1.600 mm: 3 Stützen

**topCo** KUNDENINDIVIDUELL  
BEREITS AB EINEM STÜCK

Folgende Eigenschaften können Sie wählen:

- > Länge (Maß A)
- > Anzahl Stützen

Gewindeschrauben Senkkopf M6

► MB 1.471



Garderobenbügel

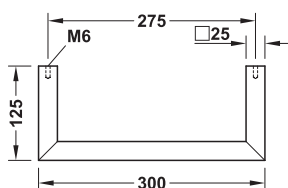
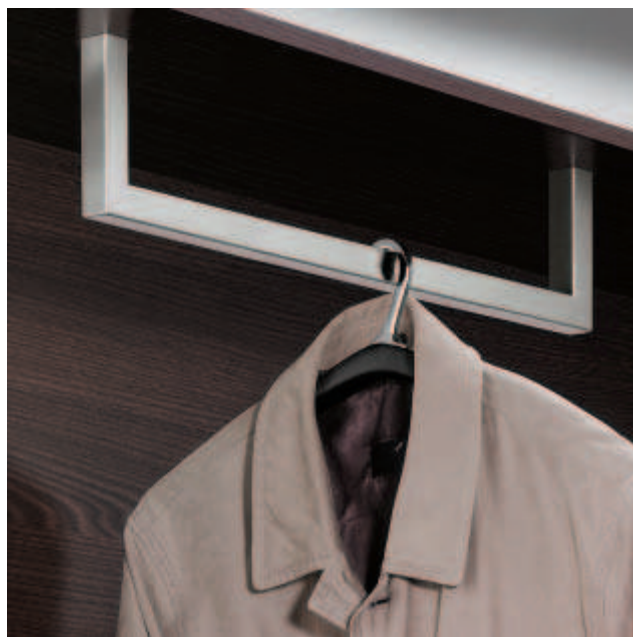
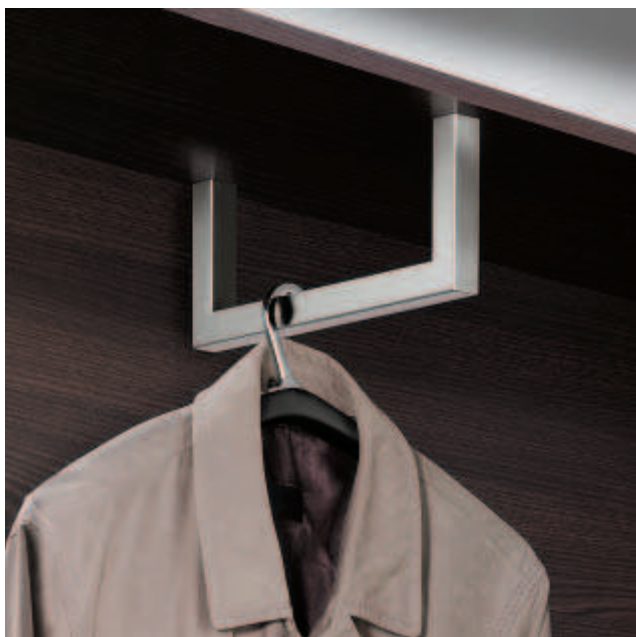

- > Werkstoff: Edelstahl, Güte 1.4301/AISI 304
- > Einsatzbereich: Montage unter dem Fachboden
- > Höhe: 125
- > Querschnitt: Bügel 25 x 25 mm

Länge mm	Oberfläche/Farbe	Artikel-Nr.
300	matt gebürstet	843.68.010
	schwarz matt, RAL 9017	843.68.040

Abpackung: 1 Stück

**Kundenindividuelle Topco-Leistungen**

Andere Größen und Ausführungen sind als Topco-Leistung lieferbar.

Garderobenbügel – Topco

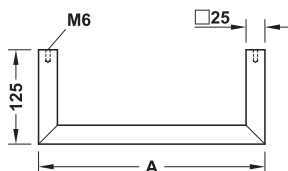

- > Werkstoff: Edelstahl, Güte 1.4301/AISI 304
- > Einsatzbereich: Montage unter dem Fachboden
- > Höhe: 125 mm
- > Querschnitt: Bügel 25 x 25 mm

Länge mm	Oberfläche/Farbe	Artikel-Nr.
Fixlänge (bis 2.000 mm)	matt gebürstet	843.68.019
	schwarz matt, RAL 9017	843.68.018

Abpackung: 1 Stück

**Bestellhinweis**

Zur Stabilisierung sind erforderlich

- > ab Länge 1.000 mm: 3 Stützen
- > ab Länge 1.600 mm: 4 Stützen

**topCo** KUNDENINDIVIDUELL  
BEREITS AB EINEM STÜCK

Folgende Eigenschaften können Sie wählen:

- > Länge (Maß A)
- > Anzahl Stützen

Gewindeschrauben Senkkopf M6

► MB 1.471

DGH-M 2018, HIDE-de, 06/18; Maßangaben unverbindlich. Konstruktionsänderungen vorbehalten.

15.04.2020  
ID 4941

1

Garderobe

Garderoben

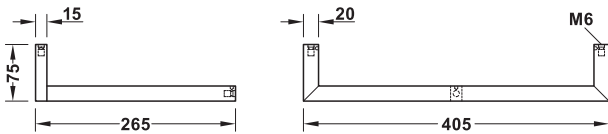

- > Werkstoff: Stahl
- > Oberfläche/Farbe: schwarz matt, RAL 9017, pulverbeschichtet
- > Einsatzbereich: zum Schrauben unter den Fachboden und an die Rückwand, zur direkten Befestigung mit Gewinde

Länge mm	Artikel-Nr.
405	844.19.040

Abpackung: 1 Stück

Gewindeschrauben Senkkopf M6

► MB 1.471

DGH-M 2018; HDE-de, 06/18; Maßangaben unverbindlich. Konstruktionsänderungen vorbehalten.

**DIESE SEITE WURDE BEWUSST  
LEER GELASSEN**

**INTENTIONAL BLANK PAGE**

1

Garderoben

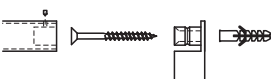
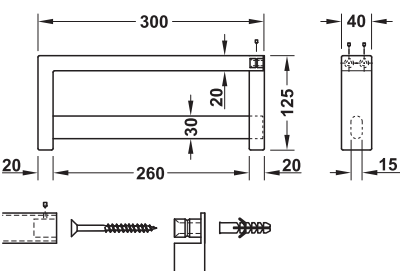
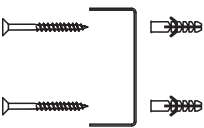
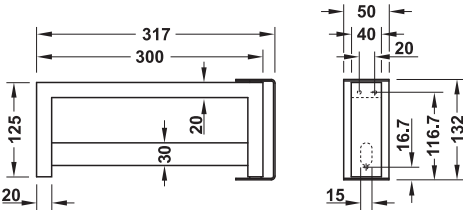
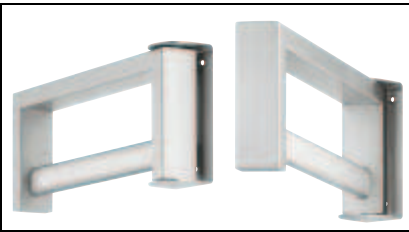

- > Werkstoff: Edelstahl, Güte 1.4305
- > Ausführung: schwenkbar
- > Montage: für Wandmontage
- > Befestigungsmaterial im Lieferumfang enthalten (Spanplattenschrauben Ø 3,0 x 40 mm)

Oberfläche	Artikel-Nr.
matt gebürstet	844.19.090

Abpackung: 1 Stück

- > Werkstoff: Edelstahl, Güte 1.4305
- > Montage: für Wandmontage
- > Befestigungsmaterial im Lieferumfang enthalten (Spanplattenschrauben Ø 4,0 x 45 mm und Dübel)

Oberfläche	Artikel-Nr.
matt gebürstet	844.19.050

Abpackung: 1 Stück

DGH-M 2018; HDE-de, 06/18; Maßangaben unverbindlich. Konstruktionsänderungen vorbehalten.

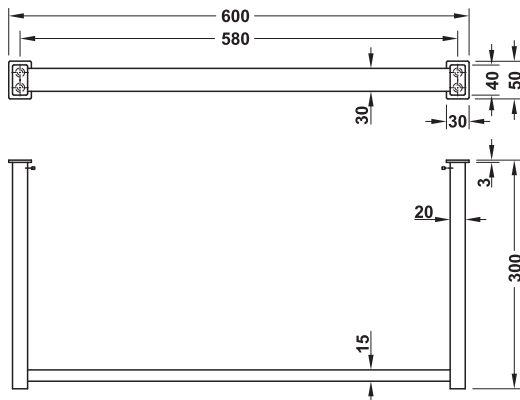
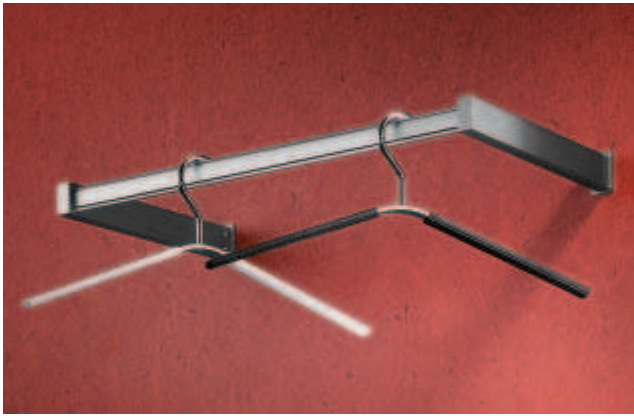

- > Werkstoff: Edelstahl, Güte 1.4305
- > Montage: für Wandmontage
- > Befestigungsmaterial im Lieferumfang enthalten (Spanplattenschrauben Ø 4,0 x 60 mm und Dübel)

Oberfläche	Artikel-Nr.
matt gebürstet	844.19.051

Abpackung: 1 Stück

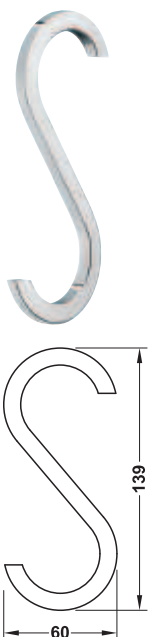

- > Einsatzbereich: zum Einhängen in Garderobenstangen bis Durchmesser 35 mm
- > Oberfläche: verchromt poliert

Höhe mm	Querschnitt mm	Artikel-Nr.
139	9 x 7	844.19.200

Abpackung: 1 Packung

**Hinweis**  
1 Packung enthält 2 Stück.

DGH-M 2018, HIDE-de, 06/18; Maßangaben unverbindlich. Konstruktionsänderungen vorbehalten.

1

Garderoben

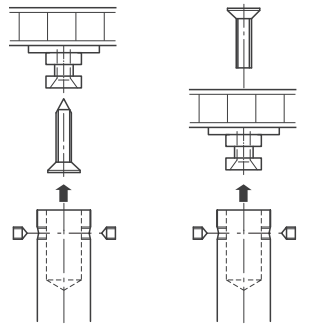
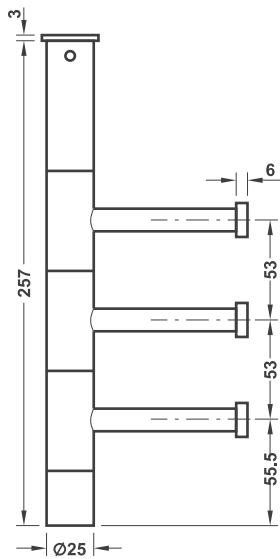
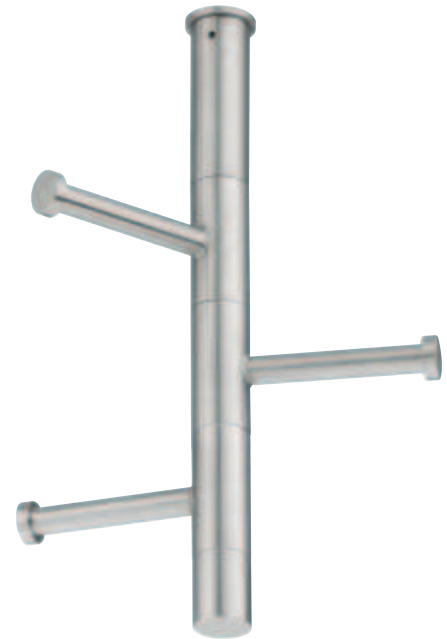

Montage-Variante  
Spanplatten-  
schraube Hospa

Montage-Variante  
Gewinde-  
schraube M6

- > Werkstoff: Edelstahl, Güte 1.4305
- > Ausführung: mit 3 drehbaren Haken
- > Einsatzbereich: zur Unterbodenmontage mit Befestigungsrosette zur direkten oder indirekten Montage

Oberfläche	Artikel-Nr.
matt gebürstet	844.11.020

Abpackung: 1 Stück

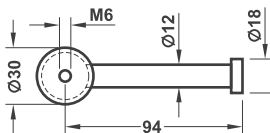

Gewindeschrauben Senkkopf M6 ▶ MB 1.471

Spanplattenschrauben Hospa Senkkopf Ø 3,5 mm ▶ MB 1.470

DGH-M 2018; HDE-de, 06/18; Maßangaben unverbindlich. Konstruktionsänderungen vorbehalten.



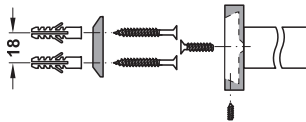
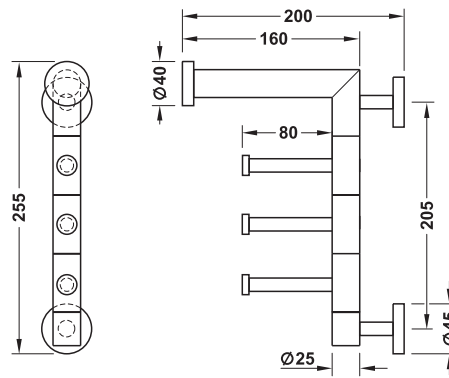
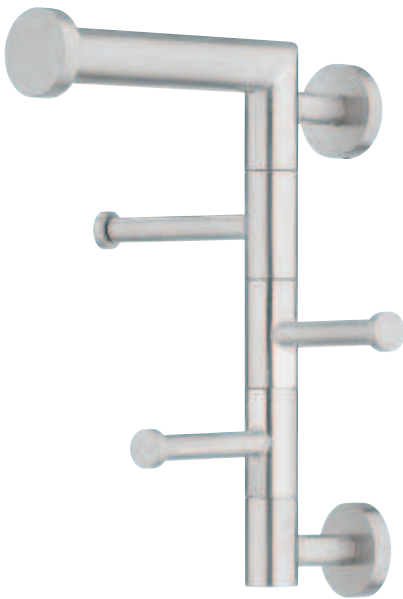

- > Werkstoff: Edelstahl, Güte 1.4305
- > Ausführung: mit drei drehbaren Haken
- > Montage: für Wandmontage
- > Befestigungsmaterial im Lieferumfang enthalten (Spanplattenschrauben Ø 4,0 x 45 mm und Dübel)

Oberfläche	Artikel-Nr.
matt gebürstet	844.17.011

Abpackung: 1 Stück

Garderobenleiste

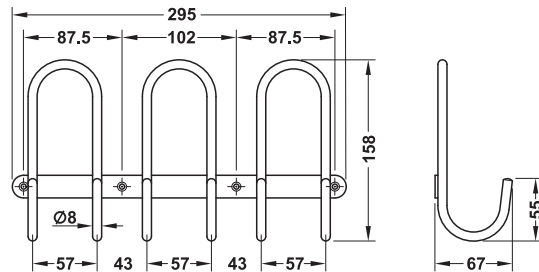
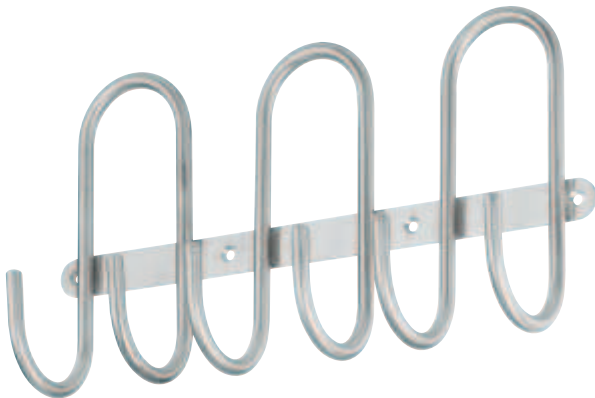

- > Werkstoff: Edelstahl, Güte 1.4301
- > Oberfläche: matt gebürstet
- > Befestigungsmaterial im Lieferumfang enthalten (Spanplattenschrauben Ø 3,0 x 40 mm und Dübel)

Breite mm	Tiefe mm	Höhe mm	Artikel-Nr.
295	67	158	844.69.010

Abpackung: 1 Stück

DGH-M 2018, HDE-de, 06/18; Maßangaben unverbindlich. Konstruktionsänderungen vorbehalten.



Wandgarderobe



**Kundenindividuelle Topco-Leistungen**  
Andere Größen und Ausführungen sind als Topco-Leistung lieferbar.

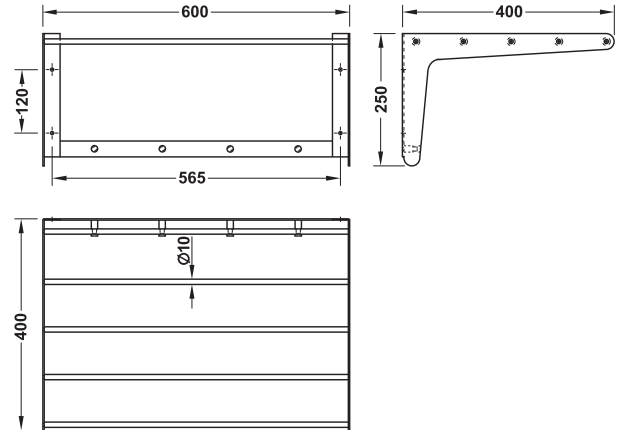
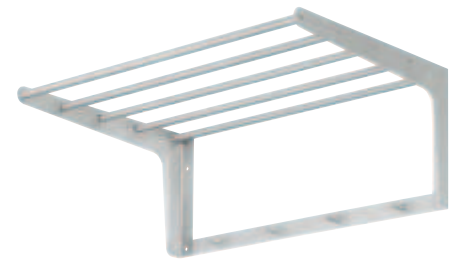

- > Werkstoff: Edelstahl, Güte 1.4301
- > Oberfläche: matt gebürstet
- > Ausführung: mit 4 Haken
- > Befestigungsmaterial im Lieferumfang enthalten

Breite mm	Tiefe mm	Höhe mm	Artikel-Nr.
600	400	250	844.19.060

Abpackung: 1 Stück

Schuhablage

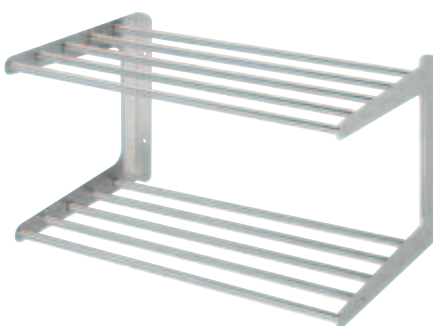

**Kundenindividuelle Topco-Leistungen**  
Andere Größen und Ausführungen sind als Topco-Leistung lieferbar.

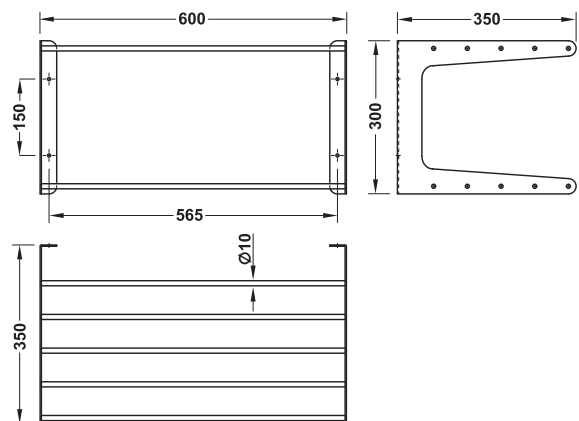

- > Werkstoff: Edelstahl, Güte 1.4301
- > Oberfläche: matt gebürstet
- > Befestigungsmaterial im Lieferumfang enthalten

Breite mm	Tiefe mm	Höhe mm	Artikel-Nr.
600	350	300	844.19.070

Abpackung: 1 Stück

Topco-Leistungen

► MB 1.399

DGH-M 2018; HDE-de, 06/18; Maßangaben unverbindlich. Konstruktionsänderungen vorbehalten.

Wandgarderobe – Topco

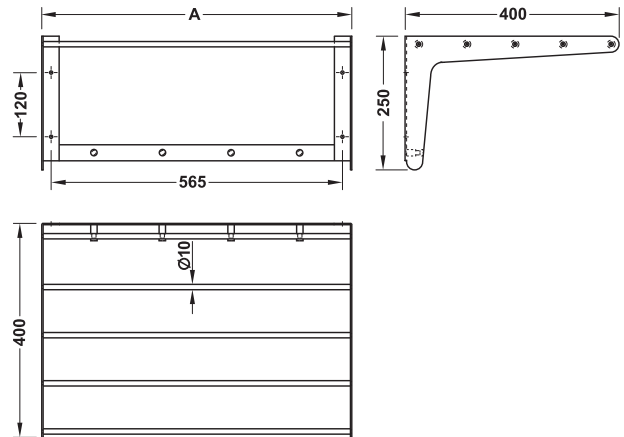
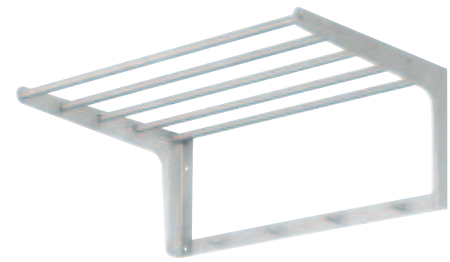

- > Werkstoff: Edelstahl, Güte 1.4301
- > Oberfläche: matt gebürstet
- > Befestigungsmaterial im Lieferumfang enthalten

Länge mm	Höhe mm	Artikel-Nr.
Fixlänge (bis 1.400 mm)	250	844.19.069

Abpackung: 1 Stück

**Bestellhinweis**

- > ab Länge 601 mm: mit 5 Haken
- > ab Länge 801 mm: mit 6 Haken
- > ab Länge 1.001 mm: mit 8 Haken

Zur Stabilisierung sind erforderlich  
> ab Länge 1.200 mm: 3 Stützen, unmontiert

Garderoben

**topCo** KUNDENINDIVIDUELL  
BEREITS AB EINEM STÜCK

Folgende Eigenschaften können Sie wählen:

- > Länge (Maß A)
- > Anzahl Haken
- > Anzahl Stützen

Schuhablage – Topco

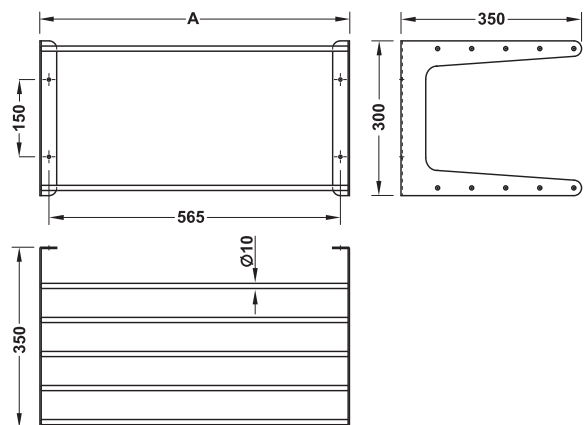
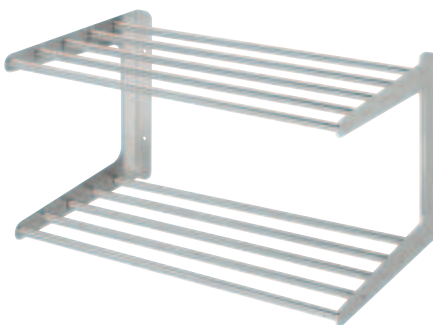

- > Werkstoff: Edelstahl, Güte 1.4301
- > Oberfläche: matt gebürstet
- > Befestigungsmaterial im Lieferumfang enthalten

Länge mm	Tiefe mm	Höhe mm	Artikel-Nr.
Fixlänge (bis 1.400 mm)	350	300	844.19.079

Abpackung: 1 Stück

**topCo** KUNDENINDIVIDUELL  
BEREITS AB EINEM STÜCK

Folgende Eigenschaften können Sie wählen:

- > Länge (Maß A)
- > Anzahl Stützen

**Bestellhinweis**

Zur Stabilisierung sind erforderlich  
> ab Länge 1.200 mm: 3 Stützen, unmontiert

Standardmaße ▶ MB 1.398

DGH-M 2018, HDE-de, 06/18; Maßangaben unverbindlich. Konstruktionsänderungen vorbehalten.

1

Garderoben

Wandgarderobe

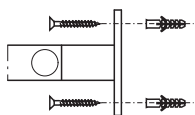
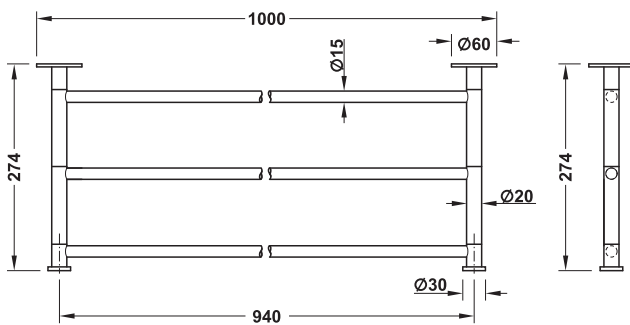
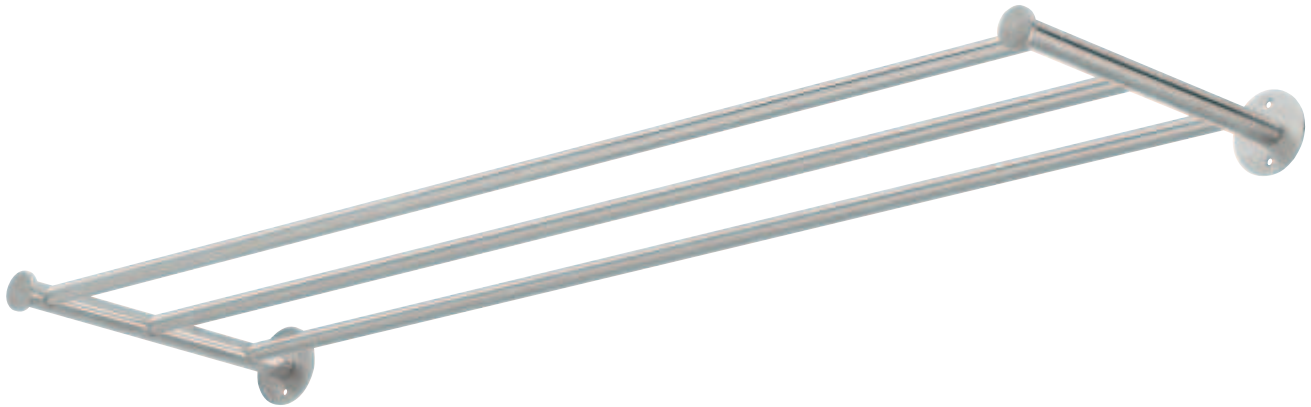

> Werkstoff: Edelstahl, Güte 1.4305

Oberfläche	Artikel-Nr.
matt gebürstet	844.19.080

Abpackung: 1 Stück

**Kundenindividuelle Topco-Leistungen**

Andere Größen und Ausführungen sind als Topco-Leistung lieferbar.

Topco-Leistungen

► MB 1.401

DGH-M 2018; HDE-de, 06/18; Maßangaben unverbindlich. Konstruktionsänderungen vorbehalten.

Wandgarderobe – Topco

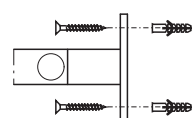
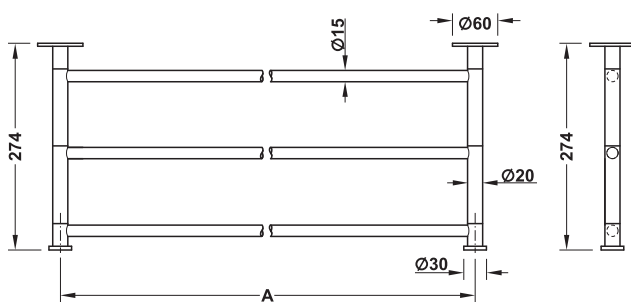
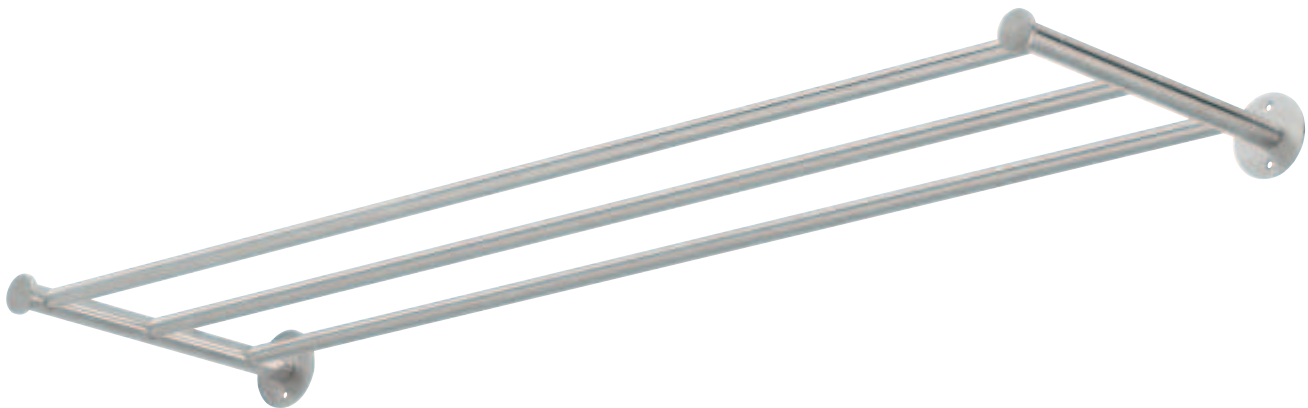

- > Werkstoff: Edelstahl, Güte 1.4305
- > Oberfläche: matt gebürstet
- > Befestigungsmaterial im Lieferumfang enthalten

Länge mm	Artikel-Nr.
Fixlänge (bis 2.000 mm)	844.19.089

Abpackung: 1 Stück

**topCo** KUNDENINDIVIDUELL  
BEREITS AB EINEM STÜCK

Folgende Eigenschaften können Sie wählen:

- > Länge (Maß A)
- > Anzahl Stützen

**Bestellhinweis**

- Zur Stabilisierung sind erforderlich
- > ab Länge 1.200 mm: 3 Stützen
  - > ab Länge 1.600 mm: 4 Stützen

Standardmaße

► MB 1.400

DGH-M 2018, HIDE-de, 06/18; Maßangaben unverbindlich. Konstruktionsänderungen vorbehalten.

1

Garderobenarm

Garderoben

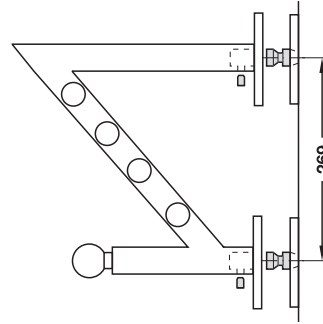
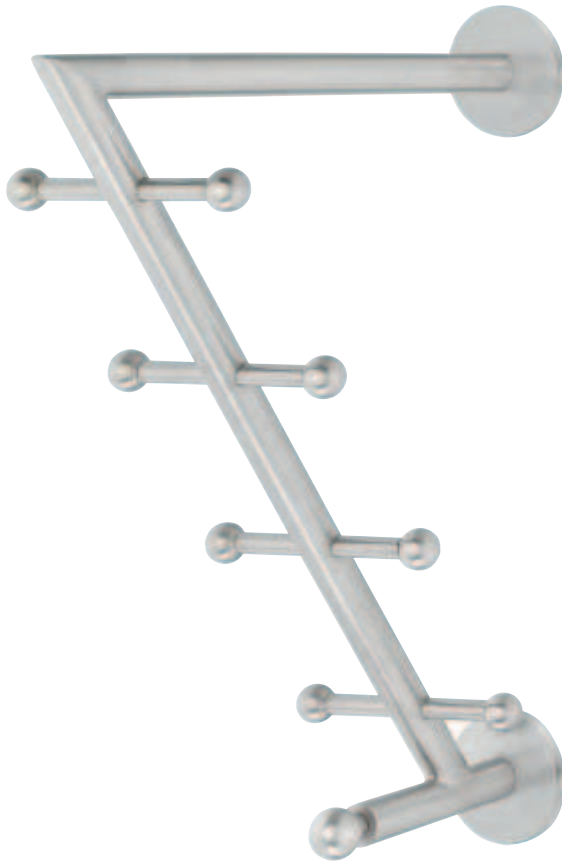

- > Werkstoff: Edelstahl, Güte 1.4301
- > Oberfläche: matt gebürstet
- > Befestigungsmaterial im Lieferumfang enthalten (Spanplattenschrauben  $\varnothing$  6,0 x 50 mm und Dübel)

Breite mm	Tiefe mm	Höhe mm	Artikel-Nr.
97	280	280	843.98.000

Abpackung: 1 Stück

Garderobenkonzole

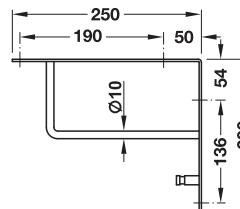

- > Werkstoff: Edelstahl, Güte 1.4305
- > Oberfläche: matt gebürstet
- > Befestigungsmaterial im Lieferumfang enthalten (Spanplattenschrauben  $\varnothing$  3,5 x 40 mm)

Breite mm	Tiefe mm	Höhe mm	Artikel-Nr.
20	250	200	842.46.000

Abpackung: 1 Stück

Garderobenstangenset



1

Garderoben

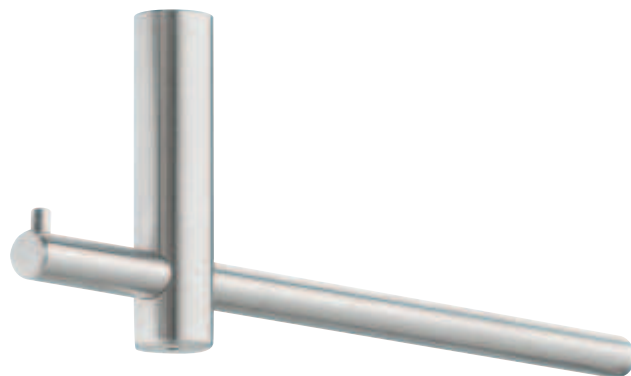

> Werkstoff: Edelstahl, Güte 1.4305/AISI 303  
> Oberfläche: matt gebürstet

Länge mm	Höhe mm	Bügel-Durchmesser mm	Artikel-Nr.
255	84	12	844.17.100
400	84	12	844.17.101

Abpackung: 1 Stück

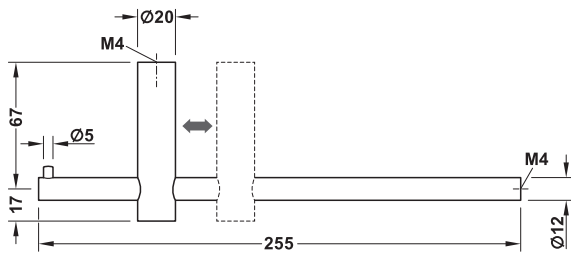

DGH-M 2018, HIDE-de, 06/18; Maßangaben unverbindlich. Konstruktionsänderungen vorbehalten.

passender Mantelhaken

► MB 1.421

16.05.2019  
ID 4542



1

Garderoben

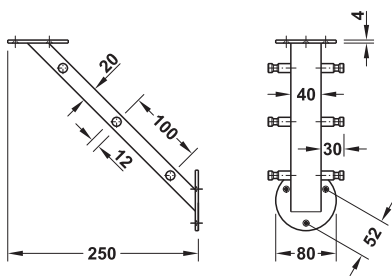

- > Werkstoff: Edelstahl, Güte 1.4305
- > Befestigungsmaterial im Lieferumfang enthalten

Oberfläche	Artikel-Nr.
matt gebürstet	844.20.010

Abpackung: 1 Stück

DGH-M 2018; HDE-de, 06/18; Maßangaben unverbindlich. Konstruktionsänderungen vorbehalten.



Garderobenstange

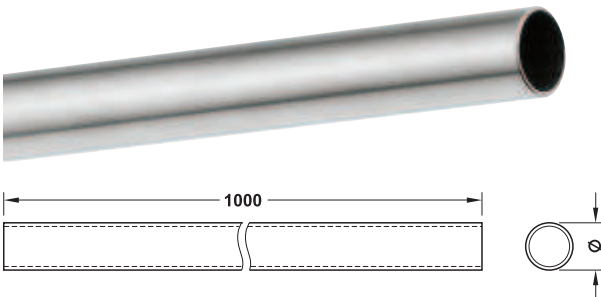

- > Werkstoff: Edelstahl, Güte 1.4301
- > Oberfläche: matt gebürstet
- > Länge: 1.000 mm
- > Materialdicke: 1,5 mm

Rohr-Durchmesser mm	Artikel-Nr.
20	801.41.014
25	801.41.015
30	801.41.016

Abpackung: 1 Stück

weitere Schrankrohre ▶ MB 8.23

Garderoben

Schrankrohlager

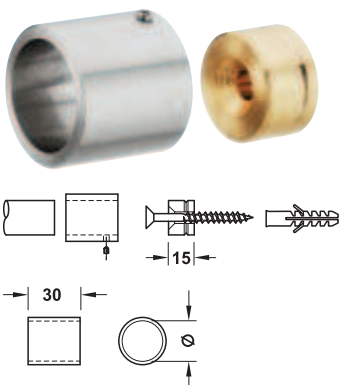

- > Werkstoff: Hülse: Edelstahl, Güte 1.4305, Buchse: Messing
- > Oberfläche: Hülse: matt gebürstet, Buchse: blank

verwendbar für	Artikel-Nr.
Rohrdurchmesser 20 mm	803.42.050
Rohrdurchmesser 25 mm	803.42.051
Rohrdurchmesser 30 mm	803.42.052

Abpackung: 2 Stück

weitere Schrankrohlager ▶ MB 8.24

Spanplattenschrauben Hospa Senkkopf Ø 5 mm ▶ MB 1.470

DGH-M 2018, HIDE-de, 06/18; Maßangaben unverbindlich. Konstruktionsänderungen vorbehalten.

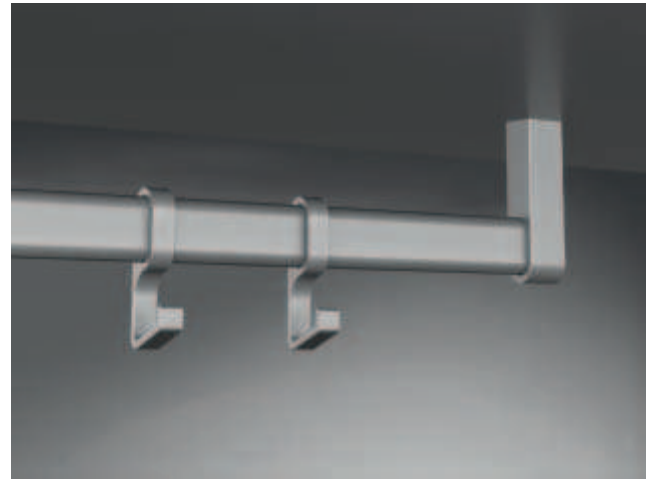

### Garderobenstange

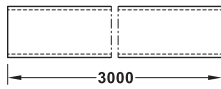
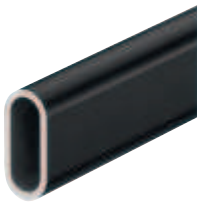

Aluminium

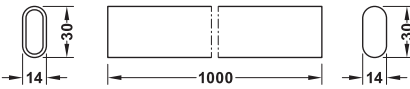

Eichenholz

> Durchmesser: 30 x 14 mm

Werkstoff	Länge mm	Oberfläche/Farbe	Artikel-Nr.
Aluminium	3000	schwarz eloxiert	801.86.303
		silberfarben eloxiert	801.86.913
Eichenholz	1000	Eiche gebürstet	801.86.401

Abpackung: 1 Stück

#### Hinweis

Wir empfehlen für die Garderobenstange aus Eichenholz eine maximale Spannweite von 1 Meter.  
Für das Aluminiumrohr empfehlen wir eine maximale Spannweite von 1,30 Metern.  
Bei größeren Längen sollte ein Mittelträger verwendet werden.

### Schrankrohlager

für Garderobenrohr OVA 30 x 14 mm

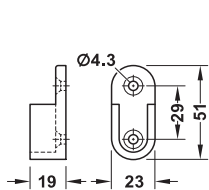

offen

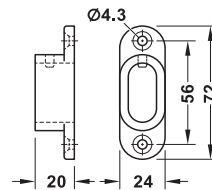

geschlossen

> Montage: zum Schrauben an die Seitenwand

Ausführung	Oberfläche/Farbe	Artikel-Nr.
offen	silber	803.70.900
	schwarz	803.70.300
geschlossen	silber	803.70.910
	schwarz	803.70.310

Abpackung: 1 Stück

Spanplattenschraube Hospa M4

► MB 1.470

**End-/Mittel-Deckenträger zum Schrauben von unten**

für Garderobenrohr OVA 30 x 14 mm

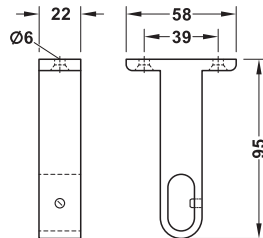
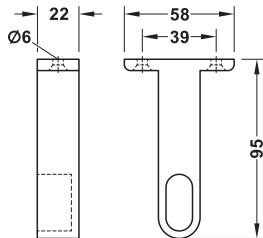

End-Deckenträger

Mittel-Deckenträger

> Montage: zum Schrauben an den Fachboden von unten

Ausführung	Oberfläche/Farbe	Artikel-Nr.
End-Deckenträger	silberfarben eloxiert	802.18.950
	schwarz eloxiert	802.18.350
Mittel-Deckenträger	silberfarben eloxiert	802.18.900
	schwarz eloxiert	802.18.300

Abpackung: 1 Stück

Spanplattenschraube Hospa M5

► MB 1.470

**End-/Mittel-Deckenträger zum Schrauben von oben**

für Garderobenrohr OVA 30 x 14 mm

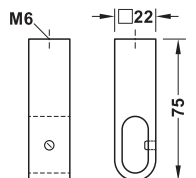
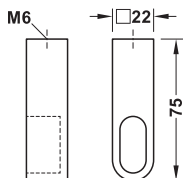

End-Deckenträger

Mittel-Deckenträger

> Montage: zum Schrauben von oben

Ausführung	Oberfläche/Farbe	Artikel-Nr.
End-Deckenträger	silberfarben eloxiert	802.18.960
	schwarz eloxiert	802.18.360
Mittel-Deckenträger	silberfarben eloxiert	802.18.910
	schwarz eloxiert	802.18.310

Abpackung: 1 Stück

Spanplattenschraube Panhead Hospa M5

► MB 1.470

**Einhängehaken**

für Garderobenrohr OVA 30 x 14 mm

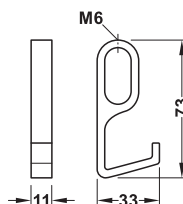

> Montage: zum Schieben auf das Schrankrohr

Oberfläche/Farbe	Artikel-Nr.
silberfarben eloxiert	803.70.990
schwarz eloxiert	803.70.390

Abpackung: 1 Stück

DGH-M 2018, HIDE-de, 06/18; Maßangaben unverbindlich. Konstruktionsänderungen vorbehalten.

Garderoben

1

Garderoben

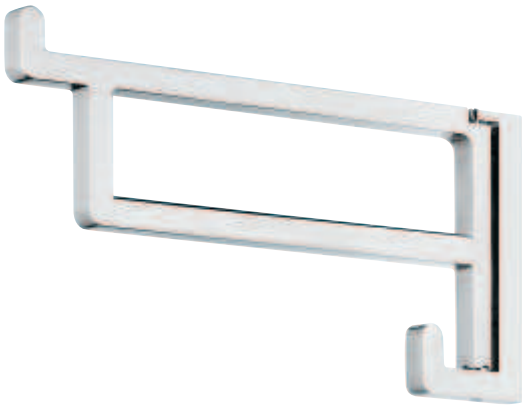

- > Werkstoff: Aluminium
- > Ausführung: Haken durch Anheben schwenkbar
- > Befestigungsmaterial im Lieferumfang enthalten (Spanplattenschrauben Ø 4,0 x 50 mm und Dübel)

Oberfläche	Artikel-Nr.
verchromt poliert	844.12.200

Abpackung: 1 Stück

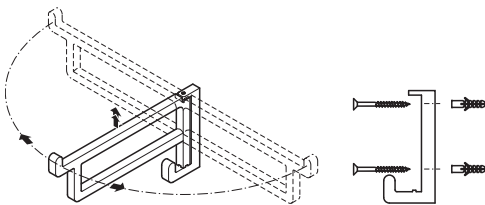
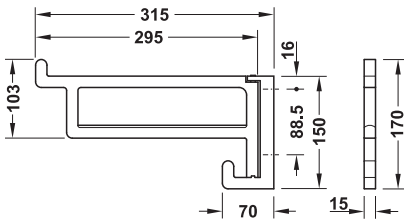



Platzsparende Garderobe, die bei Bedarf aufgeklappt werden kann und Platz für bis zu drei Kleiderbügel bietet. Zusätzlich können an den seitlichen Haken Taschen oder Schlüsselbünde aufgehängt werden. Bei Nichtgebrauch verschwindet der Haken mühelos im stilgerechten Gehäuse.

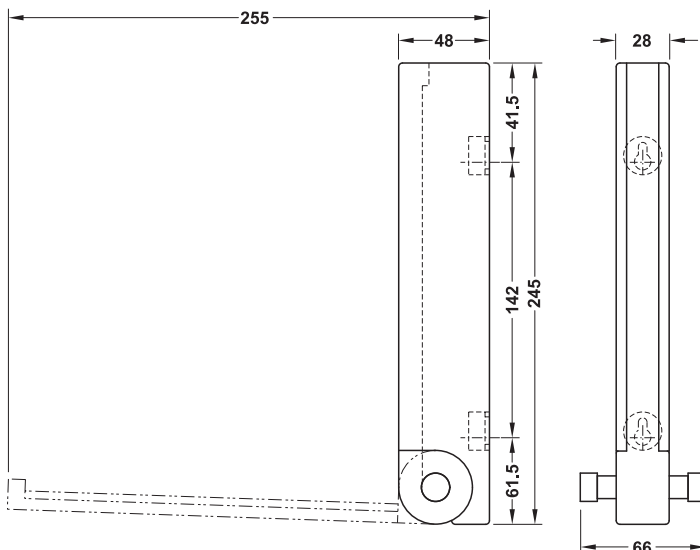

- > Ausführung: Haken klappbar, Ausladung 205 mm
- > Befestigungsmaterial im Lieferumfang enthalten (Spanplattenschrauben Ø 4,0 x 40 mm und Dübel)

Werkstoff	Oberfläche	Artikel-Nr.
Gehäuse: Nussbaum Haken: Aluminium	Gehäuse: geölt Haken: poliert	844.25.032
Gehäuse: Eiche Haken: Aluminium	Gehäuse: geölt Haken: poliert	844.25.040

Abpackung: 1 Stück

DGH-M 2018, HIDE-de, 06/18; Maßangaben unverbindlich. Konstruktionsänderungen vorbehalten.

1

Garderoben



- > Ausführung: Haken klappbar, Ausladung 47 mm
- > Befestigungsmaterial im Lieferumfang enthalten (Spanplattenschrauben Ø 4,0 x 40 mm und Dübel)

Werkstoff	Oberfläche	Artikel-Nr.
Gehäuse: Nussbaum Haken: Zinkdruckguss	Gehäuse: geölt Haken: verchromt poliert	844.26.600
Gehäuse: Eiche Haken: Aluminium	Gehäuse: geölt Haken: verchromt poliert	844.26.400

Abpackung: 1 Stück

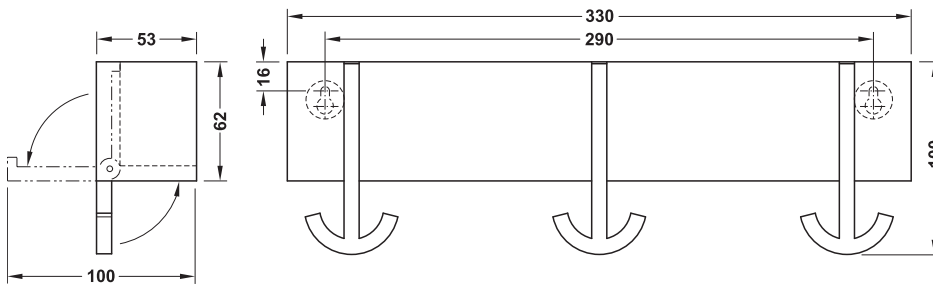

Garderobenbügel

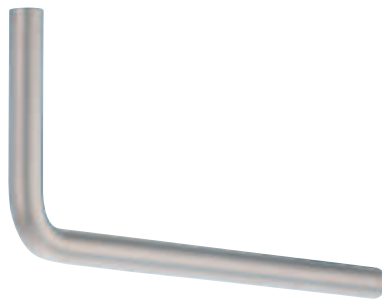

> Einsatzbereich: Montage unter dem Fachboden und gegen die Rückwand  
> Ausführung: Gewinde M4

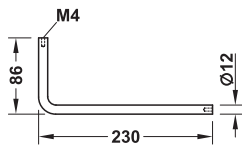

Oberfläche	Artikel-Nr.
verchromt matt	843.75.400
vernickelt matt	843.75.600

Abpackung: 1 oder 10 Stück



> Einsatzbereich: Montage unter dem Fachboden  
> Ausführung: Gewinde M4

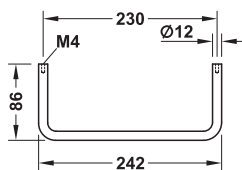

Oberfläche	Artikel-Nr.
verchromt matt	843.74.400
vernickelt matt	843.74.600

Abpackung: 1 oder 10 Stück

DGH-M 2018, HIDE-de, 06/18; Maßangaben unverbindlich. Konstruktionsänderungen vorbehalten.

Garderoben

Gewindeschrauben M4

► MB 1.470



1

Garderoben

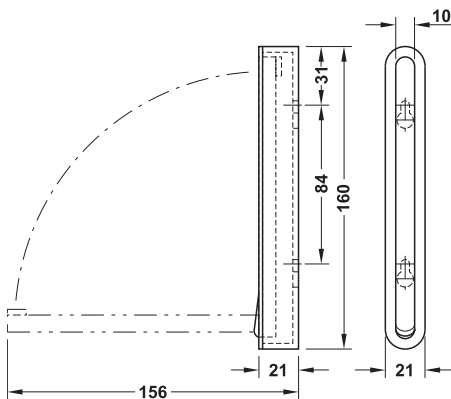

- > Werkstoff: Gehäuse: Kunststoff  
Haken: Zinkdruckguss
- > Ausführung: Haken klappbar,  
Zuhaltefunktion mit Magnet
- > Befestigungsmaterial im Lieferumfang enthalten  
(2 Schrauben 4,0 x 30 mm und 2 Dübel 6 mm)

Oberfläche/Farbe	Artikel-Nr.
Gehäuse: silberfarben, Haken: verchromt matt	844.23.900
Gehäuse: weiß, Haken: verchromt poliert	844.23.700
Gehäuse: schwarz, Haken: verchromt poliert	844.23.300

Abpackung: 1 oder 10 Stück

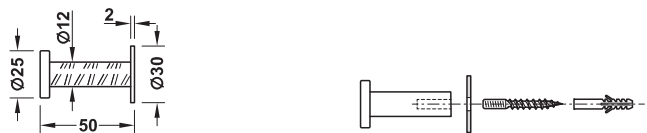
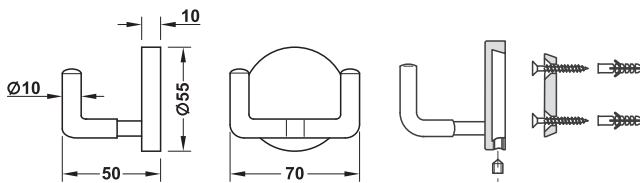
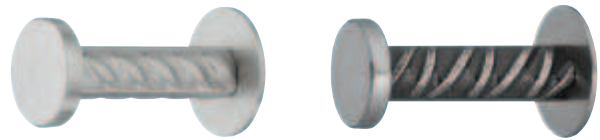
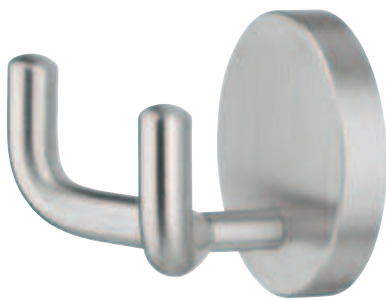

- > Werkstoff: Edelstahl, Güte 1.4305
- > Oberfläche: matt gebürstet
- > Lochabstand: 28 mm
- > Befestigungsmaterial im Lieferumfang enthalten (Spanplattenschrauben Ø 4,0 x 45 mm und Dübel)

- > Tiefe B: 50 mm
- > Haken-Durchmesser D: 12 mm
- > Rosetten-Durchmesser E: 30 mm
- > Befestigungsmaterial im Lieferumfang enthalten (Stockschraube M6 und Dübel)

Breite A mm	Tiefe B mm	Rosetten- Durchmesser E mm	Artikel-Nr.
70	50	55	842.59.090

Werkstoff	Oberfläche	Artikel-Nr.
Edelstahl, Güte 1.4571	matt gebürstet	842.58.090
Baustahl	roh lackiert, Used Look	842.59.100

Abpackung: 1 Stück

Abpackung: 1 Stück

Bügelgriff Edelstahl in Baustahl-Optik	► MB 1.42
Bogengriff Edelstahl in Baustahl-Optik	► MB 1.36
Möbelknopf Edelstahl in Baustahl-Optik	► MB 1.120
Garderobenbügel Edelstahl in Baustahl-Optik	► MB 1.368
Bügelgriff Stahl in Baustahl-Optik	► MB 1.42
Bogengriff Stahl in Baustahl-Optik	► MB 1.36
Möbelknopf Stahl in Baustahl-Optik	► MB 1.120
Garderobenbügel Stahl in Baustahl-Optik	► MB 1.368

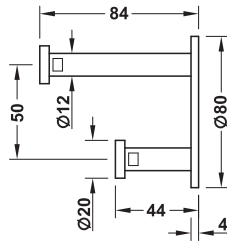

- > Werkstoff: Edelstahl, Güte 1.4305
- > Oberfläche: matt gebürstet
- > Befestigungsmaterial im Lieferumfang enthalten (Spanplattenschrauben Ø 3,5 x 40 mm)

Tiefe B mm	Haken- Durchmesser D mm	Rosetten- Durchmesser E mm	Artikel-Nr.
84	12	80	844.71.000

Abpackung: 1 Stück

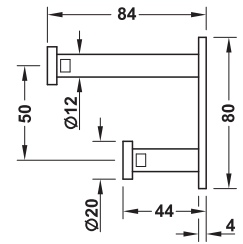
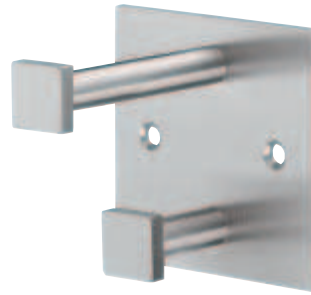

- > Werkstoff: Edelstahl, Güte 1.4305
- > Oberfläche: matt gebürstet
- > Befestigungsmaterial im Lieferumfang enthalten (Spanplattenschrauben Ø 3,5 x 40 mm)

Tiefe B mm	Haken- Durchmesser D mm	Querschnitt mm	Artikel-Nr.
84	12	Rosette 80 x 80	844.71.002

Abpackung: 1 Stück

## Garderobenhaken – Topco

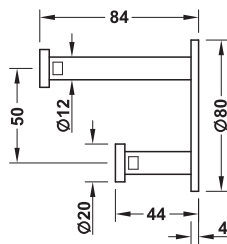

- > Werkstoff: Edelstahl, Güte 1.4305
- > Oberfläche: matt gebürstet
- > Befestigungsmaterial (Stockschraube M6 x 50 mm und Dübel) im Lieferumfang enthalten

Tiefe B mm	Haken- Durchmesser D mm	Rosetten- Durchmesser E mm	Artikel-Nr.
84	12	80	844.71.001

Abpackung: 1 Stück

**topCo** KUNDENINDIVIDUELL  
BEREITS AB EINEM STÜCK

Der Garderobenhaken ist auch mit einer Logo-Beschriftung auf den Kappen oder auf der Platte erhältlich.

Laser-Beschriftung

► MB 1.206

## Garderobenhaken – Topco

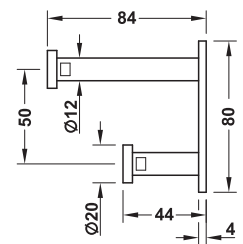
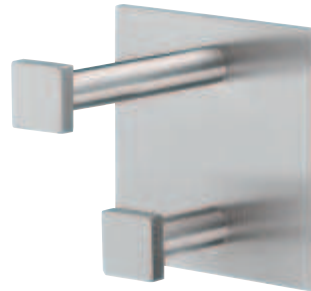

- > Werkstoff: Edelstahl, Güte 1.4305
- > Oberfläche: matt gebürstet
- > Befestigungsmaterial (Stockschraube M6 x 50 mm und Dübel) im Lieferumfang enthalten

Tiefe B mm	Haken- Durchmesser D mm	Querschnitt mm	Artikel-Nr.
84	12	Rosette 80 x 80	844.71.003

Abpackung: 1 Stück

**topCo** KUNDENINDIVIDUELL  
BEREITS AB EINEM STÜCK

Der Garderobenhaken ist auch mit einer Logo-Beschriftung auf den Kappen oder auf der Platte erhältlich.

Laser-Beschriftung

► MB 1.206

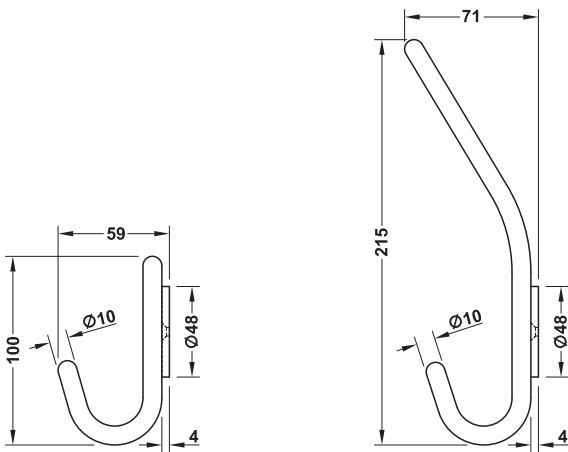

- > Werkstoff: Edelstahl, Güte 1.4305
- > Oberfläche: matt gebürstet
- > Lochabstand: 32 mm
- > Befestigungsmaterial im Lieferumfang enthalten (Spanplattenschrauben Ø 3,5 x 40 mm)

Tiefe B mm	Höhe C mm	Artikel-Nr.
<b>Mantelhaken</b>		
59	100	842.33.060
<b>Hut- und Mantelhaken</b>		
71	215	842.33.010

Abpackung: 1 Stück

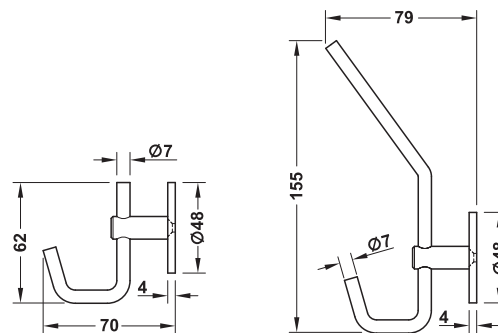
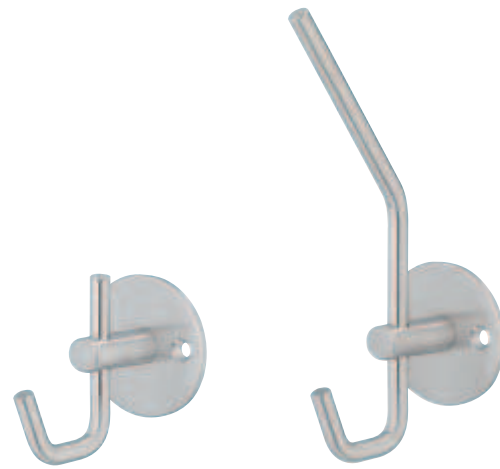

- > Werkstoff: Edelstahl, Güte 1.4305
- > Oberfläche: matt gebürstet
- > Lochabstand: 32 mm
- > Befestigungsmaterial im Lieferumfang enthalten (Spanplattenschrauben Ø 3,5 x 40 mm)

Tiefe B mm	Höhe C mm	Artikel-Nr.
<b>Mantelhaken</b>		
70	62	842.32.060
<b>Hut- und Mantelhaken</b>		
79	155	842.32.010

Abpackung: 1 Stück

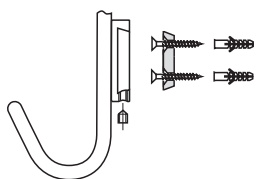
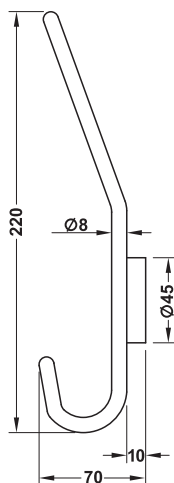
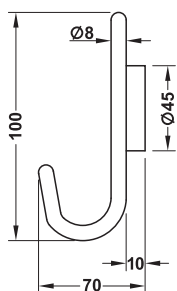

- > Werkstoff: Edelstahl, Güte 1.4305
- > Oberfläche: matt gebürstet
- > Lochabstand: 17 mm
- > Befestigungsmaterial im Lieferumfang enthalten (Spanplattenschrauben  $\varnothing$  4,0 x 45 mm und Dübel)

Höhe C mm	Artikel-Nr.
Mantelhaken	
100	842.35.060
Hut- und Mantelhaken	
220	842.35.010

Abpackung: 1 Stück

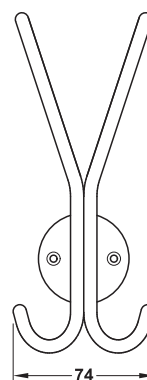
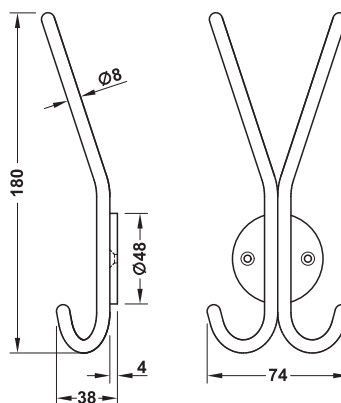
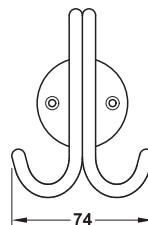
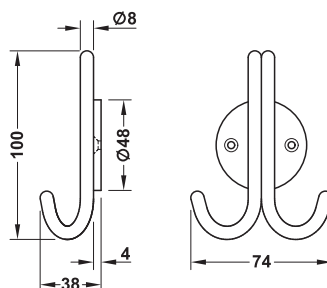
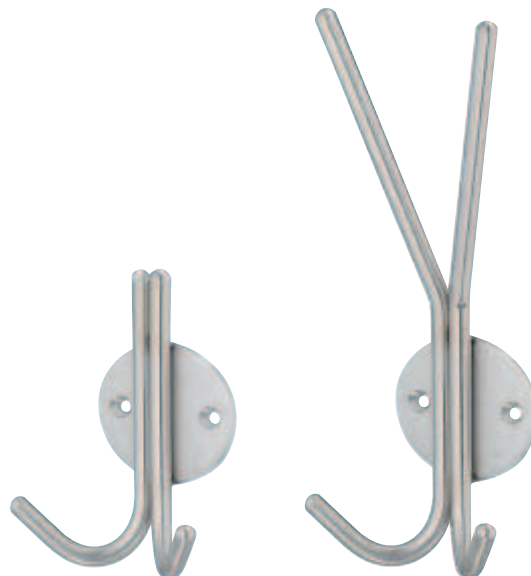

- > Werkstoff: Edelstahl, Güte 1.4305
- > Oberfläche: matt gebürstet
- > Lochabstand: 32 mm
- > Befestigungsmaterial im Lieferumfang enthalten (Spanplattenschrauben  $\varnothing$  3,5 x 40 mm)

Breite A mm	Tiefe B mm	Höhe C mm	Haken- Durch- messer D mm	Rosetten- Durch- messer E mm	Artikel-Nr.
Mantelhaken					
74	38	100	8	48	842.32.070
Hut- und Mantelhaken					
74	38	180	8	48	842.32.020

Abpackung: 1 Stück

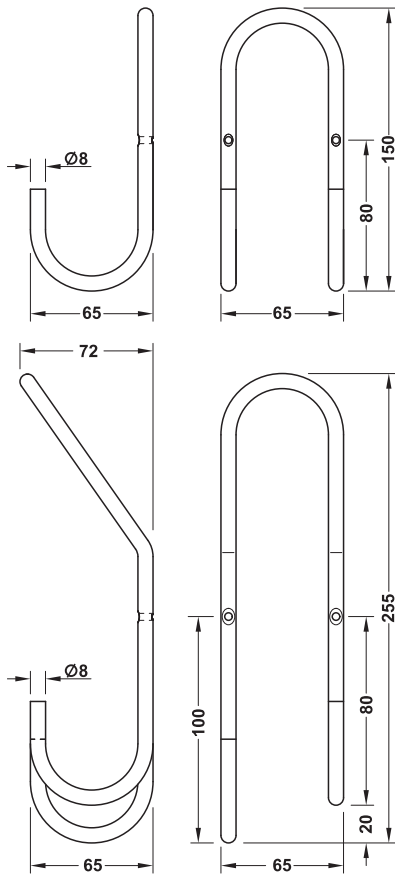

- > Werkstoff: Edelstahl, Güte 1.4305
- > Oberfläche: matt gebürstet
- > Lochabstand: 57 mm
- > Befestigungsmaterial im Lieferumfang enthalten (Spanplattenschrauben Ø 3,5 x 40 mm)

Breite A mm	Tiefe B mm	Höhe C mm	Artikel-Nr.
<b>Mantelhaken</b>			
65	65	150	842.35.050
<b>Hut- und Mantelhaken</b>			
65	65	255	842.35.000

Abpackung: 1 Stück

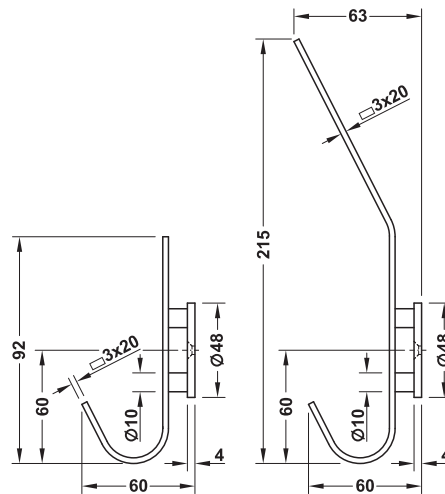

- > Werkstoff: Edelstahl, Güte 1.4301/1.4305
- > Oberfläche: matt gebürstet
- > Lochabstand: 32 mm
- > Befestigungsmaterial im Lieferumfang enthalten (Spanplattenschrauben Ø 3,5 x 40 mm)

Tiefe B mm	Höhe C mm	Querschnitt mm	Rosetten-Durchmesser E mm	Artikel-Nr.
<b>Mantelhaken</b>				
60	92	20 x 3	48	842.57.080
<b>Hut- und Mantelhaken</b>				
63	215	20 x 3	48	842.57.070

Abpackung: 1 Stück

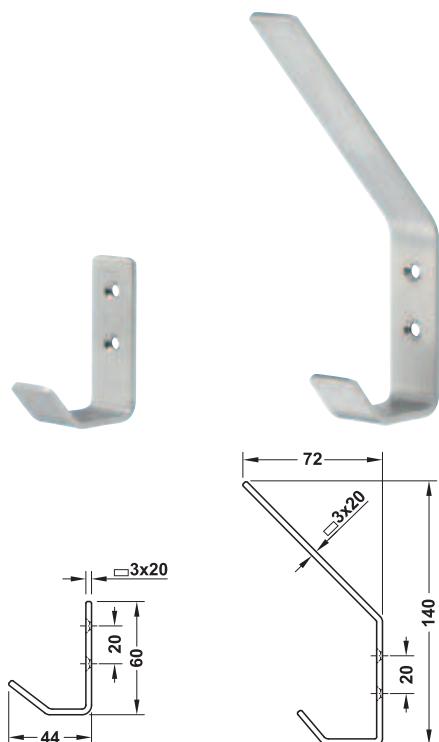

- > Werkstoff: Edelstahl, Güte 1.4301
- > Oberfläche: matt gebürstet
- > Befestigungsmaterial im Lieferumfang enthalten (Spanplattenschrauben Ø 3,5 x 40 mm)

Breite A mm	Tiefe B mm	Höhe C mm	Artikel-Nr.
<b>Mantelhaken</b>			
20	44	60	842.34.050
<b>Hut- und Mantelhaken</b>			
20	72	140	842.34.000

Abpackung: 1 Stück

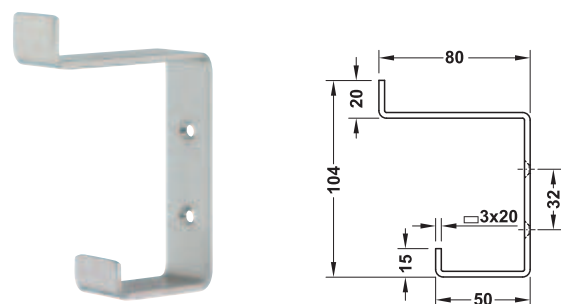

- > Werkstoff: Edelstahl, Güte 1.4301
- > Oberfläche: matt gebürstet
- > Befestigungsmaterial im Lieferumfang enthalten (Spanplattenschrauben Ø 3,5 x 40 mm)

Breite A mm	Tiefe B mm	Höhe C mm	Artikel-Nr.
20	80	104	842.34.020

Abpackung: 1 Stück

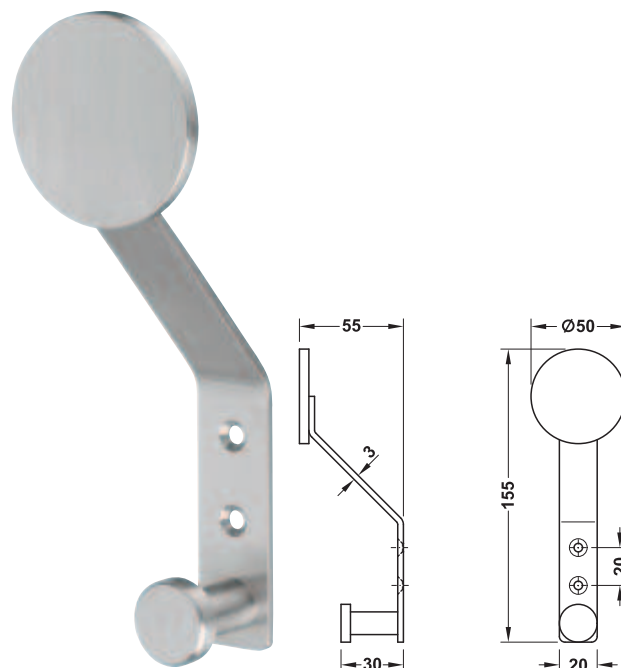

- > Werkstoff: Edelstahl, Güte 1.4305
- > Oberfläche: matt gebürstet
- > Befestigungsmaterial im Lieferumfang enthalten (Spanplattenschrauben Ø 3,5 x 40 mm)

Breite A mm	Tiefe B mm	Höhe C mm	Artikel-Nr.
20	55	155	844.70.000

Abpackung: 1 Stück

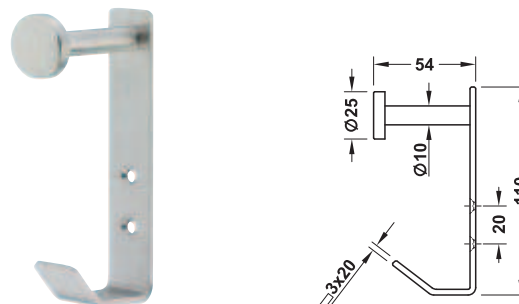

- > Werkstoff: Edelstahl, Güte 1.4305
- > Oberfläche: matt gebürstet
- > Befestigungsmaterial im Lieferumfang enthalten (Spanplattenschrauben Ø 3,5 x 40 mm)

Breite A mm	Tiefe B mm	Höhe C mm	Artikel-Nr.
20	54	110	842.34.010

Abpackung: 1 Stück



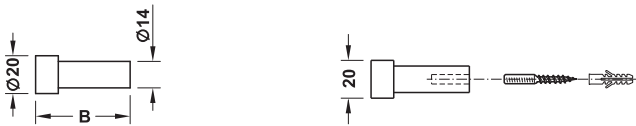
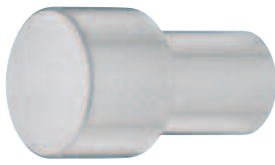

- > Werkstoff: Edelstahl, Güte 1.4305
- > Befestigungsmaterial (Stockschraube M6 x 50 mm und Dübel) im Lieferumfang enthalten

Oberfläche	Tiefe B mm	Artikel-Nr.
matt gebürstet	30	844.72.010
	50	844.72.011

Abpackung: 1 Stück

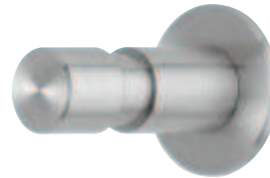

- > Werkstoff: Edelstahl, Güte 1.4301
- > Befestigungsmaterial (Stockschraube M6 x 50 mm und Dübel) im Lieferumfang enthalten

Oberfläche	Artikel-Nr.
matt	844.72.000

Abpackung: 1 Stück

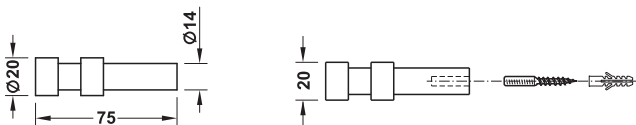
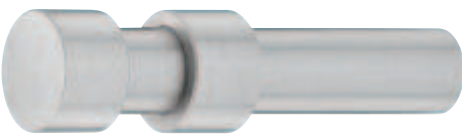

- > Werkstoff: Edelstahl, Güte 1.4305
- > Befestigungsmaterial (Stockschraube M6 x 50 mm und Dübel) im Lieferumfang enthalten

Oberfläche	Artikel-Nr.
matt gebürstet	844.72.020

Abpackung: 1 Stück

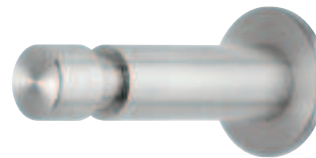

- > Werkstoff: Edelstahl, Güte 1.4301
- > Befestigungsmaterial (Stockschraube M6 x 50 mm und Dübel) im Lieferumfang enthalten

Oberfläche	Artikel-Nr.
matt	844.72.001

Abpackung: 1 Stück

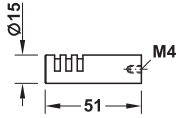

- > Werkstoff: Edelstahl, Güte 1.4305
- > Oberfläche: matt gebürstet
- > Ausführung: Gewinde M4

Tiefe B mm	Haken-Durchmesser D mm	Artikel-Nr.
51	15	842.58.000

Abpackung: 1 Stück

Gewindeschrauben M4 ▶ MB 1.470

### Garderobenhaken – Topco

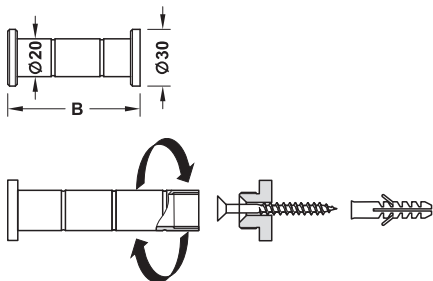

- > Werkstoff: Edelstahl, Güte 1.4305
- > Oberfläche: matt gebürstet
- > Befestigungsmaterial im Lieferumfang enthalten (Spanplattenschraube Ø 6,0 x 60 mm und Dübel)

Tiefe B mm	Haken-Durchmesser D mm	Artikel-Nr.
50	20	842.44.005
70	20	842.44.007
100	20	842.44.000

Abpackung: 1 Stück

**topCo** KUNDENINDIVIDUELL  
BEREITS AB EINEM STÜCK

Der Garderobenhaken ist auch mit einer Logo-Beschriftung auf der Kappe erhältlich.

Laser-Beschriftung ▶ MB 1.206

### Garderobenhaken – Topco

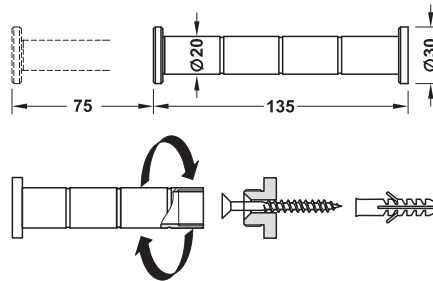

- > Werkstoff: Edelstahl, Güte 1.4305
- > Oberfläche: matt gebürstet
- > Auszugslänge AL: 75 mm
- > Befestigungsmaterial im Lieferumfang enthalten (Spanplattenschraube Ø 6,0 x 60 mm und Dübel)

Tiefe B mm	Haken-Durchmesser D mm	Artikel-Nr.
135	20	842.44.013

Abpackung: 1 Stück

**topCo** KUNDENINDIVIDUELL  
BEREITS AB EINEM STÜCK

Der Garderobenhaken ist auch mit einer Logo-Beschriftung auf der Kappe erhältlich.

Laser-Beschriftung ▶ MB 1.206

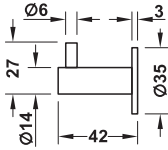
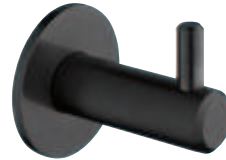
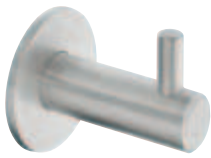

> Werkstoff: Edelstahl  
> Befestigungsmaterial im Lieferumfang enthalten (Stockschraube M6 x 38 mm)

Oberfläche/Farbe	Abpackung Stück	Artikel-Nr.
matt gebürstet	1 oder 25	844.28.100
vermessingt poliert, PVD beschichtet	1 oder 10	844.28.101
schwarz, matt, PVD beschichtet	1 oder 10	844.28.102

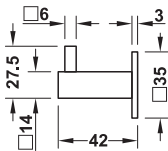
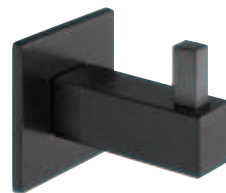
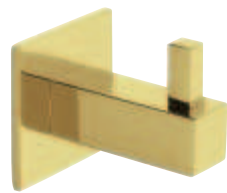
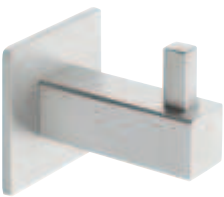

> Werkstoff: Edelstahl  
> Befestigungsmaterial im Lieferumfang enthalten (Stockschraube M6 x 38 mm)

Oberfläche/Farbe	Abpackung Stück	Artikel-Nr.
matt gebürstet	1 oder 25	844.28.110
vermessingt poliert, PVD beschichtet	1 oder 10	844.28.111
schwarz, matt, PVD beschichtet	1 oder 10	844.28.112

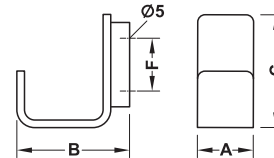
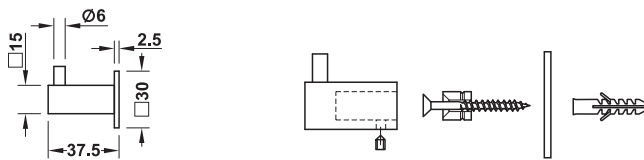

- > Werkstoff: Edelstahl, Güte 1.4305
- > Befestigungsmaterial im Lieferumfang enthalten (Spannplattenschraube Ø 4,0 x 60 mm und Dübel)

- > Werkstoff: Edelstahl, Güte 1.4301 und 1.4305

Oberfläche/ Farbe	Tiefe B mm	Stift- Durch- messer mm	Querschnitt mm	Artikel-Nr.
matt gebürstet	37,5	6	Rosette 30 x 30, Haken 15 x 15	842.57.020
schwarz matt, RAL 9017	37,5	6	Rosette 30 x 30, Haken 15 x 15	842.57.500

Abpackung: 1 Stück

Oberfläche	Breite A mm	Tiefe B mm	Höhe C mm	Loch- abstand F mm	Artikel-Nr.
gebürstet	30	50	60	28	842.35.030
gebürstet, geschwärzt	30	50	60	28	842.35.031

Abpackung: 1 Stück

Garderobenhaken aus Stahl

► MB 1.436

Spannplattenschraube Hospa Senkkopf Ø 4,5 mm ► MB 14.39

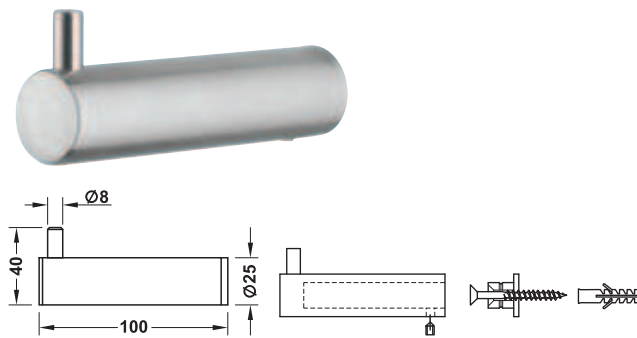

> Werkstoff: Edelstahl, Güte 1.4305  
 > Oberfläche: matt gebürstet  
 > Befestigungsmaterial im Lieferumfang enthalten (Spanplattenschraube Ø 6,0 x 60 mm und Dübel)

Tiefe B mm	Haken-Durchmesser D mm	Artikel-Nr.
100	25	844.77.001

Abpackung: 1 Stück

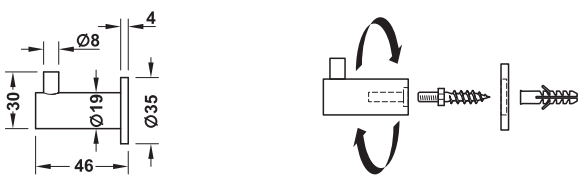

> Werkstoff: Edelstahl, Güte 1.4301/AISI 304  
 > Oberfläche: matt gebürstet  
 > Befestigungsmaterial (Stockschraube M6 x 36 mm und Dübel) im Lieferumfang enthalten

Tiefe B mm	Haken-Durchmesser D mm	Rosetten-Durchmesser E mm	Artikel-Nr.
46	19	35	842.57.010

Abpackung: 1 oder 20 Stück

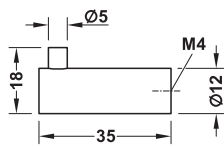
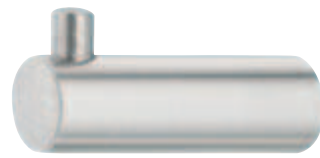

> Werkstoff: Edelstahl, Güte 1.4305  
 > Oberfläche: matt gebürstet

Tiefe B mm	Haken-Durchmesser D mm	Artikel-Nr.
35	12	942.10.000

Abpackung: 1 Stück

passendes Garderobenstangenset ▶ MB 1.403

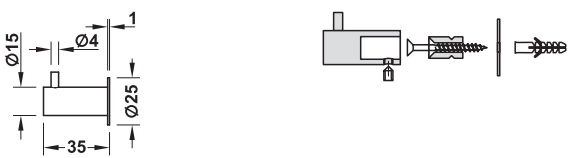
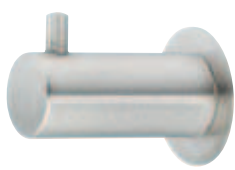

> Werkstoff: Edelstahl, Güte 1.4301/AISI 304  
 > Oberfläche: matt gebürstet  
 > Befestigungsmaterial im Lieferumfang enthalten (Spanplattenschraube Ø 4,0 x 60 mm und Dübel)

Tiefe B mm	Haken-Durchmesser D mm	Rosetten-Durchmesser E mm	Artikel-Nr.
35	15	25	855.00.015

Abpackung: 1 Stück

Gewindeschrauben M4 ▶ MB 1.470

DGH-M 2018, HDE-de, 06/18; Maßangaben unverbindlich. Konstruktionsänderungen vorbehalten.

Garderobenhaken

1

Garderobenhaken



- > Werkstoff: Edelstahl, Güte 1.4301
- > Oberfläche: matt gebürstet
- > Lochabstand: 36 mm
- > Befestigungsmaterial im Lieferumfang enthalten (2 Schrauben M4 x 40 mm und 2 Dübel)

Tiefe B mm	Haken- Durchmesser D mm	Rosetten- Durchmesser E mm	Artikel-Nr.
41	10	51	843.90.050

Abpackung: 1 oder 10 Stück

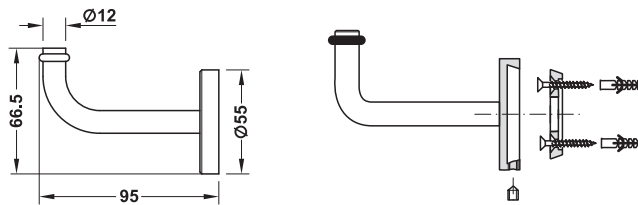

- > Werkstoff: Edelstahl, Güte 1.4305
- > Oberfläche: matt gebürstet
- > Lochabstand: 28 mm
- > Ausführung: mit Gummipuffer
- > Befestigungsmaterial im Lieferumfang enthalten (Spanplattenschrauben Ø 4,0 x 45 mm und Dübel)

Tiefe B mm	Haken- Durchmesser D mm	Rosetten- Durchmesser E mm	Artikel-Nr.
95	12	55	842.59.000

Abpackung: 1 Stück

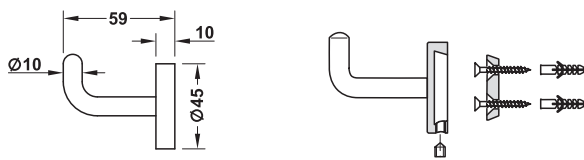

- > Werkstoff: Edelstahl, Güte 1.4305
- > Oberfläche: matt gebürstet
- > Lochabstand: 17 mm
- > Befestigungsmaterial im Lieferumfang enthalten (Spanplattenschrauben Ø 4,0 x 45 mm und Dübel)

Tiefe B mm	Haken- Durchmesser D mm	Rosetten- Durchmesser E mm	Artikel-Nr.
59	10	45	842.33.020

Abpackung: 1 Stück



- > Werkstoff: Edelstahl, Güte 1.4305
- > Oberfläche: matt gebürstet
- > Lochabstand: 28 mm
- > Befestigungsmaterial im Lieferumfang enthalten (Spanplattenschrauben Ø 4,0 x 45 mm und Dübel)

Breite A mm	Tiefe B mm	Rosetten- Durchmesser E mm	Artikel-Nr.
15	60	55	842.33.031

Abpackung: 1 Stück

DGH-M 2018; HDE-de, 06/18; Maßangaben unverbindlich. Konstruktionsänderungen vorbehalten.



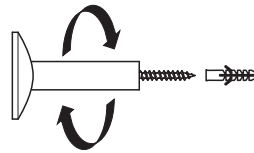
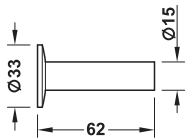

- > Werkstoff: Edelstahl, Güte 1.4305
- > Oberfläche: matt gebürstet
- > Befestigungsmaterial (Stockschraube M6 x 50 mm und Dübel) im Lieferumfang enthalten

Tiefe B mm	Haken-Durchmesser D mm	Artikel-Nr.
62	15	844.78.001

Abpackung: 1 Stück

Passender Möbelknopf ▶ MB 1.269

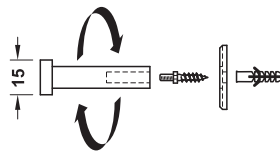
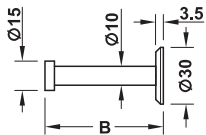

- > Werkstoff: Edelstahl, Güte 1.4301
- > Oberfläche: matt gebürstet
- > Ausführung: mit Rosette Ø 30 mm
- > Befestigungsmaterial (Stockschraube M6 x 60 mm und Dübel) im Lieferumfang enthalten

Tiefe B mm	Haken-Durchmesser D mm	Artikel-Nr.
32	10	844.72.030
52	10	844.72.031
72	10	844.72.032

Abpackung: 1 oder 10 Stück

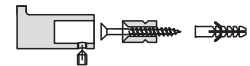
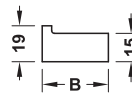

- > Werkstoff: Edelstahl, Güte 1.4301
- > Oberfläche: matt
- > Befestigungsmaterial im Lieferumfang enthalten

Breite A mm	Tiefe B mm	Höhe C mm	Artikel-Nr.
19	25	15	844.73.001
19	35	15	844.73.002

Abpackung: 1 oder 10 Stück



1

Garderobenhaken

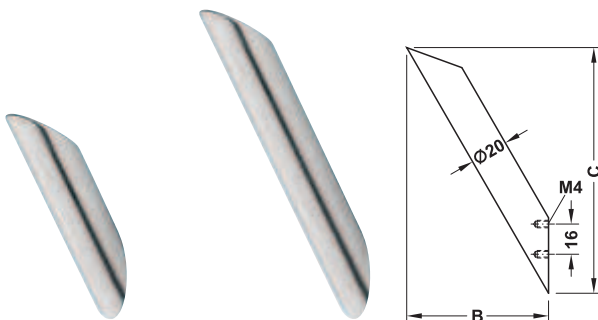
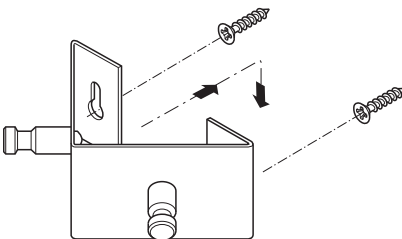
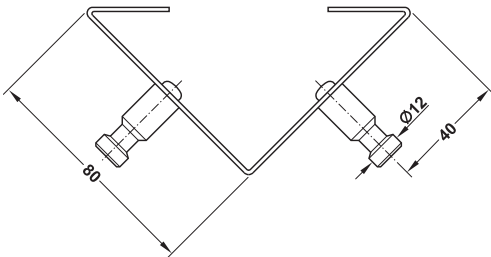
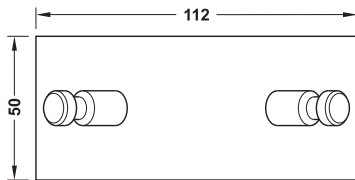
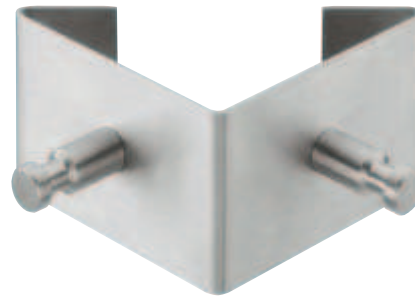

- > Werkstoff: Edelstahl, Güte 1.4301
- > Lochabstand: 85,3 mm
- > Befestigungsmaterial im Lieferumfang enthalten (Spanplattenschrauben Ø 4,0 x 45 mm und Dübel)

Breite mm	Tiefe mm	Höhe mm	Haken- Durchmesser mm	Artikel-Nr.
112	60	50	12	844.10.050

Abpackung: 1 Stück

- > Werkstoff: Edelstahl, Güte 1.4305
- > Oberfläche: matt gebürstet
- > Lochabstand: 16 mm
- > Ausführung: Gewinde M4

Tiefe B mm	Höhe C mm	Haken- Durchmesser D mm	Artikel-Nr.
43	100	20	843.91.011
64	150	20	843.91.012

Abpackung: 1 Stück

Gewindeschrauben M4

► MB 1.470

DGH-M 2018; HDE-de, 06/18; Maßangaben unverbindlich. Konstruktionsänderungen vorbehalten.

Drahhaken

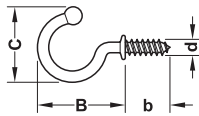

- > Ausführung: mit abgerundeter Spitze
- > Werkstoff: Edelstahl, Güte 1.4301/AISI 304
- > Oberfläche: poliert

Tiefe B mm	Höhe C mm	Durch- messer d mm	Gewinde- länge b mm	Ab- packung Stück	Artikel-Nr.
16,8	15	2,7	11	1 oder 200	856.00.003
22,8	20	2,7	11	1 oder 100	856.00.004
29,2	25	3,5	15	1 oder 50	856.00.005
40,5	34	4,5	20	1 oder 50	856.00.006

Schaukelhaken

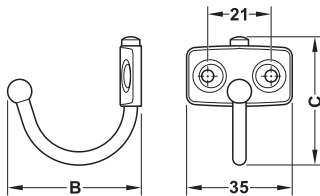

- > Ausführung: kraftschlüssig, schwenkbar um 180°
- > Werkstoff: Edelstahl, Güte 1.4301/AISI 304
- > Oberfläche: poliert
- > Lochabstand: 21 mm
- > Befestigungsmaterial im Lieferumfang enthalten (Spanplattenschrauben Ø 3,5 x 20 mm)

Breite A mm	Tiefe B mm	Höhe C mm	Artikel-Nr.
35	36	38	856.00.001
35	44,3	43	856.00.002

Abpackung: 1 oder 100 Stück

Drehbarer Schaukelhaken

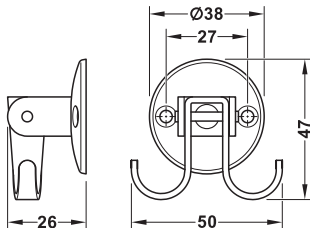

- > Einsatzbereich: auch als Deckenhaken geeignet, z.B. unter Bartischen
- > Ausführung: drehbar um 360°, schwenkbar um 180°
- > Werkstoff: Edelstahl, Güte 1.4301/AISI 304
- > Oberfläche: matt
- > Lochabstand: 27 mm
- > Rosetten-Durchmesser E: 38 mm
- > Befestigungsmaterial im Lieferumfang enthalten (Spanplattenschrauben Ø 3,0 x 25 mm)

Breite A mm	Tiefe B mm	Höhe C mm	Artikel-Nr.
50	26	47	856.00.000

Abpackung: 1 oder 25 Stück

DGH-M 2018, HIDE-de, 06/18; Maßangaben unverbindlich. Konstruktionsänderungen vorbehalten.

Garderobenhaken

**DIESE SEITE WURDE BEWUSST  
LEER GELASSEN**

**INTENTIONAL BLANK PAGE**

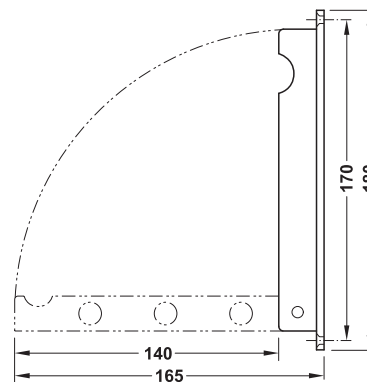
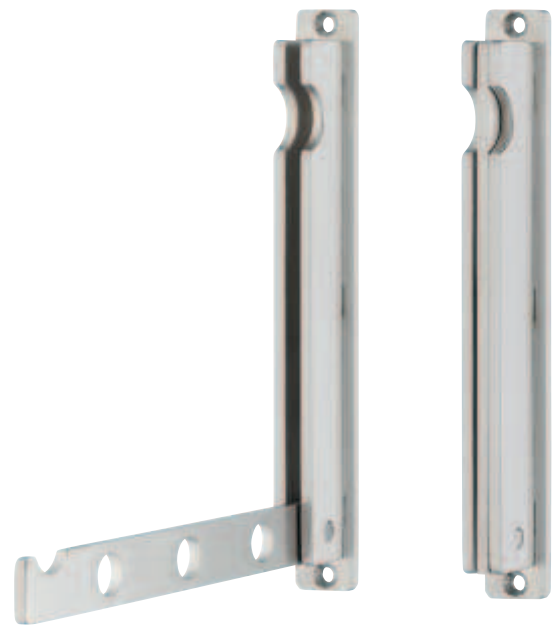

- > Werkstoff: Edelstahl, Güte 1.4301/AISI 304
- > Ausladung: 165 mm
- > Befestigungsmaterial im Lieferumfang enthalten (Spanplattenschrauben Ø 3,5 x 40 mm)

Oberfläche	Artikel-Nr.
matt gebürstet	844.21.010

Abpackung: 1 Stück

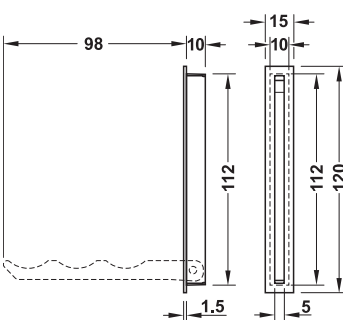

Mit der magnetischen Zuhaltfunktion eignet sich dieser Klapphaken auch für Zimmertüren.  
Bei Erschütterung der Tür bleibt der Haken im Gehäuse.



- > Werkstoff: Edelstahl, Güte 1.4301/AISI 304
- > Montage: schraubenlose Befestigung, zum Kleben
- > Ausführung: Zuhaltfunktion mit Magnet

Oberfläche	Artikel-Nr.
matt gebürstet	844.76.040

Abpackung: 1 oder 10 Stück

DGH-M 2018, HIDE-de, 06/18; Maßangaben unverbindlich. Konstruktionsänderungen vorbehalten.



Garderobenhaken geschlossen



Garderobenhaken ausgezogen

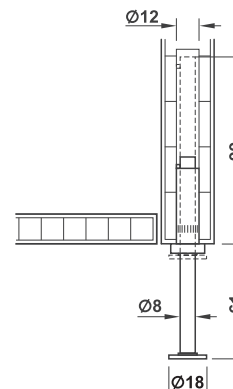
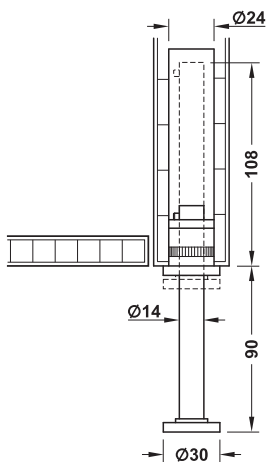
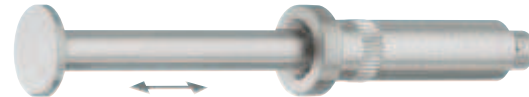
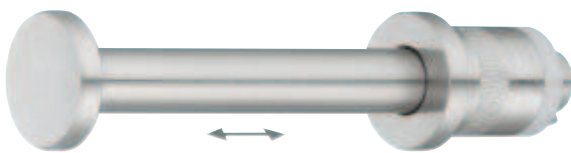

- > Werkstoff: Edelstahl, Güte 1.4305
- > Ausführung: ausziehbar
- > Montage: zum Kleben

- > Werkstoff: Edelstahl, Güte 1.4305
- > Ausführung: ausziehbar
- > Montage: zum Kleben

Oberfläche	Artikel-Nr.
matt gebürstet	842.58.010

Oberfläche	Artikel-Nr.
matt gebürstet	842.58.080

Abpackung: 1 Stück

Abpackung: 1 Stück

**Hinweis**

Zum Kleben empfehlen wir 2-K-Klebstoff Art.Nr. 003.03.024

Klapphaken



1

Garderobenhaken

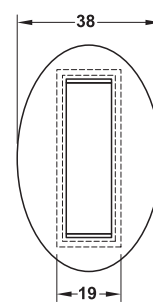
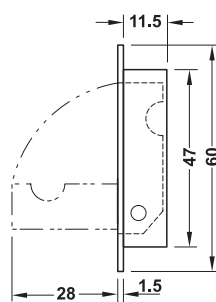
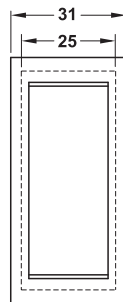
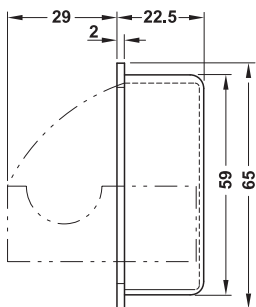

- > Werkstoff: Edelstahl, Güte 1.4305
- > Montage: schraubenlose Befestigung, zum Kleben

- > Werkstoff: Edelstahl, Güte 1.4305
- > Montage: schraubenlose Befestigung, zum Kleben
- > Ausführung: Zuhaltfunktion mit Magnet

Oberfläche	Artikel-Nr.
matt gebürstet	844.76.000

Abpackung: 1 Stück

Oberfläche	Artikel-Nr.
matt gebürstet	844.76.001

Abpackung: 1 Stück

DGH-M 2018, HDE-de, 06/18; Maßangaben unverbindlich. Konstruktionsänderungen vorbehalten.

1

Garderobenhaken

Klapphaken

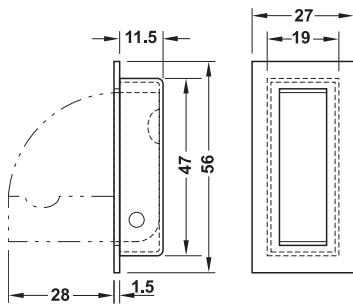
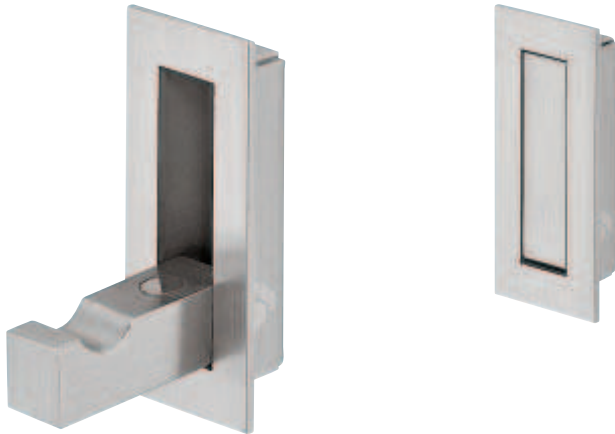

Mit der magnetischen Zuhaltfunktion eignet sich dieser Klapphaken auch für Zimmertüren.  
Bei Erschütterung der Tür bleibt der Haken im Gehäuse.



- > Werkstoff: Edelstahl, Güte 1.4305
- > Montage: schraubenlose Befestigung, zum Kleben
- > Ausführung: Zuhaltfunktion mit Magnet

Oberfläche	Artikel-Nr.
matt gebürstet	844.76.010

Abpackung: 1 oder 10 Stück

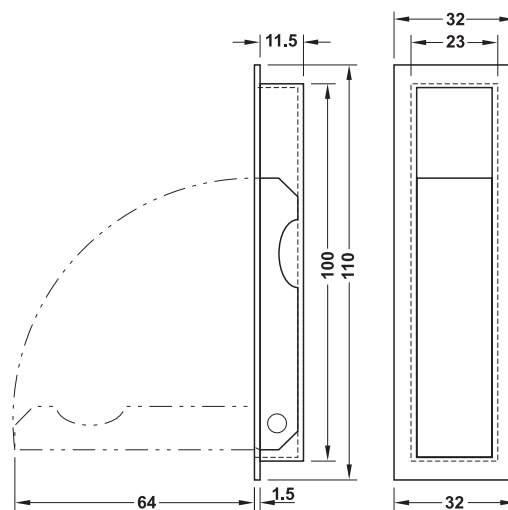

- > Werkstoff: Edelstahl, Güte 1.4305
- > Montage: schraubenlose Befestigung, zum Kleben
- > Ausführung: Zuhaltfunktion mit Feder

Oberfläche	Artikel-Nr.
matt gebürstet	844.76.020

Abpackung: 1 oder 10 Stück

DGH-M 2018; HDE-de, 06/18; Maßangaben unverbindlich. Konstruktionsänderungen vorbehalten.



Deckenhaken



1

Garderobenhaken

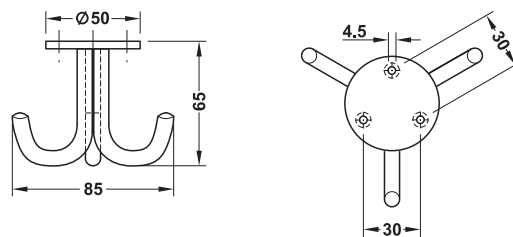
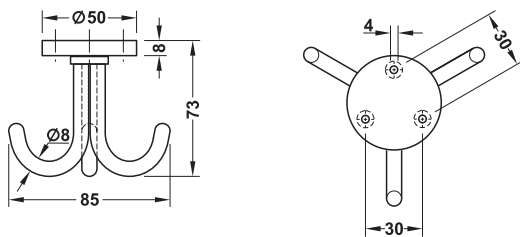

- > Werkstoff: Edelstahl
- > Ausführung: drehbar, Haken verschweißt
- > Befestigungsmaterial im Lieferumfang enthalten

- > Werkstoff: Edelstahl, Güte 1.4301/AISI 304
- > Ausführung: feststehend, Haken verschweißt
- > Befestigungsmaterial im Lieferumfang enthalten

Oberfläche	Artikel-Nr.
matt gebürstet	844.28.060

Oberfläche	Artikel-Nr.
matt gebürstet	855.00.010

Abpackung: 1 oder 10 Stück

Abpackung: 1, 40 oder 120 Stück

DGH-M 2018, HDE-de, 06/18; Maßangaben unverbindlich. Konstruktionsänderungen vorbehalten.

1

Garderobenhaken

Deckenhaken

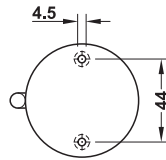
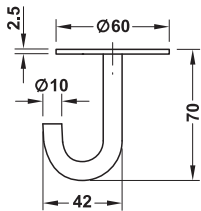

- > Werkstoff: Edelstahl, Güte 1.4301/AISI 304
- > Ausführung: feststehend, Haken verschweißt

Oberfläche	Artikel-Nr.
matt gebürstet	855.00.000

Abpackung: 1 Stück

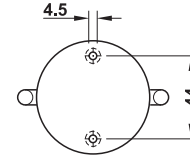
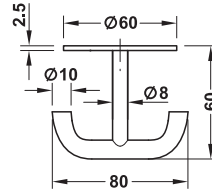

- > Werkstoff: Edelstahl, Güte 1.4301/AISI 304
- > Ausführung: feststehend, Haken verschweißt

Oberfläche	Artikel-Nr.
matt gebürstet	855.00.005

Abpackung: 1 Stück

Spanplattenschraube Hospa Ø 4,5 ▶ MB 13.19

Spanplattenschraube Hospa Ø 4,5 ▶ MB 13.19

DGH-M 2018, HDE-de, 06/18; Maßangaben unverbindlich. Konstruktionsänderungen vorbehalten.

Deckenhaken

1

Garderobenhaken

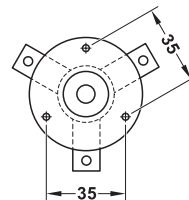
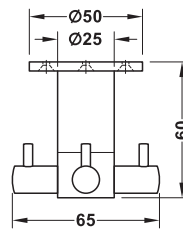
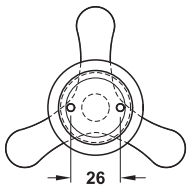
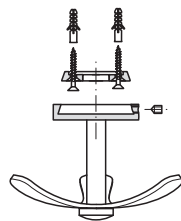
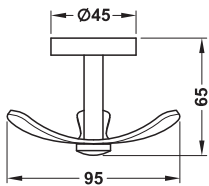
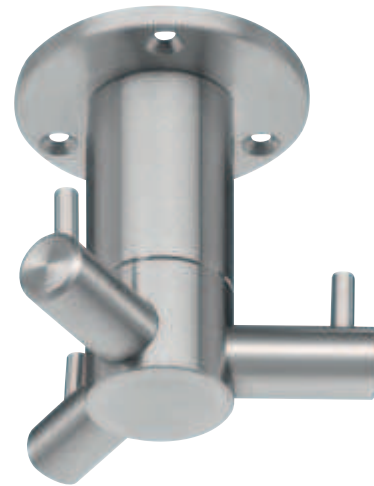

- > Werkstoff: Edelstahl, Güte 1.4305/AISI 303
- > Ausführung: drehbar
- > Befestigungsmaterial im Lieferumfang enthalten (Spanplattenschrauben Ø 4,0 x 45 mm und Dübel)

- > Werkstoff: Edelstahl, Güte 1.4305/AISI 303
- > Ausführung: drehbar
- > Befestigungsmaterial im Lieferumfang enthalten (Spanplattenschrauben Ø 4,5 x 20 mm)

Oberfläche	Artikel-Nr.
matt gebürstet	844.22.000

Abpackung: 1 Stück

Oberfläche/Farbe	Artikel-Nr.
matt gebürstet	844.28.005

Abpackung: 1 Stück

DGH-M 2018, HIDE-de, 06/18; Maßangaben unverbindlich. Konstruktionsänderungen vorbehalten.

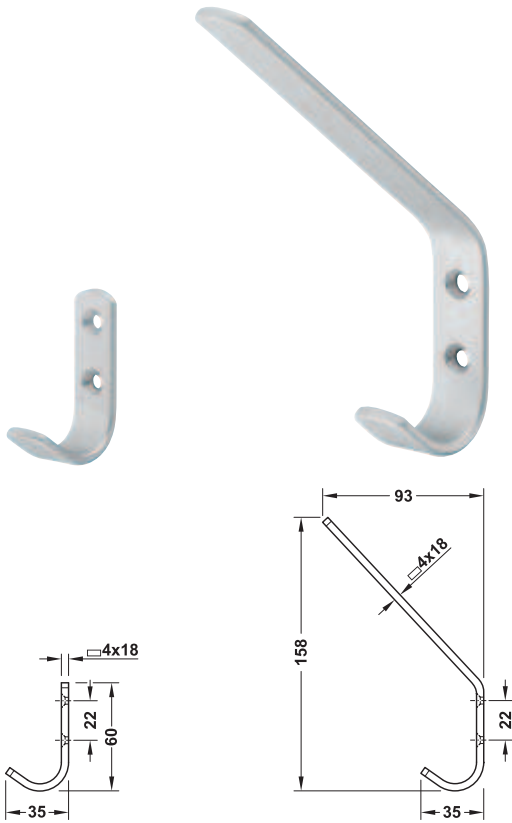

- > Lochabstand: 22 mm
- > Oberfläche: silberfarben eloxiert

Breite A mm	Tiefe B mm	Höhe C mm	Artikel-Nr.
<b>Mantelhaken</b>			
18	35	60	842.01.909
<b>Hut- und Mantelhaken</b>			
18	93	158	842.02.906

Abpackung: 1 oder 10 Stück

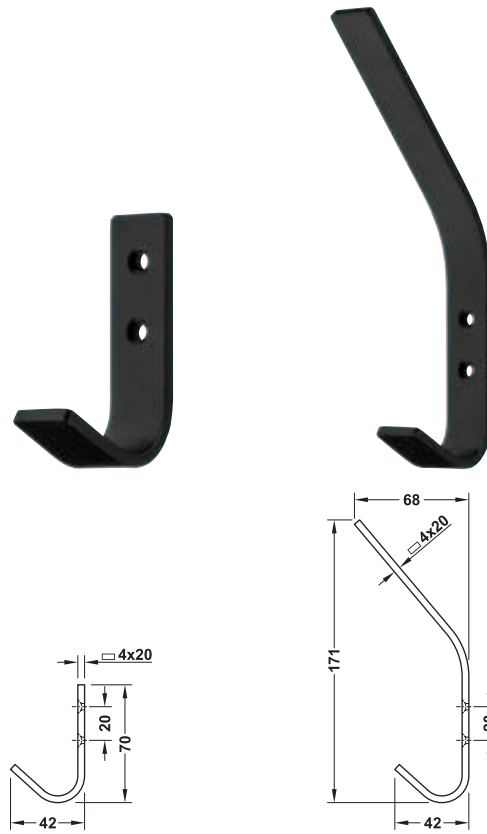

- > Lochabstand: 20 mm
- > Oberfläche: schwarz eloxiert

Breite A mm	Tiefe B mm	Höhe C mm	Artikel-Nr.
<b>Mantelhaken</b>			
20	42	70	844.61.011
<b>Hut- und Mantelhaken</b>			
20	42	171	844.61.010

Abpackung: 1 Stück

Linsensenkkopfschrauben Hospa Ø 4 mm

► MB 1.470

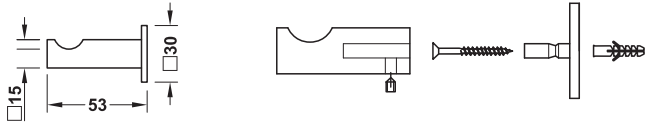

Oberfläche	Artikel-Nr.
schwarz eloxiert	844.61.013

Abpackung: 1 oder 10 Stück

Linsenkopfschrauben Hospa Ø 4 mm ▶ MB 1.470

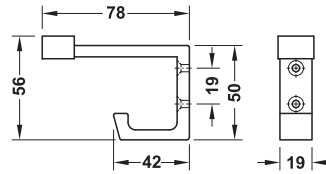
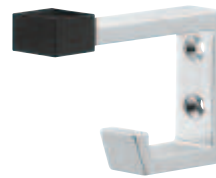

> Ausführung: Hut- und Mantelhaken mit Hartgummikappe

Oberfläche	Artikel-Nr.
silberfarben eloxiert	842.20.904

Abpackung: 1 oder 20 Stück

Linsenkopfschrauben Hospa Ø 4 mm ▶ MB 1.470



> Befestigungsmaterial (Stockschraube M8 x 50 mm und Dübel) im Lieferumfang enthalten

Oberfläche	Tiefe B mm	Artikel-Nr.
silberfarben eloxiert	38	844.60.001
	58	844.60.002
	83	844.60.003
schwarz eloxiert	38	844.61.012
	58	844.61.014
	83	844.61.015

Abpackung: 1 oder 10 Stück



silberfarben eloxiert



schwarz eloxiert

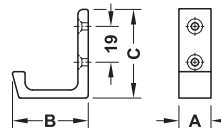

Oberfläche/Farbe	Breite A mm	Tiefe B mm	Höhe C mm	Abpackung Stück	Artikel-Nr.
silberfarben eloxiert	13	26	36	1 oder 100	842.20.960
	17	41	47	1 oder 20	842.20.959
	25	46,5	70	1 oder 20	842.20.971
schwarz eloxiert	13	26	36	1 oder 100	842.20.360
	17	41	47	1 oder 20	842.20.359
	25	46,5	70	1 oder 20	842.20.371

Linsenkopfschrauben Hospa Ø 4 mm ▶ MB 1.470

1

Garderobenhaken

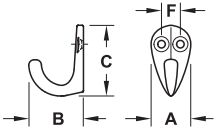

> Oberfläche: poliert

Breite A mm	Tiefe B mm	Höhe C mm	Lochabstand F mm	Schrauben-Durchmesser mm	Artikel-Nr.
<b>mit 1 Befestigungsloch</b>					
12	22	30	-	3,0	845.00.809
<b>mit 2 Befestigungslöchern</b>					
19	28	38	8	3,0	845.01.806
21	33	40	9	3,5	845.02.803

Abpackung: 1 oder 100 Stück

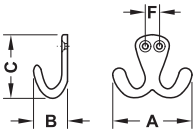

> Oberfläche: poliert

Breite A mm	Tiefe B mm	Höhe C mm	Lochabstand F mm	Schrauben-Durchmesser mm	Artikel-Nr.
42	22	32	7,5	3,0	845.10.805
49	25	40	9,0	3,0	845.11.802
60	30	50	12,5	3,5	845.12.809

Abpackung: 1 oder 100 Stück

## Deckenhaken

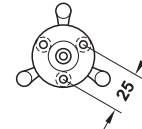
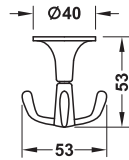

> Oberfläche: poliert  
> Ausführung: drehbar  
> Lochabstand: 25 mm

Breite A mm	Tiefe B mm	Höhe C mm	Artikel-Nr.
53	53	53	846.52.808

Abpackung: 1 oder 50 Stück

## Deckenhaken

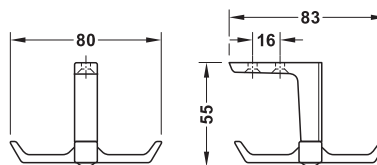
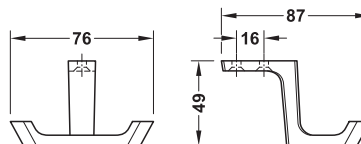

> Oberfläche: Aluminium silber eloxiert  
> Lochabstand: 16 mm

Ausführung	Breite A mm	Tiefe B mm	Höhe C mm	Artikel-Nr.
fest	76	87	49	844.43.900
drehbar	80	83	55	844.43.910

Abpackung: 1 oder 10 Stück

Linsensenkopfschrauben Hospa

► MB 1.470

DGH-M 2018; HDE-de, 06/18; Maßangaben unverbindlich. Konstruktionsänderungen vorbehalten.

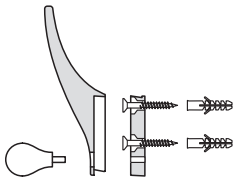
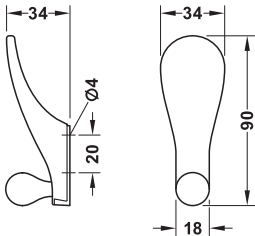

- > Designer: Jasper Morrison
- > Befestigungsmaterial ist im Lieferumfang enthalten (Spanplattenschrauben Ø 3,5 x 35 mm und Dübel)

Oberfläche/Farbe	Artikel-Nr.
silberfarben eloxiert	102.04.420
schwarz eloxiert	102.04.421
goldfarben eloxiert	102.04.422

Abpackung: 1 oder 10 Stück

DGH-M 2018, HIDE-de, 06/18; Maßangaben unverbindlich. Konstruktionsänderungen vorbehalten.



**DIESE SEITE WURDE BEWUSST  
LEER GELASSEN**

**INTENTIONAL BLANK PAGE**

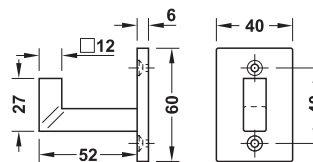
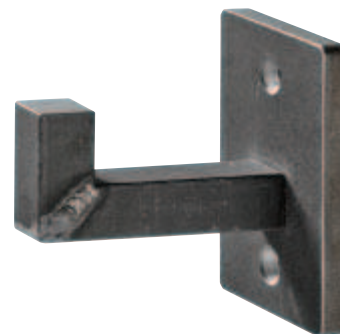
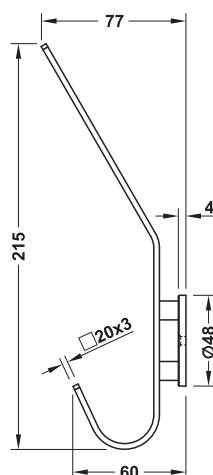
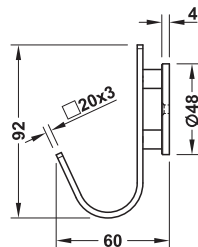

- > Werkstoff: Stahl
- > Befestigungsmaterial im Lieferumfang enthalten (schwarze Spanplattenschrauben Ø 3,5 x 40 mm, Dübel)

Oberfläche	Artikel-Nr.
matt lackiert	842.58.360

Abpackung: 1 oder 10 Stück

- > Werkstoff: Stahl
- > Lochabstand: 32 mm
- > Befestigungsmaterial im Lieferumfang enthalten (Spanplattenschrauben Ø 3,5 x 40 mm)

Tiefe B mm	Höhe C mm	Querschnitt mm	Rosetten- Durchmesser E mm	Artikel-Nr.
<b>Mantelhaken</b>				
60	92	20 x 3	48	842.58.040
<b>Hut- und Mantelhaken</b>				
77	215	20 x 3	48	842.58.030

Abpackung: 1 Stück

passender Griff	► MB 1.44
passender Knopf	► MB 1.121

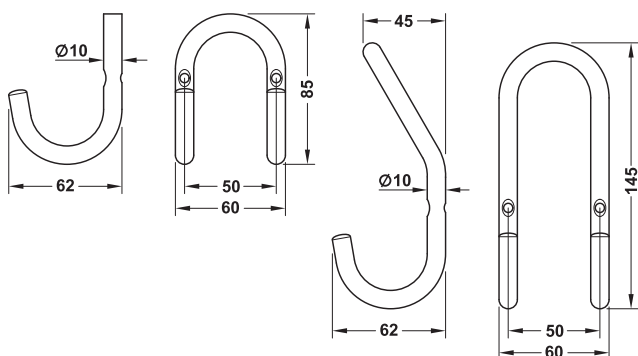

- > Oberfläche: aluminiumfarben
- > Befestigungsmaterial im Lieferumfang enthalten

Breite A mm	Tiefe B mm	Höhe C mm	Artikel-Nr.
<b>Mantelhaken</b>			
60	62	85	842.40.950
<b>Hut- und Mantelhaken</b>			
60	62	145	842.40.900

Abpackung: 1 oder 10 Stück

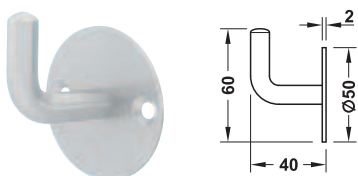

- > Oberfläche: aluminiumfarben
- > Lochabstand: 36 mm
- > Befestigungsmaterial im Lieferumfang enthalten

Tiefe B mm	Höhe C mm	Rosetten-Durchmesser E mm	Artikel-Nr.
40	60	50	842.40.980

Abpackung: 1 oder 10 Stück

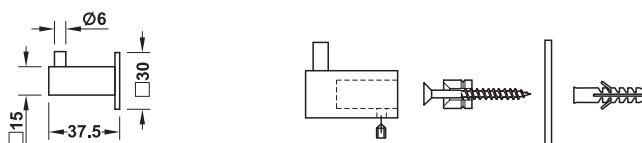
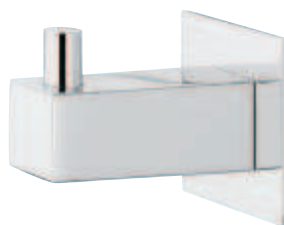

- > Oberfläche: verchromt poliert
- > Befestigungsmaterial im Lieferumfang enthalten (Spanplattenschraube Ø 4,0 x 60 mm und Dübel)

Tiefe B mm	Stift-Durchmesser mm	Querschnitt mm	Artikel-Nr.
37,5	6	Rosette 30 x 30, Haken 15 x 15	842.57.220

Abpackung: 1 Stück

Garderobenhaken aus Edelstahl

► MB 1.420



- > Lochabstand: 32 mm
- > Befestigungsmaterial im Lieferumfang enthalten

Oberfläche	Tiefe B mm	Rosetten-Durchmesser E mm	Artikel-Nr.
verchromt poliert	28	45	844.08.200
verchromt matt	28	45	844.08.400

Abpackung: 1 oder 20 Stück



- > Oberfläche: matt gebürstet
- > Lochabstand: 20 mm
- > Befestigungsmaterial im Lieferumfang enthalten (Spanplattenschrauben Ø 3,5 x 40 mm)

Breite A mm	Tiefe B mm	Höhe C mm	Artikel-Nr.
<b>Garderobenhaken</b>			
20	44	58	842.34.551
<b>Hut- und Mantelhaken</b>			
20	72	150	842.34.501

Abpackung: 1 Stück

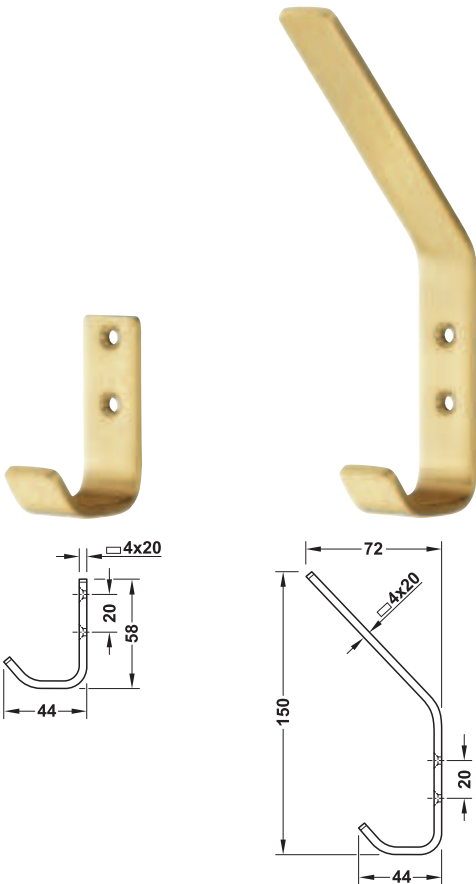

DGH-M 2018, HIDE-de, 06/18; Maßangaben unverbindlich. Konstruktionsänderungen vorbehalten.

passender Möbelgriff	► MB 1.166
passender Möbelknopf	► MB 1.274

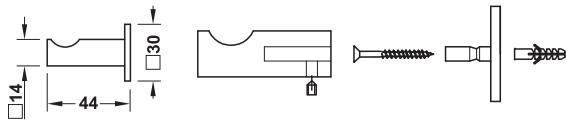
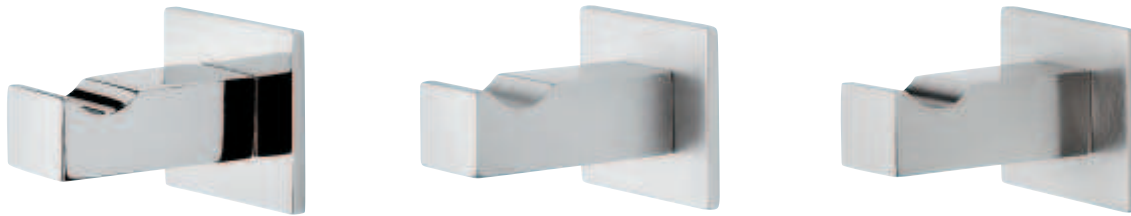

> Befestigungsmaterial im Lieferumfang enthalten

Oberfläche	Tiefe B mm	Artikel-Nr.
verchromt poliert	44	842.49.230
verchromt matt	44	842.49.430
edelstahlfarben	44	842.49.630

Abpackung: 1 oder 50 Stück

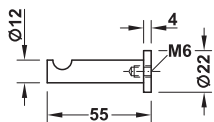

> Ausführung: mit eingedrehter Stockschraube (M6 x 60 mm) und Dübel

Oberfläche	Tiefe B mm	Haken- Durchmesser D mm	Rosetten- Durchmesser E mm	Artikel-Nr.
verchromt poliert	55	12	22	844.41.220
vernickelt matt	55	12	22	844.41.620
poliert	55	12	22	844.41.820

Abpackung: 1 Stück



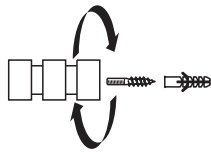
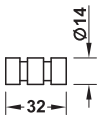
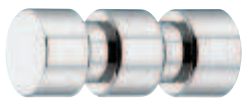

> Befestigungsmaterial im Lieferumfang enthalten

Oberfläche	Tiefe B mm	Artikel-Nr.
verchromt poliert	32	844.38.200

Abpackung: 1 oder 10 Stück

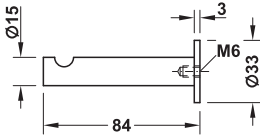

> Ausführung: mit eingedrehter Stockschraube (M6 x 60 mm) und Dübel

Oberfläche	Tiefe B mm	Haken-Durchmesser D mm	Rosetten-Durchmesser E mm	Artikel-Nr.
vernickelt matt	84	15	33	844.41.621

Abpackung: 1 Stück

DGH-M 2018, HIDE-de, 06/18; Maßangaben unverbindlich. Konstruktionsänderungen vorbehalten.

1

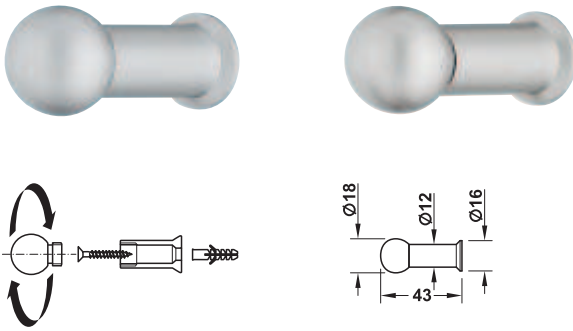

> Befestigungsmaterial im Lieferumfang enthalten

Oberfläche	Tiefe B mm	Haken- Durchmesser D mm	Artikel-Nr.
verchromt matt	43	12	842.49.420
vernickelt matt	43	12	842.49.620

Abpackung: 1 oder 100 Stück

Garderobenhaken

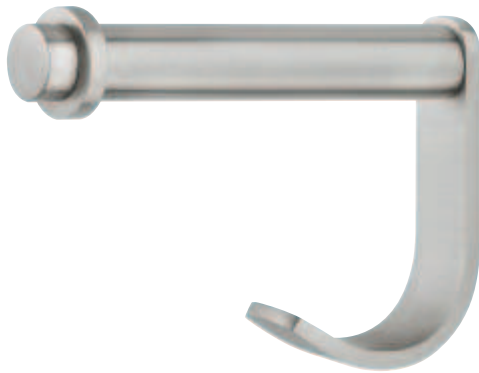

> Ausführung: mit eingedrehter Stockschraube (M6 x 60 mm) und Dübel

Oberfläche	Tiefe B mm	Höhe C mm	Haken- Durchmesser D mm	Artikel-Nr.
vernickelt matt	96	66	15	844.41.600

Abpackung: 1 Stück

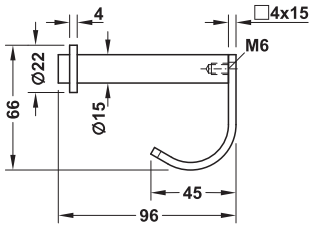



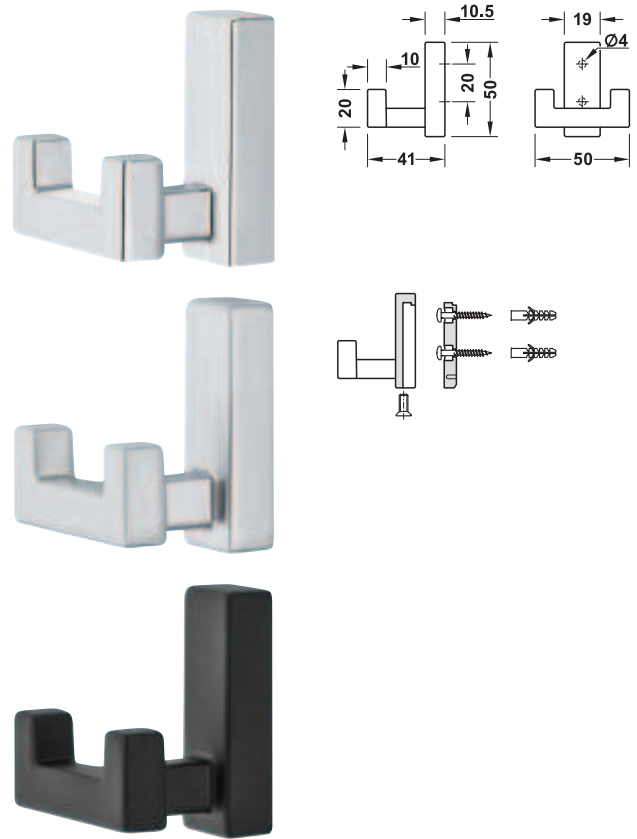
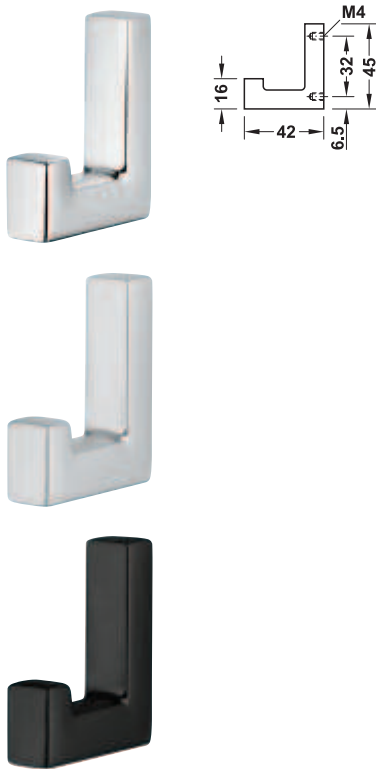

DGH-M 2018, HDE-de, 06/18; Maßangaben unverbindlich. Konstruktionsänderungen vorbehalten.

Oberfläche	Breite A mm	Tiefe B mm	Höhe C mm	Artikel-Nr.
verchromt poliert	10	42	45	844.27.200
verchromt matt	10	42	45	844.27.400
schwarz matt	10	42	45	844.27.005

Abpackung: 1 oder 10 Stück

passende Garderobenstange ▶ MB 1.442

Gewindeschrauben M4 ▶ MB 1.470

> Montage: von vorne, mit separatem Sockel

Oberfläche	Breite A mm	Tiefe B mm	Höhe C mm	Artikel-Nr.
verchromt poliert	50	41	50	844.27.001
verchromt matt	50	41	50	844.27.002
schwarz matt	50	41	50	844.27.000

Abpackung: 1, 10 oder 50 Stück

Spanplattenschrauben Hospa Senkkopf Ø 4,0 mm ▶ MB 1.470

1

Garderobenhaken

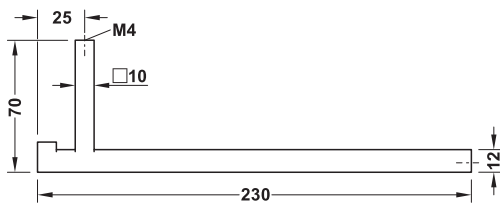

Oberfläche	Breite A mm	Tiefe B mm	Höhe C mm	Artikel-Nr.
verchromt poliert	230	70	10	844.27.011
schwarz matt	230	70	10	844.27.010

Abpackung: 1 oder 5 Stück

passender Garderobenhaken	► MB 1.441
Gewindeschrauben M4	► MB 1.470

DGH-M 2018; HDE-de, 06/18; Maßangaben unverbindlich. Konstruktionsänderungen vorbehalten.



Ideal auch als Schrankinnenaustattung.



1

Garderobenhaken



> Werkstoff: Haken: Zinkdruckguss, Abdeckkappe: Kunststoff

Oberfläche/Farbe	Artikel-Nr.
verchromt poliert	845.08.210

Abpackung: 1 oder 100 Stück

Spanplattenschrauben Hospa Senkkopf Ø 3,5 mm ► MB 1.470

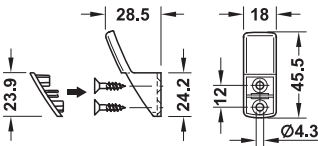

> Lochabstand: 10 mm  
> Befestigungsmaterial im Lieferumfang enthalten

Oberfläche/Farbe	Artikel-Nr.
verchromt matt	845.08.450
vernickelt gebürstet	845.08.650
schwarz matt	845.08.230

Abpackung: 1 oder 12 Stück

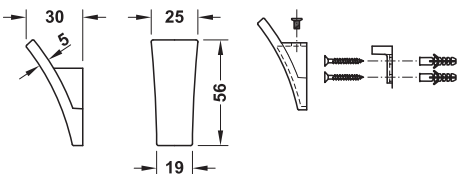

DGH-M 2018, HIDE-de, 06/18; Maßangaben unverbindlich. Konstruktionsänderungen vorbehalten.

1

Garderobenhaken

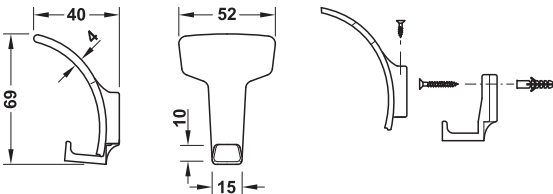

> Befestigungsmaterial im Lieferumfang enthalten

Oberfläche	Breite A mm	Tiefe B mm	Höhe C mm	Artikel-Nr.
edelstahlfarben	52	40	69	843.72.010

Abpackung: 1 oder 10 Stück

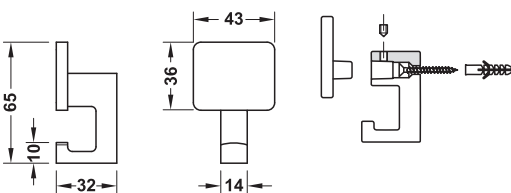

> Oberfläche: aluminiumfarben  
> Befestigungsmaterial im Lieferumfang enthalten

Breite A mm	Tiefe B mm	Höhe C mm	Artikel-Nr.
43	32	65	843.94.901

Abpackung: 1 oder 10 Stück

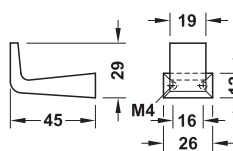
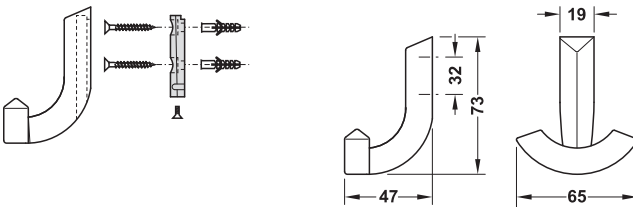
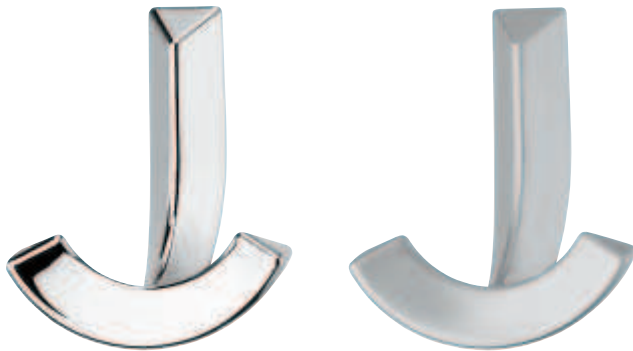
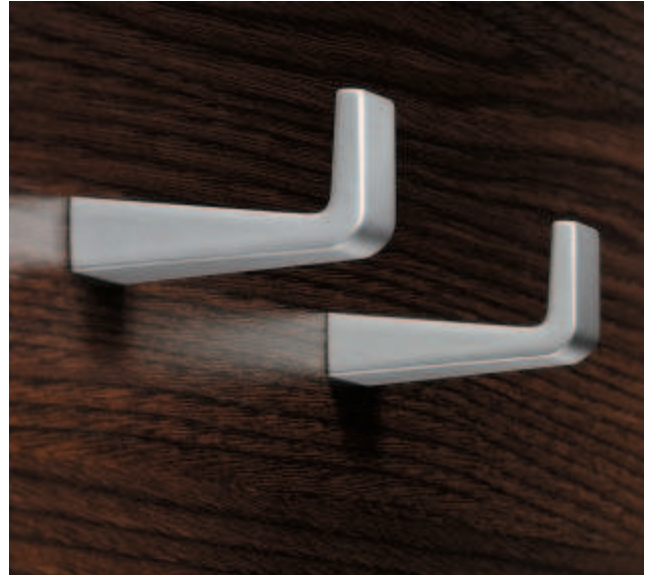

> Befestigungsmaterial im Lieferumfang enthalten  
(Panhead-Schrauben 4 x 30 mm und Dübel)

Oberfläche	Breite A mm	Tiefe B mm	Höhe C mm	Artikel-Nr.
verchromt poliert	65	47	73	844.27.220
verchromt matt	65	47	73	844.27.420

Abpackung: 1 oder 10 Stück

Oberfläche	Breite A mm	Tiefe B mm	Höhe C mm	Artikel-Nr.
verchromt matt	26	45	29	844.27.410

Abpackung: 1 oder 50 Stück

DGH-M 2018, HIDE-de, 06/18; Maßangaben unverbindlich. Konstruktionsänderungen vorbehalten.

Gewindeschrauben M4

► MB 1.470

1

Garderobenhaken

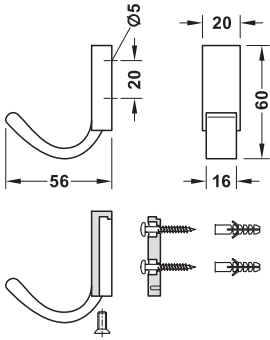

> Designer: August Schatte

Oberfläche/Farbe	Artikel-Nr.
verchromt poliert	102.04.230
schwarz	102.04.231
goldfarben	102.04.232

Abpackung: 1 oder 10 Stück

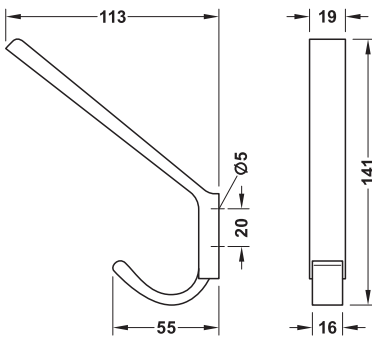

> Designer: August Schatte

Oberfläche/Farbe	Artikel-Nr.
verchromt poliert	102.04.240
schwarz	102.04.241
goldfarben	102.04.242

Abpackung: 1 oder 10 Stück

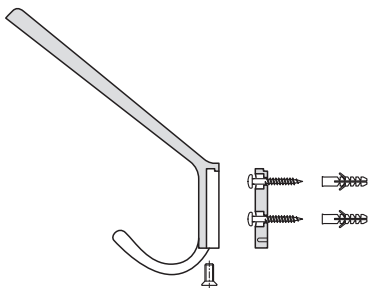

Spanplattenschrauben Hospa Senkkopf Ø 4,0 mm ► MB 1.470

DGH-M 2018; HDE-de, 06/18; Maßangaben unverbindlich. Konstruktionsänderungen vorbehalten.

**DIESE SEITE WURDE BEWUSST  
LEER GELASSEN**

**INTENTIONAL BLANK PAGE**



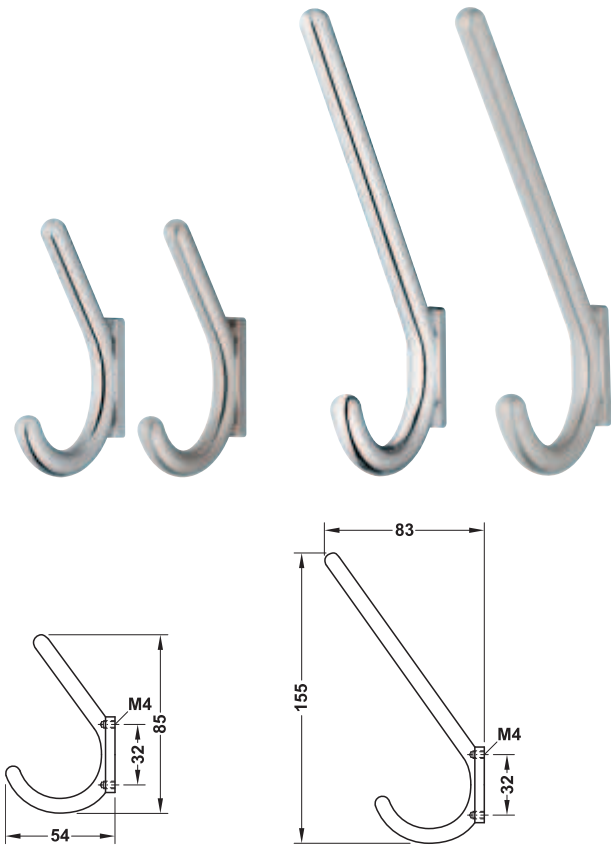

	Breite A mm	Tiefe B mm	Höhe C mm	Artikel-Nr.
<b>verchromt poliert</b>				
Mantelhaken	10	54	85	842.10.250
Hut- und Mantelhaken	12	83	155	842.10.200
<b>vernickelt matt</b>				
Mantelhaken	10	54	85	842.10.650
Hut- und Mantelhaken	12	83	155	842.10.600

Abpackung: 1 oder 10 Stück

Gewindeschrauben M4 ▶ MB 1.470

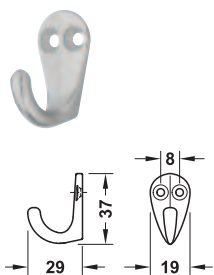

> Oberfläche: vernickelt

Breite A mm	Tiefe B mm	Höhe C mm	Artikel-Nr.
19	29	37	845.01.710

Abpackung: 1 oder 100 Stück

Linsensenkopfschrauben Hospa Ø 3,5 mm ▶ MB 1.470

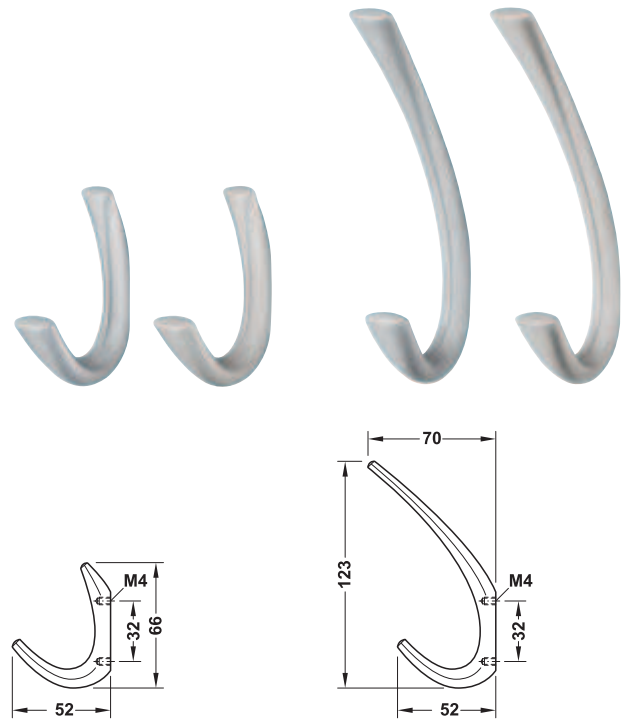

	Breite A mm	Tiefe B mm	Höhe C mm	Artikel-Nr.
<b>verchromt matt</b>				
Mantelhaken	16	52	66	842.28.450
Hut- und Mantelhaken	16	70	123	842.28.400
<b>vernickelt matt</b>				
Mantelhaken	16	52	66	842.28.650
Hut- und Mantelhaken	16	70	123	842.28.600

Abpackung: 1 oder 50 Stück

Gewindeschrauben M4 ▶ MB 1.470

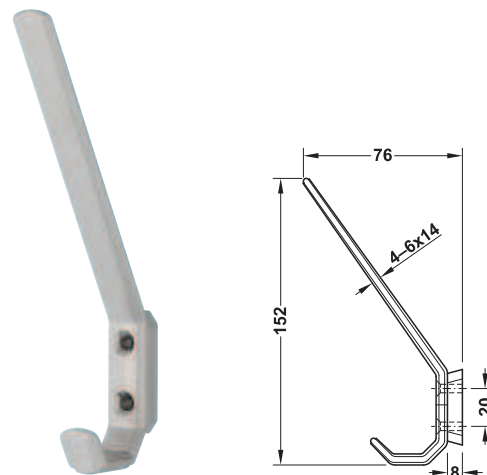

Oberfläche	Breite A mm	Tiefe B mm	Höhe C mm	Artikel-Nr.
vernickelt matt	14	76	152	842.12.600

Abpackung: 1 oder 10 Stück

Spanplattenschrauben Hospa Senkkopf Ø 4 mm ▶ MB 1.470

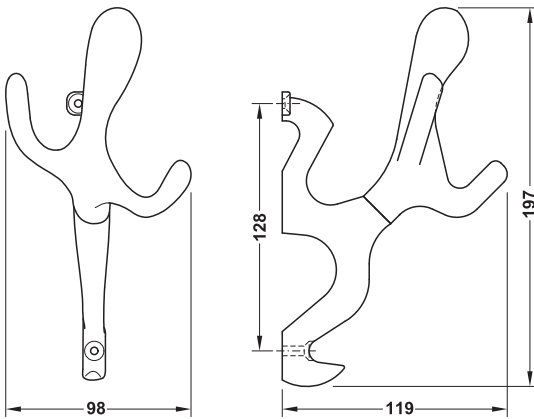
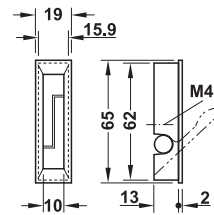

> Oberfläche: vernickelt matt

Breite A mm	Tiefe B mm	Höhe C mm	Artikel-Nr.
98	119	197	843.83.600

Abpackung: 1 Stück

Dieser Klapphaken kann auch als Möbelgriff verwendet werden. Beim Aufklappen zeigt der Haken nach unten. 

> Ausführung: Zuhaltfunktion mit Magnet  
> Montage: Gewinde M4

Oberfläche	Artikel-Nr.
verchromt matt	844.33.400
vernickelt matt	844.33.600

Abpackung: 1 oder 10 Stück

Garderobenhaken

DGH-M 2018, HIDE-de, 06/18; Maßangaben unverbindlich. Konstruktionsänderungen vorbehalten.

Spanplattenschrauben Hospa Senkkopf Ø 4 mm ▶ MB 1.470

Möbelgriff als Klapphaken ▶ MB 1.119

Gewindeschrauben M4 ▶ MB 1.470

16.05.2016  
ID 4282

1

Garderobenhaken

Klapphaken

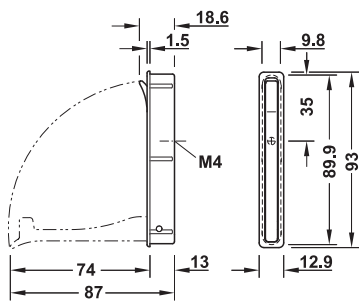
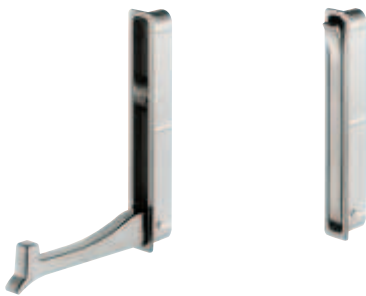

- > Ausführung: Zuhaltfunktion mit Magnet
- > Montage: zum Schrauben oder zum Kleben

Oberfläche	Artikel-Nr.
verchromt poliert	844.33.220
edelstahlfarben	844.33.020

Abpackung: 1 oder 5 Stück

Gewindeschrauben M4 ▶ MB 1.470

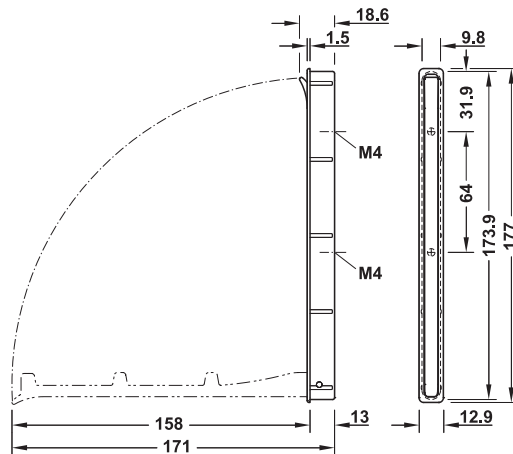

- > Ausführung: Zuhaltfunktion mit Magnet
- > Montage: zum Schrauben oder zum Kleben

Oberfläche	Artikel-Nr.
verchromt poliert	844.33.230
edelstahlfarben	844.33.030

Abpackung: 1 oder 10 Stück

Gewindeschrauben M4 ▶ MB 1.470

DGH-M 2018; HDE-de, 06/18; Maßangaben unverbindlich. Konstruktionsänderungen vorbehalten.

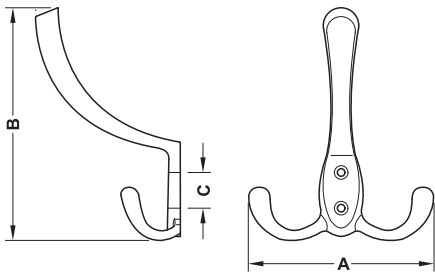

Oberfläche/Farbe	Maß A mm	Maß B mm	Maß C mm	Artikel-Nr.
durchgerieben, braun	75	123	20	855.00.020
vermessingt poliert	75	123	20	855.00.021
verchromt matt	75	123	20	855.00.022
verchromt poliert	75	123	20	855.00.023
verzinkt antik	75	123	20	855.00.024
vermessingt antik	75	123	20	855.00.025
antik, silberfarben	75	123	20	855.00.026
bronzefarben geölt dunkel	75	123	20	855.00.027
vermessingt gebürstet	75	123	20	855.00.028

Abpackung: 1 Stück

DGH-M 2018, HIDE-de, 06/18; Maßangaben unverbindlich. Konstruktionsänderungen vorbehalten.

Spanplattenschrauben Hospa Senkkopf Ø 4 mm ▶ MB 1.470

06.09.2019  
ID 4629

1



Garderobenhaken traditionell

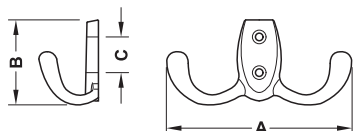

Oberfläche/Farbe	Maß A mm	Maß B mm	Maß C mm	Artikel-Nr.
durchgerieben, braun	76	46	20	855.00.030
vermessingt poliert	76	46	20	855.00.031
verchromt matt	76	46	20	855.00.032
verchromt poliert	76	46	20	855.00.033
verzinkt antik	76	46	20	855.00.034
vermessingt antik	76	46	20	855.00.035
antik, silberfarben	76	46	20	855.00.036
bronzefarben geölt dunkel	76	46	20	855.00.037
vermessingt gebürstet	76	46	20	855.00.038

Abpackung: 1 Stück

Spanplattenschrauben Hospa Senkkopf Ø 4 mm ► MB 1.470

DGH-M 2018; HDE-de, 06/18; Maßangaben unverbindlich. Konstruktionsänderungen vorbehalten.

**DIESE SEITE WURDE BEWUSST  
LEER GELASSEN**

**INTENTIONAL BLANK PAGE**

1

Garderobenhaken

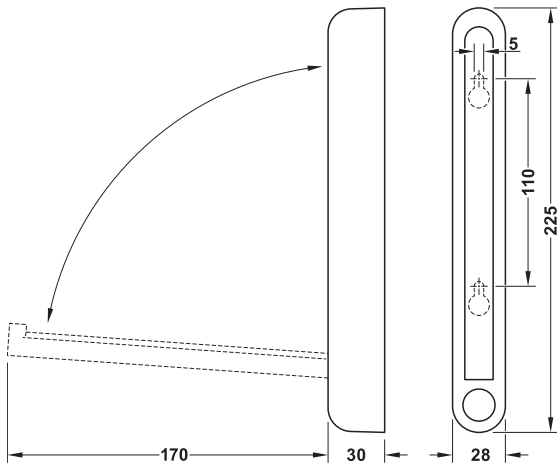

- > Ausführung: Haken klappbar
- > Werkstoff: Gehäuse: Kunststoff,  
Haken: Zinkdruckguss
- > Oberfläche: Haken: verchromt

Farbe	Breite A mm	Tiefe mm	Höhe C mm	Artikel-Nr.
weiß	2.8	3/20 ausgeklappt	22.5	844.12.220
anthrazit	2.8	3/20 ausgeklappt	22.5	844.12.221

Abpackung: 1 Stück



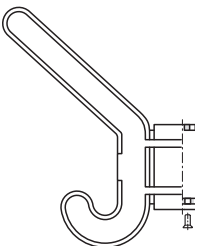
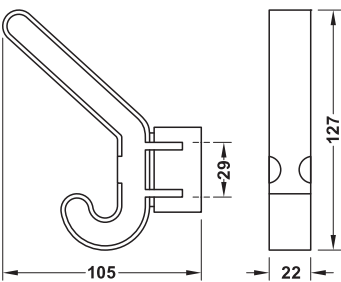
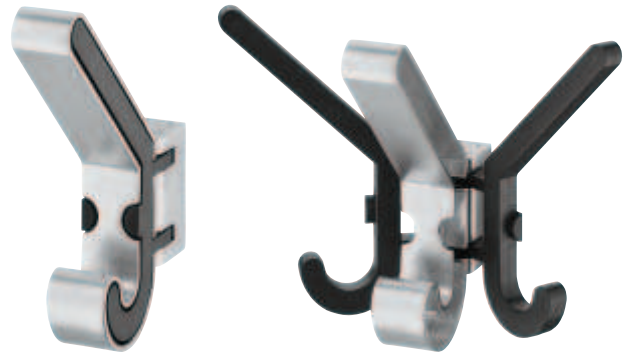
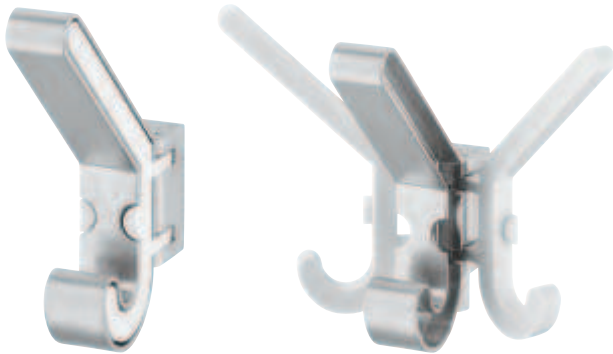
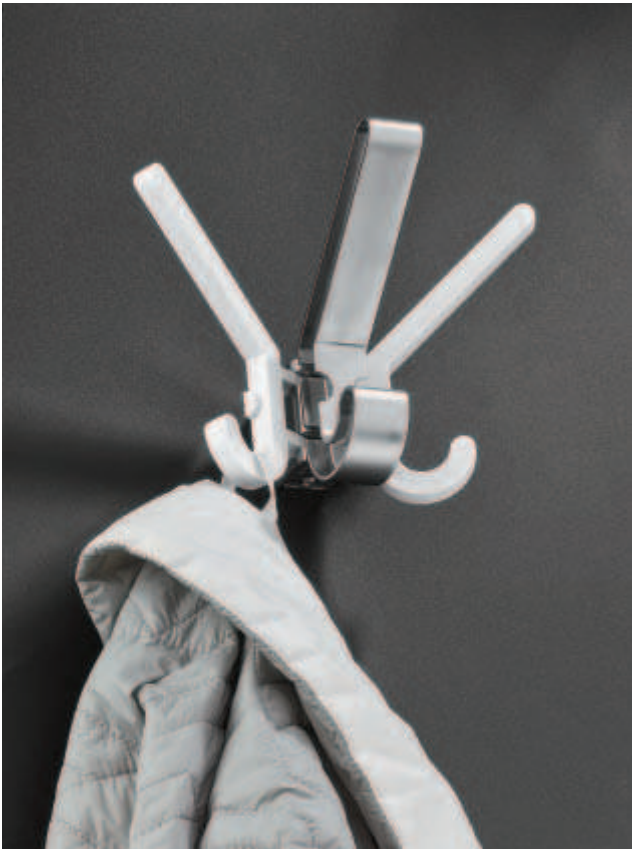

- > Ausführung: Haken schwenkbar
- > Werkstoff: Gehäuse: Zinkdruckguss, Haken: Kunststoff
- > Oberfläche: Gehäuse: matt verchromt

Farbe	Breite mm	Tiefe B mm	Höhe C mm	Artikel-Nr.
schwarz	2/17 ausgeklappt	11	13	844.12.230
weiß	2/17 ausgeklappt	11	13	844.12.231

Abpackung: 1 Stück

DGH-M 2018, HIDE-de, 06/18; Maßangaben unverbindlich. Konstruktionsänderungen vorbehalten.

1

Garderobenhaken



> Werkstoff: Kunststoff  
> Farbe: schwarz

Breite A mm	Tiefe B mm	Höhe C mm	Artikel-Nr.
<b>Mantelhaken</b>			
23	40	70	843.18.605
<b>Hut- und Mantelhaken</b>			
23	98	160	843.17.608

Abpackung: 1 oder 100 Stück

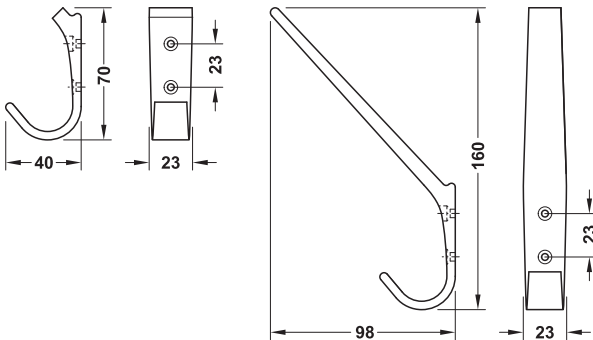

Linsensenkopfschrauben Hospa Ø 4 mm

► MB 14.47

DGH-M 2018; HDE-de, 06/18; Maßangaben unverbindlich. Konstruktionsänderungen vorbehalten.

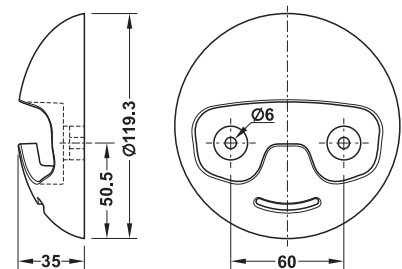

DGH-M 2018, HDE-de, 06/18; Maßangaben unverbindlich. Konstruktionsänderungen vorbehalten.

**Lieferumfang**

- 1 Garderobenhaken
- 2 schwarze Spanplattenschrauben 4 x 40 mm
- 2 schwarze Gewindeschrauben M4 x 18 mm
- 2 schwarze Gewindehülsen M4 x 20 mm
- 2 schwarze Unterlegscheiben
- 2 Dübel

Farbe	Artikel-Nr.
grün	843.77.010
blau	843.77.810
rot	843.77.910
gelb	843.77.610
lila	843.77.110

Abpackung: 1 oder 25 Stück

1

Garderobenhaken

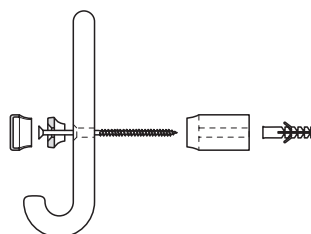
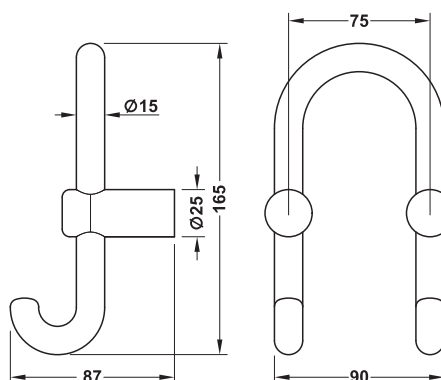
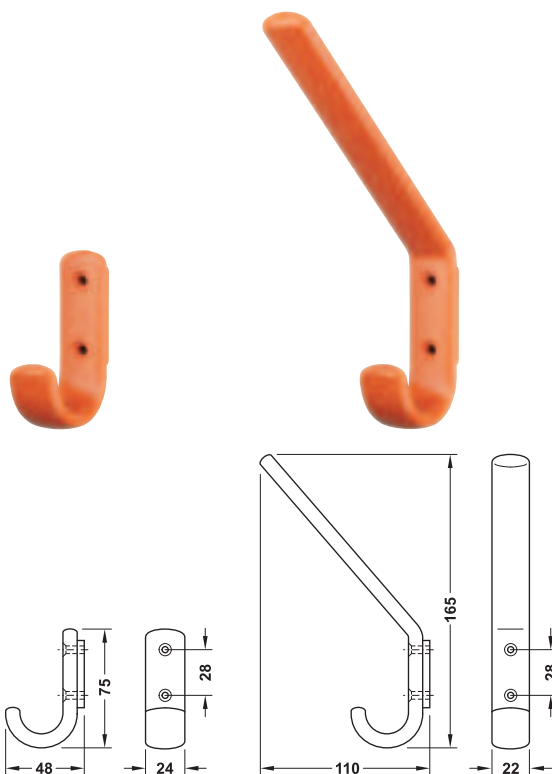

> Werkstoff: Polyamid

> Werkstoff: Polyamid  
> Befestigungsmaterial im Lieferumfang enthalten

Breite A mm	Tiefe B mm	Höhe C mm	verfügbare Farben ab Lager	Artikel-Nr.
<b>Mantelhaken</b>				
24	48	75	33, 90, 92, 95, 97, 99	842.52.1**
<b>Hut- und Mantelhaken</b>				
22	110	165	33, 90, 92, 95, 97, 99	842.54.1**

Breite A mm	Tiefe B mm	Höhe C mm	verfügbare Farben ab Lager	Artikel-Nr.
90	87	165	33, 50, 90, 92, 97, 99	842.84.0**

Abpackung: 1 oder 10 Stück

Abpackung: 1 oder 10 Stück

Linsensenkopfschrauben Hospa Ø 4 mm ▶ MB 1.470

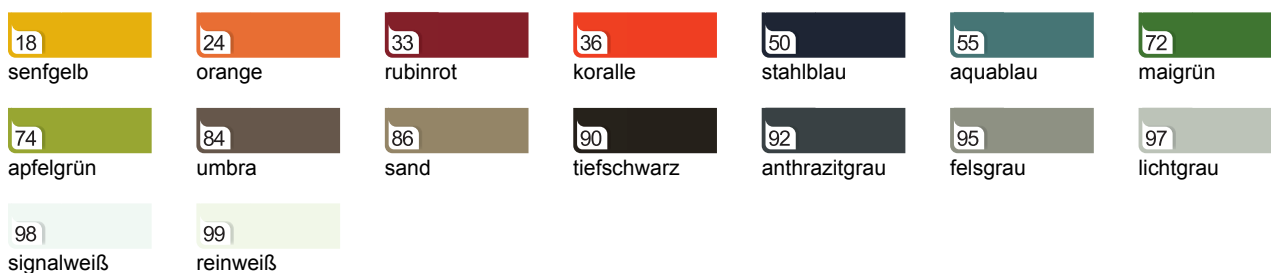

**Bestellhinweis**  
Bei Bestellung die \*\* in der Artikel-Nr. durch die Farb-Nummer Ihrer Wahl ersetzen.

DGH-M 2018; HDE-de, 06/18; Maßangaben unverbindlich. Konstruktionsänderungen vorbehalten.

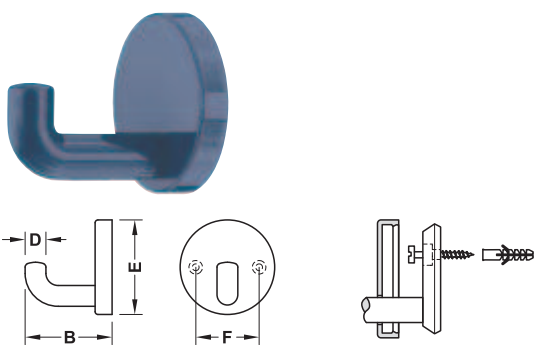

> Werkstoff: Polyamid

Tiefe B mm	Haken-Durchmesser D mm	Rosetten-Durchmesser E mm	Schrauben-Durchmesser mm	Loch-abstand F mm	verfügbare Farben ab Lager	Artikel-Nr.
---------------	---------------------------	------------------------------	-----------------------------	----------------------	----------------------------	-------------

**glänzend**

30	8.5	40	3	26	33, 50, 74, 90, 92, 95, 97, 99	842.61.1**
46	11	50	4	34	33, 50, 74, 90, 92, 95, 97, 99	842.61.2**
65	15	60	5	42	33, 90, 95, 97, 99	842.61.3**
100	20	70	5	50	90, 97, 99	842.61.4**

**matt**

46	11	50	4	34	–	842.61.0**
100	20	70	5	50	–	842.62.3**

Abpackung: 1 oder 10 Stück

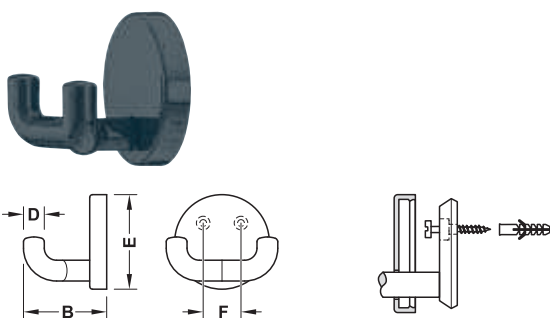

> Werkstoff: Polyamid

Tiefe B mm	Haken-Durchmesser D mm	Rosetten-Durchmesser E mm	Schrauben-Durchmesser mm	Loch-abstand F mm	verfügbare Farben ab Lager	Artikel-Nr.
---------------	---------------------------	------------------------------	-----------------------------	----------------------	----------------------------	-------------

**glänzend**

31	8.5	40	4	20	–	842.62.9**
44	11	50	4	22	33, 50, 74, 90, 92, 95, 97, 99	842.62.2**

**matt**

44	11	50	4	22	–	842.62.0**
----	----	----	---	----	---	------------

Abpackung: 1 oder 10 Stück

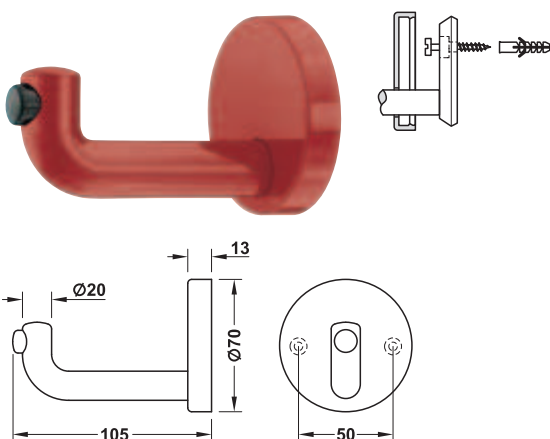

> Werkstoff: Haken: Polyamid, Türpuffer: Gummi  
> Farbe: Türpuffer: schwarz  
> Ausführung: mit Türpuffer

Tiefe B mm	Haken-Durchmesser D mm	Rosetten-Durchmesser E mm	Schrauben-Durchmesser mm	verfügbare Farben ab Lager	Artikel-Nr.
---------------	---------------------------	------------------------------	-----------------------------	----------------------------	-------------

Abpackung: 1 Stück

### Bestellhinweis

Bei Bestellung ersetzen Sie bitte die \*\* durch die Farb-Nummer Ihrer Wahl.



18  
senfgelb



24  
orange



33  
rubinrot



36  
koralle



50  
stahlblau

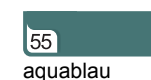

55  
aquablau

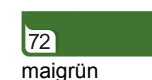

72  
maigrün



74  
apfelgrün



84  
umbra



86  
sand



90  
tiefschwarz



92  
anthrazitgrau



95  
felsgrau



97  
lichtgrau



98  
signalweiß

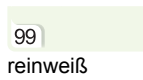

99  
reinweiß

Panheadschrauben Hospa

► MB 1.470



Deckenhaken

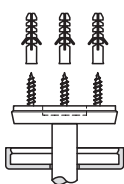
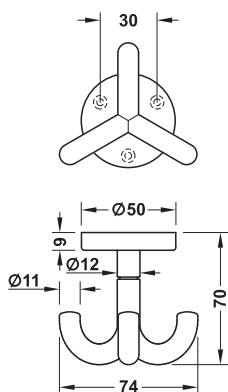

> Werkstoff: Polyamid  
> Ausführung: drehbar

Höhe C mm	Haken- Durch- messer D mm	Rosetten- Durch- messer E mm	Schrauben- Durch- messer mm	verfügbare Farben ab Lager	Artikel-Nr.
70	12	50	4	18, 24, 33, 36, 50, 55, 72, 74, 90, 92, 95, 97, 98, 99	842.65.2**

Abpackung: 1 oder 10 Stück

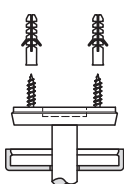
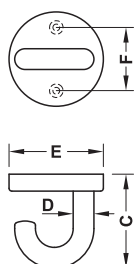

> Werkstoff: Polyamid

Höhe C mm	Haken- Durch- messer D mm	Rosetten- Durch- messer E mm	Schrauben- Durch- messer mm	Loch- abstand F mm	verfügbare Farben ab Lager	Artikel-Nr.
40	8.5	40	4	26	33, 90, 92, 95, 97, 99	842.64.1**
50	11	50	4	34	90, 92, 99	842.64.2**

Abpackung: 1 oder 10 Stück

**Bestellhinweis**

Bei Bestellung ersetzen Sie bitte die \*\* durch die Farb-Nummer Ihrer Wahl.



senfgelb



orange



rubinrot



koralle



stahlblau



aquablau



maigrün



apfelgrün



umbra



sand



tiefschwarz



anthrazitgrau



felsgrau



lichtgrau



signalweiß

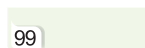

reinweiß

Panheadschrauben Hospa

► MB 1.470

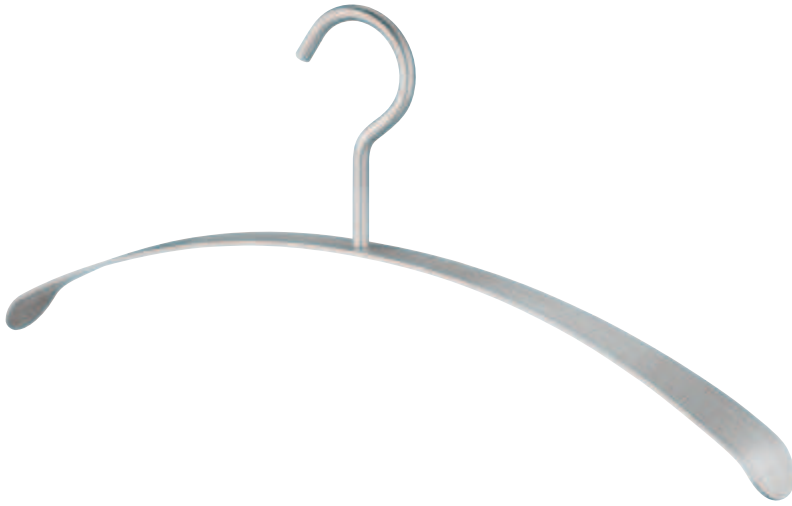

- > Einsatzbereich: zum Einhängen in Stangen bis Durchmesser 40 mm
- > Werkstoff: Edelstahl, Güte 1.4301
- > Oberfläche: matt gebürstet
- > Ausführung: Haken feststehend, Bügel an den Enden breiter

Breite mm	Höhe mm	Querschnitt mm	Artikel-Nr.
457	194	Bügel: 20 x 3	842.45.060

Abpackung: 1 Stück

Kleiderbügel



- > Einsatzbereich: zum Einhängen in Stangen bis Durchmesser 40 mm
- > Werkstoff: Edelstahl, Güte 1.4305
- > Oberfläche: matt gebürstet
- > Ausführung: Haken feststehend

Breite mm	Höhe mm	Querschnitt mm	Artikel-Nr.
460	180	Bügel: 20 x 3	842.45.000

Abpackung: 1 Stück

DGH-M 2018, HIDE-de, 06/18; Maßangaben unverbindlich. Konstruktionsänderungen vorbehalten.



1

Kleiderbügel

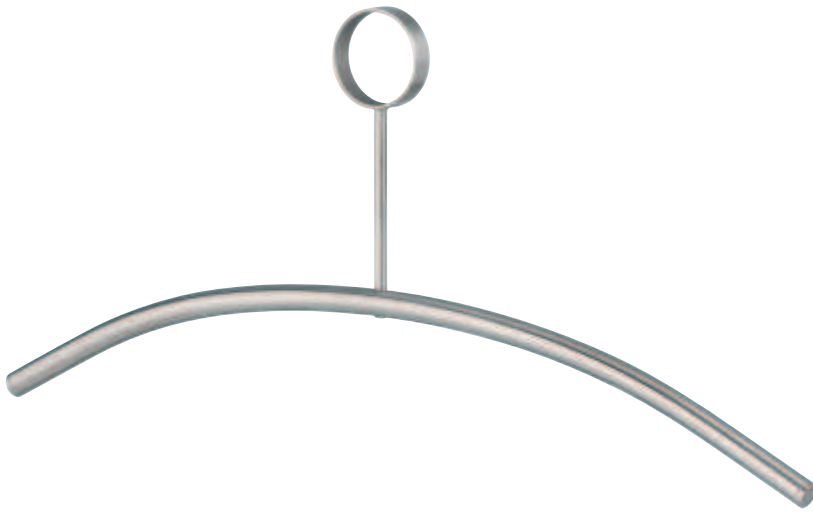

- > Einsatzbereich: zum Einhängen in Stangen bis Durchmesser 40 mm
- > Werkstoff: Edelstahl, Güte 1.4305
- > Oberfläche: matt gebürstet
- > Ausführung: geschlossene Öse, diebstahlsicher, Haken drehbar

Breite mm	Höhe mm	Bügel-Durchmesser mm	Artikel-Nr.
460	202	12	842.36.050

Abpackung: 1 Stück

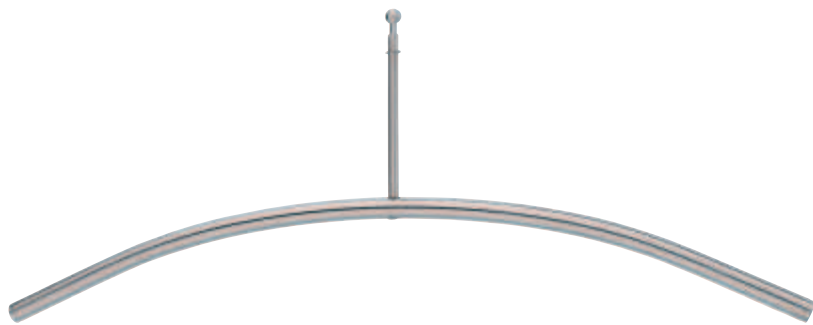

- > Einsatzbereich: zum Einhängen in Kleiderbügellasche
- > Werkstoff: Edelstahl, Güte 1.4305
- > Oberfläche: matt gebürstet
- > Ausführung: mit Hotelstift, feststehend

Breite mm	Höhe mm	Bügel-Durchmesser mm	Artikel-Nr.
460	180	12	842.36.060

Abpackung: 1 Stück

### Kleiderbügellasche



- > Einsatzbereich: passend für OVA Rohre 30 x 15 mm und Rundrohr-Durchmesser 20 mm
- > Werkstoff: Edelstahl, Güte 1.4305
- > Oberfläche: matt gebürstet

Breite mm	Höhe mm	Artikel-Nr.
30	70	842.36.099

Abpackung: 1 oder 10 Stück



- > Einsatzbereich: passend für Rundrohre
- > Werkstoff: Edelstahl, Güte 1.4305
- > Oberfläche: matt gebürstet

Breite mm	Höhe mm	verwendbar für	Artikel-Nr.
35	70	Rohrdurchmesser 20–25 mm	842.36.096
40	70	Rohrdurchmesser 25–30 mm	842.36.097

Abpackung: 1 oder 10 Stück

Schrankrohre

► MB 8.23



- > Einsatzbereich: zum Einhängen in Stangen bis Durchmesser 40 mm
- > Werkstoff: Edelstahl, Güte 1.4305
- > Oberfläche: matt gebürstet
- > Ausführung: Haken feststehend

Breite mm	Höhe mm	Bügel-Durchmesser mm	Artikel-Nr.
460	178	10	842.36.010
460	183	12	842.36.020
460	193	15	842.36.030

Abpackung: 1 Stück

Kleiderbügel



- > Einsatzbereich: zum Einhängen in Stangen bis Durchmesser 40 mm
- > Werkstoff: Edelstahl, Güte 1.4305
- > Oberfläche: matt gebürstet
- > Ausführung: Haken feststehend

Breite mm	Höhe mm	Querschnitt mm	Artikel-Nr.
460	192	10 x 10	842.45.010

Abpackung: 1 Stück

DGH-M 2018, HIDE-de, 06/18; Maßangaben unverbindlich. Konstruktionsänderungen vorbehalten.

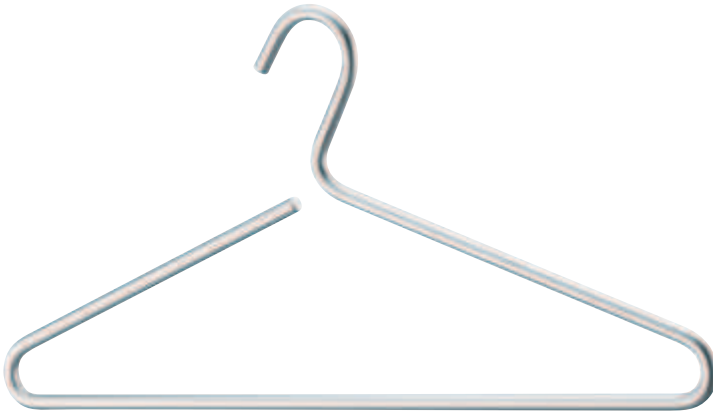

- > Einsatzbereich: zum Einhängen in Stangen bis Durchmesser 40 mm
- > Oberfläche/Farbe: silberfarben eloxiert
- > Ausführung: Haken feststehend

Breite mm	Höhe mm	Bügel- Durchmesser mm	Artikel-Nr.
420	200	8	842.71.795

Abpackung: 1 oder 20 Stück



- > Werkstoff: Aluminium
- > Einsatzbereich: zum Einhängen in Stangen bis Durchmesser 38 mm
- > Oberfläche: silberfarben eloxiert
- > Ausführung: Haken drehbar

Breite mm	Höhe mm	Bügel- Durchmesser mm	Artikel-Nr.
450	175	12	842.91.900

Abpackung: 1 Stück

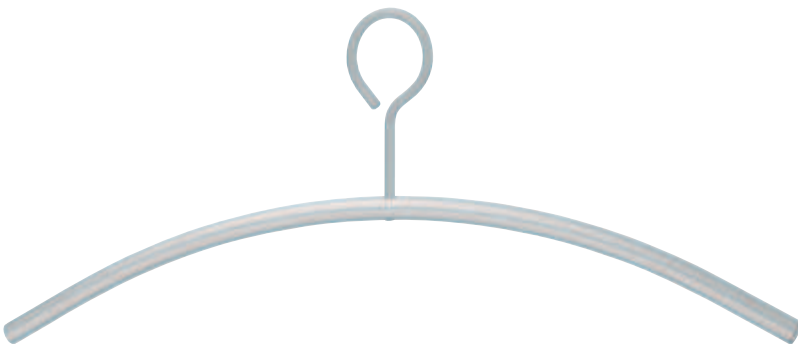

- > Werkstoff: Aluminium
- > Einsatzbereich: zum Einhängen in Stangen bis Durchmesser 40 mm
- > Oberfläche: silberfarben eloxiert
- > Ausführung: geschlossene Öse, diebstahlsicher, Haken drehbar

Breite mm	Höhe mm	Bügel- Durchmesser mm	Artikel-Nr.
450	175	13	842.91.910

Abpackung: 1 Stück



- > Werkstoff: Stahl
- > Einsatzbereich: zum Einhängen in Stangen bis Durchmesser 40 mm
- > Oberfläche: verchromt poliert
- > Ausführung: Haken drehbar

Breite mm	Höhe mm	Bügel- Durchmesser mm	Artikel-Nr.
450	175	13	842.37.200

Abpackung: 1 Stück

Kleiderbügel



- > Werkstoff: Stahl
- > Einsatzbereich: zum Einhängen in Stangen bis Durchmesser 40 mm
- > Oberfläche: verchromt matt
- > Ausführung: Haken drehbar

Breite mm	Höhe mm	Bügel- Durchmesser mm	Artikel-Nr.
450	175	13	842.37.400

Abpackung: 1 Stück

DGH-M 2018, HIDE-de, 06/18; Maßangaben unverbindlich. Konstruktionsänderungen vorbehalten.

1

Kleiderbügel



- > Werkstoff: Stahl
- > Ausführung: mit festem flachen Haken
- > Breite: 450 mm
- > Höhe: 170 mm
- > Bügel-Durchmesser: 13 mm

Oberfläche/Farbe	Artikel-Nr.
verchromt poliert	842.37.210
schwarz	842.37.211

Abpackung: 1 Stück

**DIESE SEITE WURDE BEWUSST  
LEER GELASSEN**

**INTENTIONAL BLANK PAGE**

1

Kleiderbügel



- > Einsatzbereich: zum Einhängen in Stangen bis Durchmesser 40 mm
- > Werkstoff: Bügel: Holz, Haken: Zinkdruckguss
- > Oberfläche/ Farbe: Bügel: weiß hochglänzend, Haken: silberfarben matt
- > Ausführung: Haken drehbar

Breite mm	Höhe mm	Querschnitt mm	Artikel-Nr.
460	170	Bügel: 20 x 15	842.71.770

Abpackung: 1 oder 10 Stück



- > Einsatzbereich: zum Einhängen in Stangen bis Durchmesser 40 mm
- > Werkstoff: Bügel: Eiche, Haken: Zinkdruckguss
- > Oberfläche/ Farbe: Bügel: lackiert, Haken: silberfarben matt
- > Ausführung: Haken drehbar

Breite mm	Höhe mm	Querschnitt mm	Artikel-Nr.
460	170	Bügel: 20 x 15	842.71.440

Abpackung: 1 oder 10 Stück





- > Einsatzbereich: zum Einhängen in Stangen bis Durchmesser 35 mm
- > Werkstoff: Bügel: Holz, Haken: Zinkdruckguss
- > Oberfläche/ Farbe: Bügel: weiß lackiert, Haken: silberfarben
- > Ausführung: Haken feststehend

Breite mm	Höhe mm	Querschnitt mm	Artikel-Nr.
450	170	Bügel: 10 x 3	842.71.780

Abpackung: 1 oder 10 Stück

Kleiderbügel



- > Einsatzbereich: zum Einhängen in Stangen bis Durchmesser 35 mm
- > Werkstoff: Bügel: Holz, Haken: Zinkdruckguss
- > Oberfläche/ Farbe: Bügel: Nussbaum, Haken: silberfarben
- > Ausführung: Haken feststehend

Breite mm	Höhe mm	Querschnitt mm	Artikel-Nr.
450	170	Bügel: 10 x 3	842.71.180

Abpackung: 1 oder 10 Stück

1

Kleiderbügel



- > Einsatzbereich: zum Einhängen in Stangen bis Durchmesser 45 mm
- > Werkstoff: Bügel: Holz, Haken: Stahl
- > Oberfläche/ Farbe: Bügel: weiß hochglanz, Haken: silberfarben matt
- > Ausführung: Haken drehbar

Breite mm	Höhe mm	Artikel-Nr.
440	250	842.71.790

Abpackung: 1 oder 20 Stück



- > Einsatzbereich: zum Einhängen in Stangen bis Durchmesser 35 mm
- > Werkstoff: Bügel: Schichtholz, Haken: Zinkdruckguss
- > Oberfläche: Bügel: Nußbaum Deckfurnier, Haken: verchromt poliert
- > Ausführung: Haken feststehend

Breite mm	Höhe mm	Querschnitt mm	Artikel-Nr.
450	175	Bügel: 40 x 8	842.71.730

Abpackung: 1 oder 10 Stück



- > Einsatzbereich: zum Einhängen in Stangen bis Durchmesser 44 mm
- > Werkstoff: Bügel: Holz, Haken: Stahl
- > Oberfläche/Farbe: Bügel: Zebrano, Haken: verchromt
- > Ausführung: Haken drehbar

Breite mm	Höhe mm	Artikel-Nr.
440	220	842.71.810

Abpackung: 1 oder 20 Stück

Kleiderbügel



- > Einsatzbereich: zum Einhängen in Stangen bis Durchmesser 44 mm
- > Werkstoff: Bügel: Holz, Haken: Stahl
- > Oberfläche/Farbe: Bügel: schwarz, Haken: schwarz
- > Ausführung: Haken drehbar

Breite mm	Höhe mm	Artikel-Nr.
440	220	842.71.815

Abpackung: 1 oder 20 Stück



- > Einsatzbereich: zum Einhängen in Stangen bis Durchmesser 38 mm
- > Werkstoff: Bügel: Holz, Haken: Stahl
- > Oberfläche/ Farbe: Bügel: natur roh geschliffen, Haken: silberfarben matt
- > Ausführung: Haken drehbar

**Hinweis**

Diese Kleiderbügel sind auch mit einer Logo-Beschriftung erhältlich.

Breite mm	Höhe mm	Artikel-Nr.
430	240	842.71.805

Abpackung: 1 oder 10 Stück

**Bestellhinweis**

Logo-Vorlage und Logo-Position inkl. Skizze bitte der Bestellung beifügen. Bitte den gewünschten RAL oder Pantone Farbton angeben.

**Kleiderbügel mit Logo – Topco**



	Artikel-Nr.
einmalige Kosten für Tamponklischee	842.71.998
Druckkosten je Stück	842.71.999

Abpackung: 1 Stück

**Bestellhinweis**

Logo-Vorlage und Logo-Position inkl. Skizze bitte der Bestellung beifügen. Bitte den gewünschten RAL oder Pantone Farbton angeben. Mindestbestellmenge 50 Stück



Die Kleiderbügel sind individuell bedruckbar.



- > Einsatzbereich: zum Einhängen in Stangen bis Durchmesser 40 mm
- > Werkstoff: Bügel: Eiche, Haken: Stahl
- > Oberfläche: Bügel: natur roh geschliffen, Haken: silberfarben matt
- > Ausführung: Haken drehbar

Breite mm	Höhe mm	Artikel-Nr.
430	250	842.71.820

Abpackung: 1 oder 20 Stück

Kleiderbügel

### Kleiderbügel mit Logo – Topco



Die Kleiderbügel sind individuell bedruckbar.

	Artikel-Nr.
einmalige Kosten für Tamponklischee	842.71.998
Druckkosten je Stück	842.71.999

Abpackung: 1 Stück

#### Bestellhinweis

Logo-Vorlage und Logo-Position inkl. Skizze bitte der Bestellung beifügen. Bitte den gewünschten RAL oder Pantone Farbton angeben.  
Mindestbestellmenge 50 Stück

1

Kleiderbügel

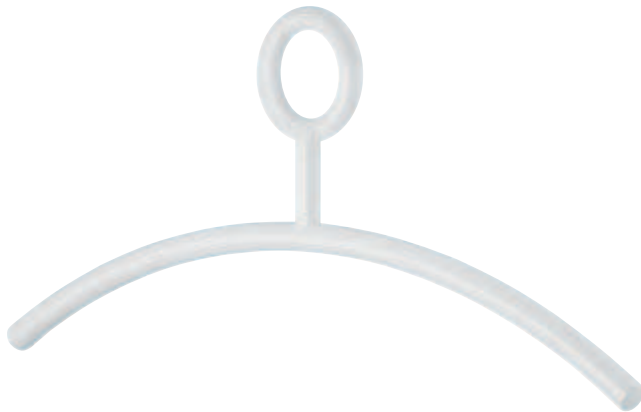
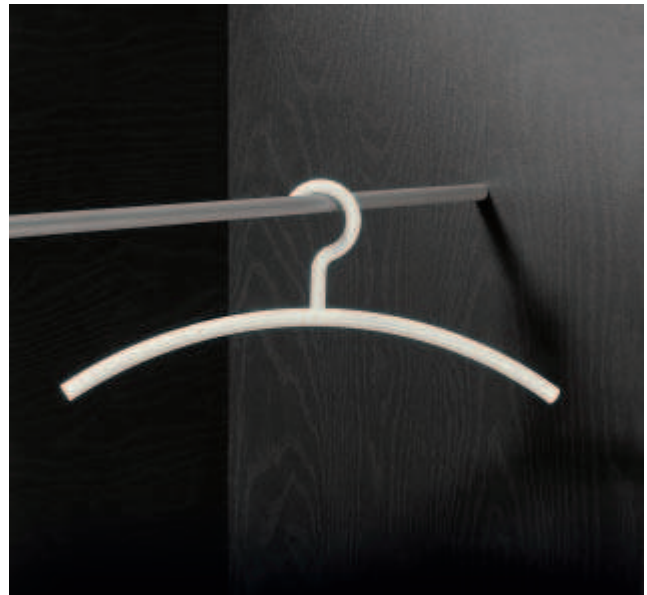
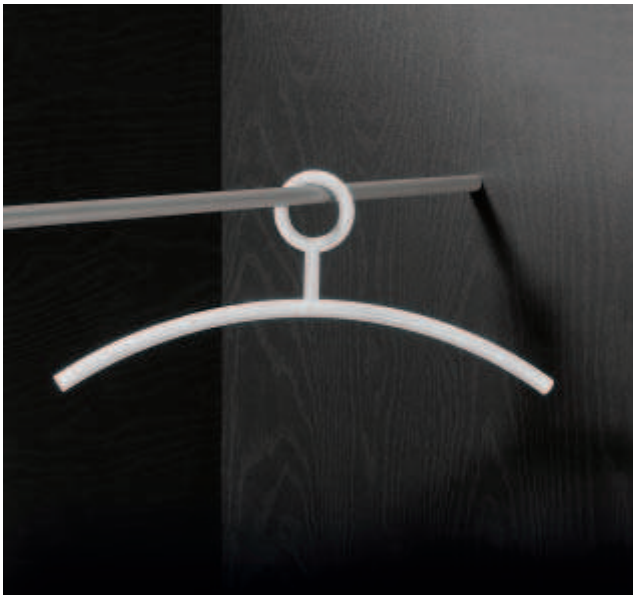

- > Einsatzbereich: zum Einhängen in Stangen bis Ø 33 mm
- > Werkstoff: Polyamid
- > Ausführung: geschlossene Öse, diebstahlsicher, Haken feststehend

Breite mm	Bügel-Durchmesser mm	Ring-Durchmesser mm	verfügbare Farben ab Lager	Artikel-Nr.
450	15	40	90, 99	804.57.1**

Abpackung: 1 Stück

- > Einsatzbereich: zum Einhängen in Stangen bis Ø 33 mm
- > Werkstoff: Polyamid
- > Ausführung: Haken feststehend

Breite mm	Bügel-Durchmesser mm	Haken-Durchmesser mm	verfügbare Farben ab Lager	Artikel-Nr.
<b>glänzend</b>				
450	15	40	33, 90, 92, 95, 97, 99	804.56.1**
<b>matt</b>				
450	15	40	–	804.56.0**

Abpackung: 1 Stück

**Bestellhinweis**

Bei Bestellung ersetzen Sie bitte die \*\* durch die Farb-Nr. Ihrer Wahl.



18  
senfgelb



24  
orange



33  
rubinrot



36  
koralle



50  
stahlblau

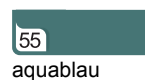

55  
aquablau



72  
maigrün



74  
apfelgrün

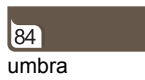

84  
umbra



86  
sand



90  
tiefschwarz

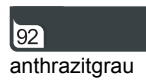

92  
anthrazitgrau

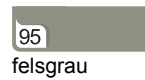

95  
felsgrau



97  
lichtgrau



98  
signalweiß



99  
reinweiß

DGH-M 2018; HDE-de, 06/18; Maßangaben unverbindlich. Konstruktionsänderungen vorbehalten.